



Technology for Vacuum Systems

## Instructions for use



**PC 2001 VARIO**

## Chemistry pumping units with speed control

Technische Beratung

Gebiet Nord:

Telefon: 09342/808-264

Gebiet Mitte:

Telefon: 09342/808-263

Gebiet Süd:

Telefon: 09342/808-225

Kundendienst und Service:

Telefon: 09342/808-209

After sales service: Contact your local dealer or call (++49) 9342/808-193.



Attention! Important notes!



Not permitted! Misuse may cause damage.



Caution! Hot surface!



Isolate equipment from mains.



Note.

# Contents

- ➔ **Safety information!**
  
- ➔ **Technical data**
  
- ➔ **Description**
  
- ➔ **Use and operation**
  - **Notes on operation**
  - **Working with the controller**
  
- ➔ **Troubleshooting**
  
- ➔ **Readjustment**
  
- ➔ **Interface parameters**
  
- ➔ **Replacing diaphragms and valves**
  
- ➔ **Cleaning and assembling components**
  
- ➔ **Notes on return to the factory**
  - Repair - return - DKD calibration
  
- ➔ **Health and safety clearance form**

# Safety information!



Remove all packing material, remove the product from its packing-box, remove the protective covers from the inlet and outlet ports and keep, inspect the equipment. If the equipment is damaged, notify the supplier and the carrier in writing within three days; state the item number of the product together with the order number and the supplier's invoice number. Retain all packing material for inspection.

**Do not use the equipment if it is damaged.**

If the equipment is not used immediately, replace the protective covers. Store the equipment in suitable conditions.

- ☞ **Read and obey this manual before installing or operating the equipment.**
- ☞ Transport the pump at the provided handle.

Use the equipment **for the intended use only** (for generation and measurement of vacuum).

- ☞ **Prevent any part of the human body from coming in contact with vacuum.**
- ☞ Obey notes on correct vacuum and electrical connections, see section "Use and operation".
- ☞ Make sure that the individual components are only connected, combined and operated according to their design and as indicated in the instructions for use.



Obey **national safety regulations and safety requirements** concerning the use of vacuum and electrical equipment.

- ☞ The mains switch for the controller and the pump is at the rear side of the controller.
- ☞ After switching off the pump, wait 60 sec. minimum until next switching on.
- ☞ Equipment must be connected only to a **suitable fused and protected electrical supply** and a suitable earth point. Failure to connect the pumping unit to ground may result in deadly electrical shock.
- ☞ The supply cable may be fitted with a moulded European IEC plug or a plug suitable for your local electrical supply. If the plug has been removed or has to be removed, the cable will contain wires colour coded as follows: green or green and yellow: earth; blue or white: neutral; brown or black: live.
- ☞ Check that mains voltage and current conform with the equipment (see rating plate).
- ☞ If the equipment is brought from cold environment into a room for operation, allow the equipment to warm up (pay attention to water condensation on cold surfaces).
- ☞ Make sure ventilation is adequate if pump is installed in a housing or if ambient temperature is elevated.



Obey all **relevant safety requirements** (regulations and guidelines) and adopt suitable safety measures.

- ☞ Provide a firm level platform for the equipment and check that the system to be evacuated is mechanically stable and that all fittings are secure.  
**Attention:** Flexible elements tend to shrink when evacuated.

Due to the high compression ratio of the pumps, pressure at the outlet port might be generated being higher than the max. permitted pressure compatible with the mechanical stability of the system.

- ☞ Obey **maximum permitted pressures** and pressure differences, see section "Technical data". Do not operate the pump with overpressure at the inlet.



Do not permit any **uncontrolled pressurizing** (e. g. make sure that the exhaust pipeline cannot become blocked). If you have an exhaust-isolation valve, make sure that you cannot operate the equipment with the valve closed. **Risk of bursting!**

- ☞ Ensure that the system design does not allow the exhaust pipeline to become blocked.
- ☞ Max. **permitted pressure at the pressure transducer**: 2 bar (absolute).
- ☞ Ensure that the system design does not allow the coolant outlet pipeline to become blocked.
- ☞ Check the overpressure safety relief device at the exhaust waste vapour condenser in appropriate intervals.
- ☞ Avoid overpressure of more than 0.2 bar in case inert gas is connected.
- ☞ The diameter of the inlet and outlet pipeline should be at the least as large as the diameter of the pump connection pipelines.



To the best of our knowledge the equipment is in compliance with the requirements of the applicable EC-directives and harmonized standards (see “Declaration of conformity”) with regard to design, type and model, especially directive IEC 1010. This directive gives in detail conditions, under which the equipment can be operated safely (see also IP degree of protection).

- ☞ Adopt suitable measures in case of differences, e. g. using the equipment outdoors, installation in altitudes of more than 1000 m above mean sea level, conductive pollution or dewiness.



Pay attention to symbol “hot surfaces“ on the equipment (according to IEC 1010 recommendation).

- ☞ Adopt suitable measures to prevent any danger arising from the formation of hot surfaces or electric sparks.



The pumps are **not suitable** to pump **dangerous or explosive gases or explosive or flammable mixtures**. Ensure that the materials of the wetted parts are compatible with the pumped substances, see section “Technical data”.

- ☞ Adopt suitable measures to prevent the release of dangerous, explosive, corrosive or polluting fluids.
- ☞ Use inert gas for gas ballast if necessary.
- ☞ The user must take suitable precautions to prevent any formation of explosive mixtures in the pump. In case of a diaphragm crack, mechanically generated sparks, hot surfaces or static electricity may ignite these mixtures.
- ☞ Take adequate precautions to protect people from the effects of dangerous substances, wear appropriate safety-clothing.
- ☞ Obey applicable regulations when disposing of chemicals. Take into consideration that chemicals may be polluted.



The motor is protected by a **temperature sensor at the circuit board**: Current limitation if the temperature at the circuit board is higher than 70°C, switching off the pump if the temperature is higher than 85°C. In case of blockage of the motor (after 10 attempts to start-up) the pump is switched off.

- ☞ If the pump is switched off due to safety measures, manual reset is necessary. Isolate the pump from mains. Eliminate cause of failure before restarting the pump.
- ☞ Avoid high heat supply (e. g. due to hot process gases).
- ☞ Ensure sufficient air admittance if pump is installed in a housing.

Due to the residual **leak rate of the equipment**, there may be an exchange of gas, albeit extremely slight, between the environment and the vacuum system.

- ☞ Adopt suitable measures to prevent contamination of the pumped substances or the environment.



Pumping at **high inlet pressure** may lead to overpressure at the gas ballast valve.

- ☞ Pumped gases or condensate might be pushed out if the valve is open.
- ☞ If an inert gas supply is connected, ensure that the inlet pipeline is not contaminated.

The controller is equipped with a **short circuit proof transformer** with an integrated overload protection (no fuses).

- ☞ Failure of the pump (e. g. by power failure) or connected components, parts of the supply (e. g. coolant) or change of parameters (e. g. increase of pressure in the coolant system) must not lead to a critical dangerous situation under any circumstances.



Electronic equipment is never 100% fail-safe. This may lead to an indefinite status of the equipment. Provide protective measures against malfunction and failure.

- ☞ Operating the pump with high or low frequency, stand still of the pump or operating the air admittance valve must not lead to a critical dangerous situation under any circumstances.



Ensure that in case of failure the pump and the vacuum system always will turn into a safe status.

- ☞ In case of diaphragm cracks or leaks in the manifold pumped substances might be released into the environment or into the pump housing. To reduce the risk of leaks, ask for a diaphragm pump with additional safety diaphragm.
- ☞ Obey especially notes on operation and use and maintenance.

Use only **genuine spare parts and accessories**.

- ☞ Otherwise safety and performance of the equipment as well as the electromagnetic compatibility of the equipment might be reduced.



Ensure that maintenance is done only by suitably trained and supervised technicians. Ensure that the maintenance technician is familiar with the safety procedures which relate to the product processed by the vacuum system and that the equipment, if necessary, is appropriately decontaminated before starting maintenance.

Obey local and national safety regulations.

Before starting maintenance vent the system, isolate the pump and other components from the vacuum system and the electrical supply, drain condensate and allow sufficient cooling of the pump.

Before starting maintenance, wait two minutes after isolating the equipment from mains to allow the capacitors to discharge.

**Never operate the pump if covers or other parts of the pump are disassembled. Never operate a defective or damaged pump.**

Repair of the gauge head VSK 5 is not possible.

In order to comply with law (occupational, health and safety regulations, safety at work law and regulations for environmental protection) vacuum pumps, components and measuring instruments returned to the manufacturer can be repaired only when certain procedures (see section “**Notes on return to the factory**”) are followed.

## Technical data

Type		PC 2001 VARIO
Max. pumping speed (according to DIN 28432)	m <sup>3</sup> /h	1.6
Ultimate (total) vacuum (absolute) at 1500 rpm	mbar	2
Ultimate (total) vacuum (absolute) with gas ballast at 1500 rpm	mbar	4
Max. permitted pressure at the outlet (absolute)	bar	1.1
Permitted ambient temperature at storage operation	°C	-10 to +60
	°C	+10 to +40
Permitted relative atmospheric moisture during operation (no condensation)	%	30 to 85
No-load speed*	min <sup>-1</sup>	0 - 2200
Max. current 100 V~ 230 V~	A	2.8
	A	0.85
Power draw 100 V~ 230 V~	VA	280
	VA	200
Max. permitted range of voltage supply <b>(see rating plate!)</b>		100-120 V~ +5/-10% 50/60 Hz 230 V~ +/-10% 50/60 Hz
Motor protection		temperature sensor on the pcb (current limitation)
Degree of protection		IP 20
Inlet		hose nozzle NW 6/10
Outlet		hose nozzle NW 10
Dimensions L x W x H	mm / approx.	320 x 290 x 480
Mass	kg / approx.	10

\* **Note:**

Information: In a motor speed range between **0 and 350 rpm** the pump runs automatically in a tempo-  
ral clocking interval operation.

**We reserve the right for technical modifications without prior note!**

<b>Controller</b>	<b>CVC 2000</b>
Pressure transducer	external, capacitive absolute pressure transducer made of aluminiumoxide ceramic
Electronic scale conversion (to be switched between)	mbar, Torr or hPa
Measurement range	1 mbar - 1100 mbar (1 Torr - 825 Torr)
Max. pressure control range*	1 mbar - 1060 mbar (1 Torr - 795 Torr)
Operation frequency range of the motor	1.0 - 60.0 Hz at steps of 0.5 Hz and additional "HI" (max.75 Hz)
Uncertainty (with transducer carefully calibrated and at constant temperature)	<+/-1 mbar (1 Torr) +/-1 digit
Temperature coefficient	<+/- 0.07 mbar/K (0.05 Torr/K)
Degree of protection pressure transducer according to IEC 529	IP 54
Max. permitted pressure at the pressure transducer (absolute)	2 bar (1500 Torr)
Max. permitted temperature of gaseous media	for short periods up to 80°C
Serial interface	RS 232 C

\* The actual pressure control range in your special application might be reduced due to ultimate vacuum of the pump, quantity of gas occurring etc.

<b>Components</b>	<b>Wetted parts</b>
<b>Pumping unit</b>	
Outlet	PBT
Inlet	PBT
Hose	PTFE
Fitting	ETFE
O-rings at the catchpot	FPM (e. g. Viton®*)
Overpressure safety relief device	silicon rubber
Catchpot cover plate	PE
Exhaust waste vapour condenser, collecting flask	borosilicate glass
<b>Pump</b>	
Housing cover insert	PTFE
Head cover	ETFE
Diaphragm clamping disc	PFA
Valve	FFKM (e. g. Kalrez®*)
Diaphragm	PTFE-NBR (e. g. Perbunan®**) sandwich
<b>VSK 5</b>	
Seal	FPM (e. g. Viton®*)
Pressure transducer housing	PTFE duroplastic reinforced on stainless steel
Pressure transducer	Aluminiumoxide ceramic

\* reg. trade mark Du Pont

\*\* reg. trade mark Bayer AG

**We reserve the right for technical modifications without prior note!**



# PC 2001 VARIO

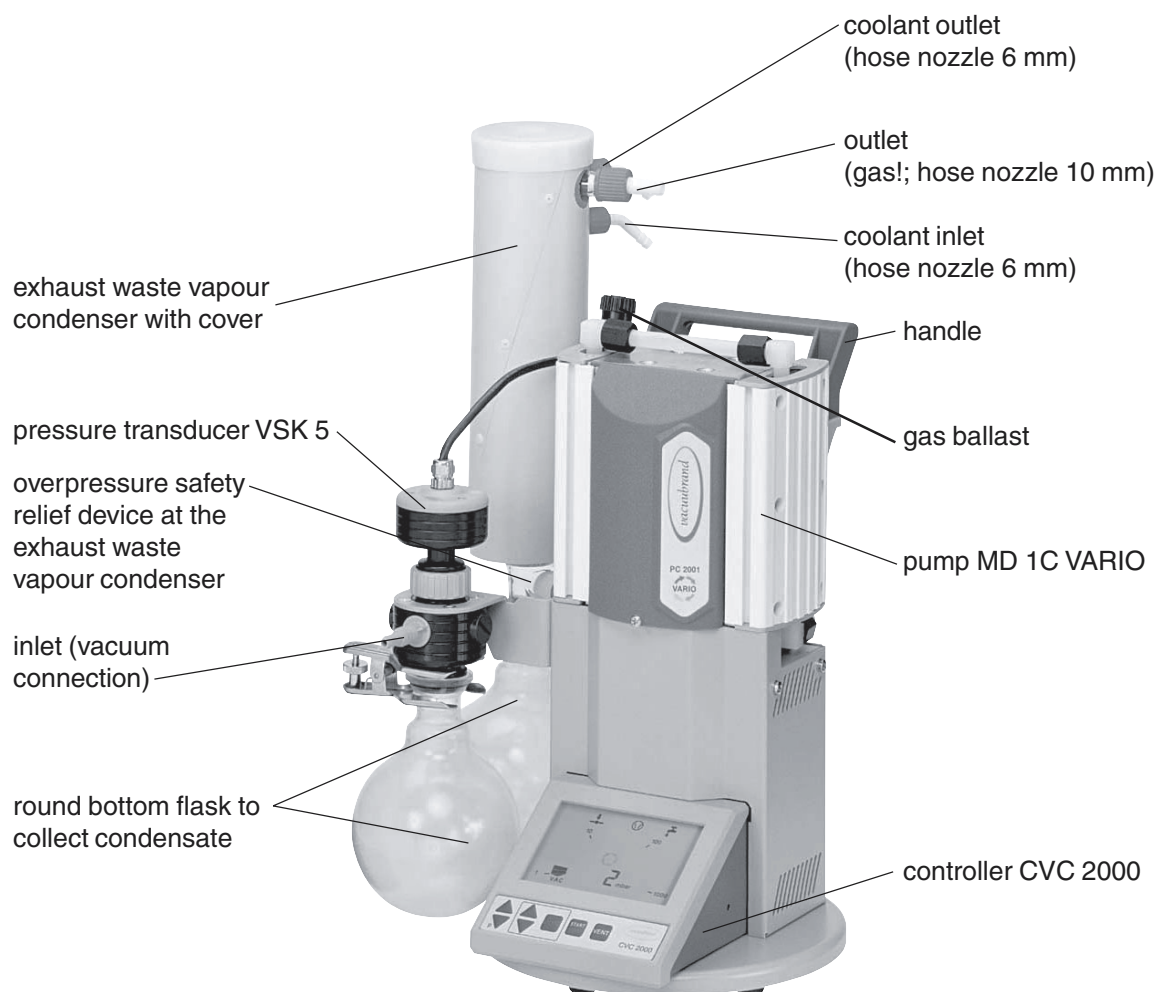

# Description



The controller can be adapted to the specific application by choosing another mode than "Pressure control" (factory-set), see section "General view modes".

The status of the controller respectively of the connected accessories is displayed by corresponding symbols on the LCD. After switching on the **version of the software** is displayed, than the mode as well as the symbols "cooling water valve" and "air admittance valve", if the valves are preselected.

## General view display

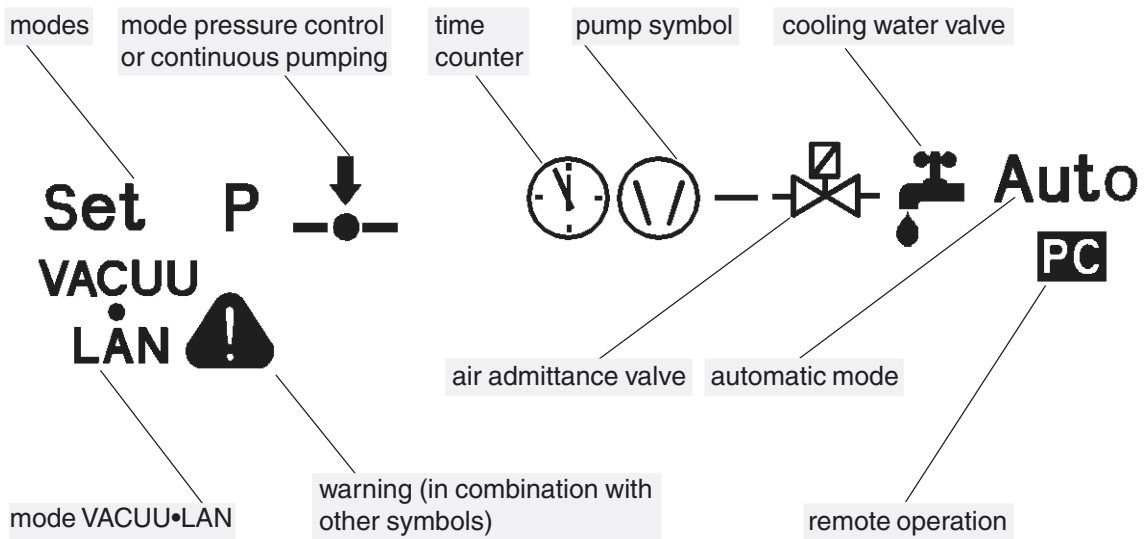

## Pressure reading

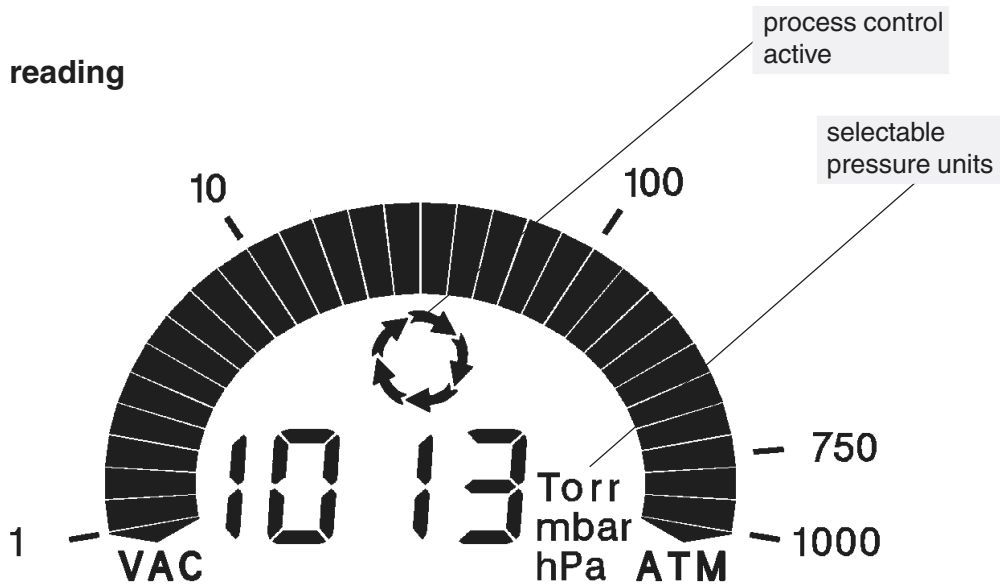

## Keys

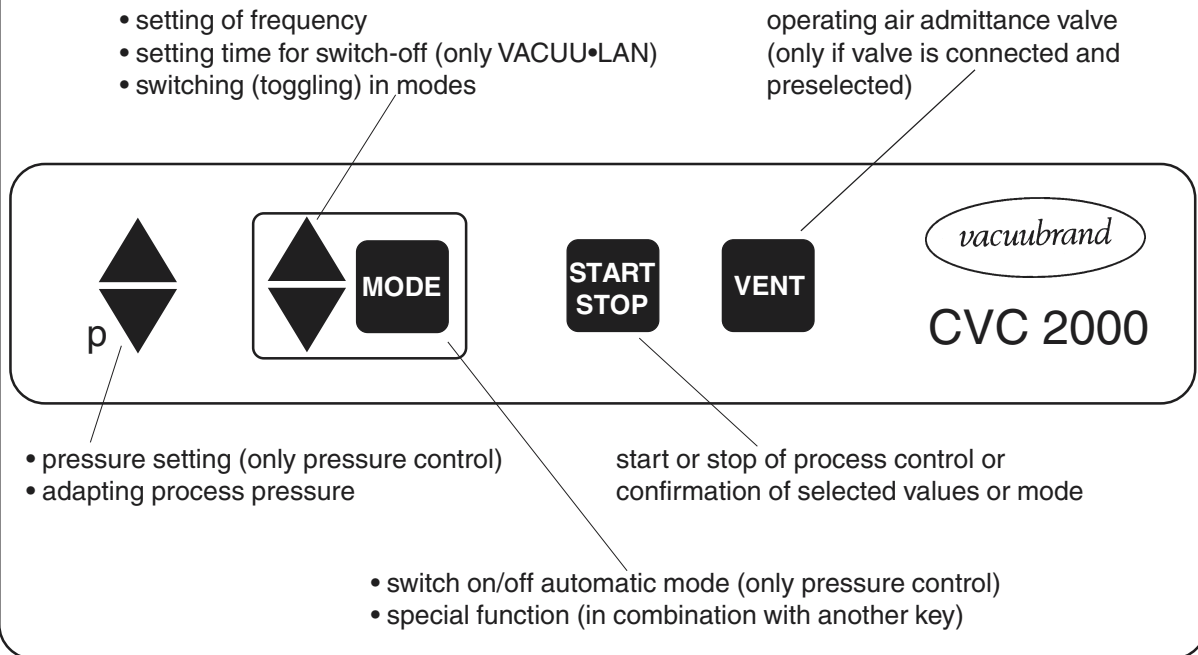

## Rear side CVC 2000

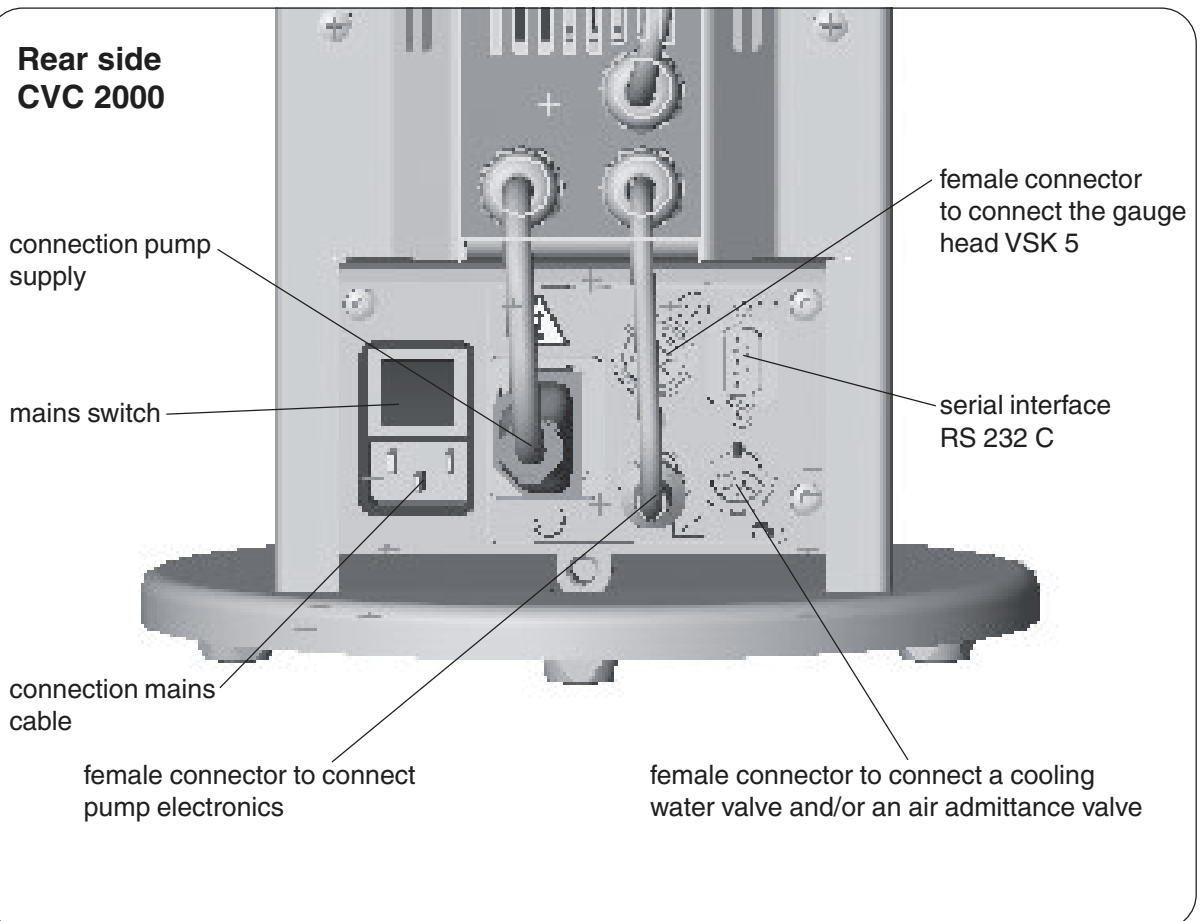

# Use and operation



## Installing in a vacuum system:

- ☞ Avoid throttling losses by using connecting pipes with large diameter and keep them as short as possible.
- ☞ Reduce the transmission of vibration and prevent loading due to rigid pipelines. Insert elastic hoses or flexible elements as couplings between the pump and rigid pipes. **Attention:** Flexible elements tend to shrink when evacuated.
- ☞ Use a suitable valve to isolate the pump from the vacuum system to allow the pump to warm up before condensable vapours are pumped or to clean the pump before it is switched off.
- ☞ Connect the exhaust to a suitable treatment plant to prevent the discharge of dangerous gases and vapours to the surrounding atmosphere. Use a catchpot to prevent the drainage of contaminated condensate back into the pump.



## Prior to use:

- ☞ **Max. ambient temperature:** 40 °C
- ☞ Make sure ventilation is adequate if pump is installed in a housing or if ambient temperature is elevated.
- ☞ If pump is installed in altitudes of more than 1000 m above mean sea level check compatibility with applicable safety requirements, e. g. DIN VDE 0530 (motor may overheat due to insufficient cooling).
- ☞ When assembling, ensure **vacuum-tightness**. After assembly, check the complete system for leaks.



## During operation:

Do not start or operate the pump if **pressure at the outlet** is higher than **1.1 bar absolute**. Attempts to start or operate the pump at higher pressure may cause blockage and damage of the motor.

- ☞ Obey max. permitted pressure at the outlet and max. permitted pressure difference between inlet and outlet.

The pump achieves its **pumping speed, ultimate total vacuum** and **vapour pumping rate** only at operating temperature (after approx. 15 minutes).

- ☞ Prevent internal condensation, transfer of liquids or dust. The diaphragm and valves will be damaged, if liquids are pumped in significant amounts.
- ☞ Operate the pump with gas ballast valve open to reduce the condensation of pumped media (water vapour, solvents, ....) inside the pump.

The motor is protected by a **temperature sensor at the circuit board:** Current limitation if the temperature at the circuit board is higher than 70°C, switching off the pump if the temperature is higher than 85°C. In case of blockage of the motor (after 10 attempts to start-up) the pump is switched off.

- ☞ If the pump is switched off due to safety measures, manual reset is necessary. Isolate the pump from mains. Eliminate cause of failure before restarting the pump.
- ☞ Avoid high heat supply (e. g. due to hot process gases).
- ☞ Ensure sufficient air admittance if pump is installed in a housing.

## How to change the pressure units

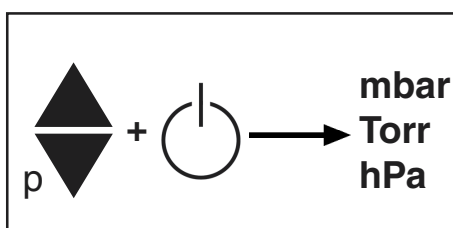

Press key p▲ or p▼ during switching on.

- ☞ The pressure units are displayed, the pressure unit as from last operation is flashing.
- ➔ Press key p▲ or p▼ to change pressure unit. Press key stop when controller displays the desired pressure unit to finish the operation mode.

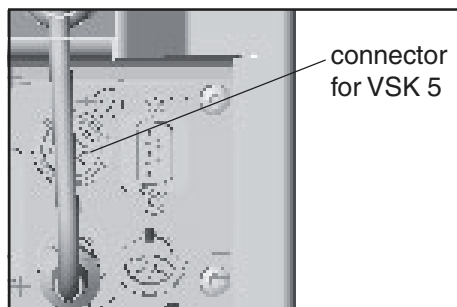

connector for VSK 5

The cable of the gauge head is connected to the female connector at the rear side of the vacuum controller.

The gauge head is connected to the vacuum system with a union nut using an adapter.

- ☞ The device is adjusted together with the gauge head at the factory. If the gauge head is replaced a readjustment is recommended.

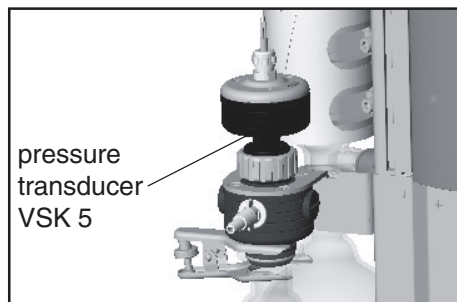

pressure transducer VSK 5

Max. permitted pressure at the pressure transducer: 2 bar (absolute).

- ☞ The display flashes at a pressure higher than 1100 mbar.
- ☞ Obey max. permitted pressure.
- ☞ Inside a vacuum system where evaporation occurs, e. g. rotary evaporator, the vacuum is not uniform, e. g. a condenser acts as pump or the vacuum in the pipeline is lower than in the system. Therefore carefully choose position where to connect the gauge head.

### Notes regarding the assembling of the pressure transducer VSK 5

The pressure transducer can be disassembled from the inlet of the pumping unit and, after having unscrewed the adapter, assembled using a small flange connection or a hose nozzle (included in delivery) directly to the apparatus.

Close the connection at the inlet of the pumping unit using a blind cap (cat. no.: 67 71 50).

- ☞ Condensate and deposits in the pressure transducer affect the measuring result.
- ☞ In case of deposits, aggressive or condensable media, install a gas washing bottle before the pressure transducer if necessary.
- ☞ In order to avoid malfunction it is important to position the pressure transducer in the vacuum line so as to avoid flow of condensate towards the pressure transducer.
- ☞ Clean pressure transducer if necessary, see section "maintenance".

- ☞ Setting of interface parameters, see section "Interface".
- ☞ Preselections at the controller, see section "Modes".
- ☞ Use and operation of the controller see section "How to operate the controller".

### Before operation

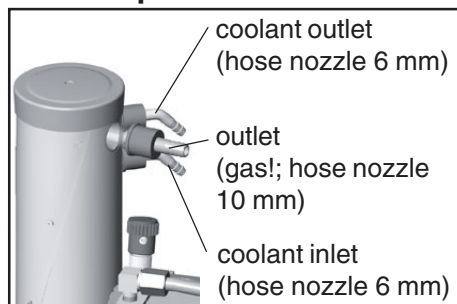

coolant outlet (hose nozzle 6 mm)

outlet (gas!; hose nozzle 10 mm)

coolant inlet (hose nozzle 6 mm)

The exhaust waste vapour condenser enables an efficient condensation of the pumped vapours at the outlet.

- ☞ Next to 100% solvent recovery.
- ☞ The cover protects against glass splinters in the event of breaking, acts as thermal isolation to avoid the condensation of humidity and is intended to absorb shocks.
- ☞ Install hoses for cooling water at the inlet and outlet (hose nozzle 6 mm), check hose connection.
- ➔ **Attention: Install hoses of the cooling system in a way to avoid flow / dropping of condensed water to the pumping unit (especially cables and electronic parts).**
- ☞ Ensure that the system design does not allow the coolant outlet pipeline to become blocked.
- ☞ Ensure that the system design does not allow the exhaust pipeline to be blocked (hose nozzle 10 mm), do not permit uncontrolled pressurizing.
- ☞ Connect the exhaust to a suitable treatment plant to prevent the discharge of dangerous gases and vapours to the surrounding atmosphere.

## During operation:

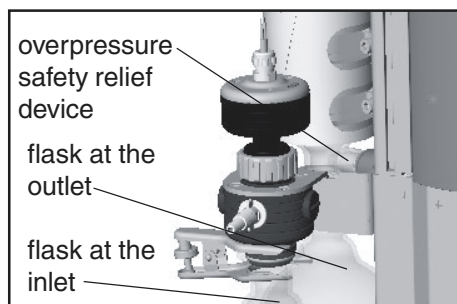

### Separation of condensate:

Both round bottom flasks are coated with a protective layer to prevent disintegration in case of breakage or implosion.

- ☞ Collecting flask at the outlet: Remove joint clip, remove flask and drain condensate.
- ☞ Separator at the inlet: Isolate or shut down the pump, admit air or inert gas to atmospheric pressure. Remove joint clip, remove flask and drain condensate.

**Important:** Obey applicable regulations when disposing solvents. Reuse if possible, purify if contaminated.

Check overpressure safety relief device at the exhaust waste vapour condenser regularly, replace if necessary.

- ☞ Check especially for conglutination and cracks.

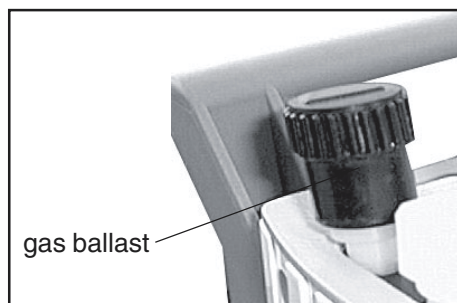

### For **condensable vapours** (water vapour, solvents, ...):

- ☞ Do not pump vapour before pump has reached its operating temperature and with gas ballast valve closed.
- ☞ Open gas ballast valve. Close gas ballast valve by turning 180°.
- ☞ The gas ballast valve is open if the flash on the gas ballast cap shows to the pump.
- ☞ With gas ballast valve open ultimate vacuum will be reduced, pumping speed is decreased.
- ☞ Use inert gas at the air inlet to avoid the formation of explosive mixtures.

In case of low boiling solvents when the formation of condensate is unlikely, the use of gas ballast might be unnecessary.

- ☞ Operating the pump without gas ballast increases the solvent recovery rates at the exhaust waste vapour condenser.



### **Attention: Important notes regarding the use of gas ballast**

- ☞ Make sure that air/gas inlet through the gas ballast valve never leads to hazardous, explosive or otherwise dangerous mixtures. If in doubt, use inert gas.
- ☞ When using air rather than inert gas, risk of significant damage to equipment and/or facilities, risk of personal injury or even loss of life exists due to the formation of hazardous and/or explosive mixtures if air and pumped media react inside or at the outlet of the pump.

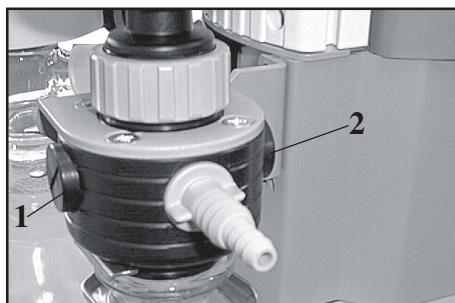

### Hose nozzle (inlet of the pumping unit):

- ☞ Alternatively the hose nozzle or a second hose nozzle (included in delivery) can be assembled at position 1 or 2 at the inlet of the pumping unit.
- ➔ Change closing screw and hose nozzle. Ensure that the O-ring is correctly positioned.



## **Shutdown:**

### **Short-term:**

Has the pump been exposed to condensate?

- ☞ Allow the pump to continue to run at atmospheric pressure for a few minutes (continuous pumping at a setting of 60).

Has the pump been exposed to media which may damage the pump materials or forms **deposits**?

- ☞ Check and clean pump heads if necessary.

Has the pressure transducer been exposed to media which may form deposits?

- ☞ Clean pressure transducer if necessary.

### **Long-term:**

- Take measures as described in section short-term shutdown.
- Separate pump from the apparatus.
- Close inlet and outlet port (e. g. with transport caps).
- Store the pump in dry conditions.

# General view modes

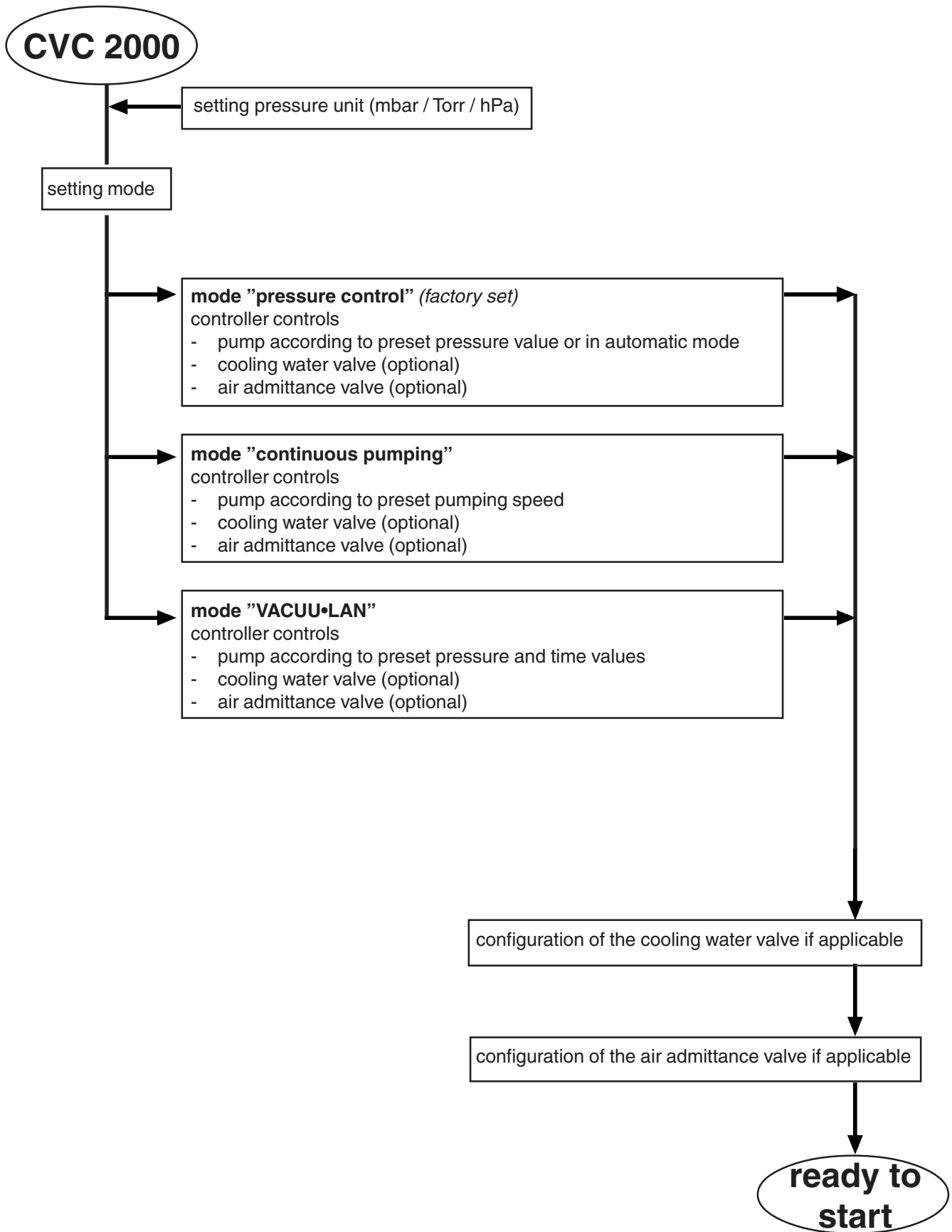



# How to configurate the controller



The controller CVC 2000 can be adapted to the specific application by choosing the appropriate mode, **pressure control with or without automatic, continuous pumping with preset pumping speed or VACUU•LAN**: The components of the chemistry vacuum system (cooling water valve, air admittance valve) have to be preset once only. The mode as from last operation and the preselected values (e. g. for pressure, speed or time for switching off) are stored. In case of similar operation conditions it is possible to start immediately, if the preselections are chosen appropriately.

The vacuum controller CVC 2000 offers three modes depending on

- the components of the VACUUBRAND chemistry vacuum system which are connected to the system.
- the specific user and/or process requirements.

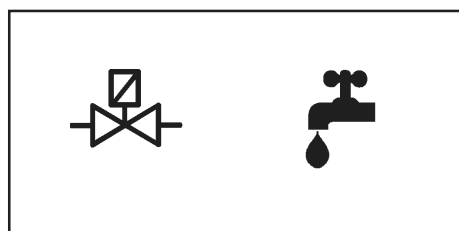

## In all modes:

- ☞ If cooling water and/or air admittance valve have been connected and preselected:
  - ➔ Process-adapted operation of the cooling water valve.
  - ➔ Key-driven venting or adjustment of the set point by venting if process control is active.

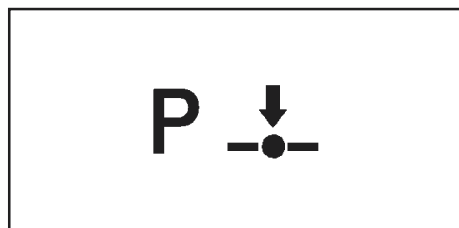

## Pressure control:

- ➔ Position control on preset pressure value.
- ➔ The pumping speed is adapted to the occurring gas/vapour, so that the preset pressure value is kept constantly.
- ➔ Operating in equilibrium by continuous adaption of the controller, no abrupt switching of valves.

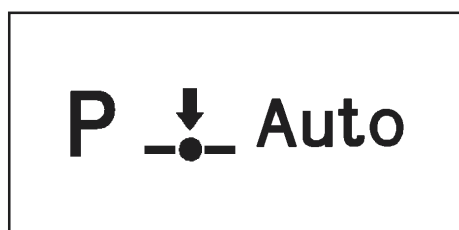

## Pressure control in automatic mode:

- ➔ Searching the boiling point and adjusting the set point automatically if the boiling point changes (due to temperature change, change of ingredients of solutions).
- ➔ Adjusting the set point automatically after manual setting of the boiling point (additional automatic mode in operation mode pressure control).
- ➔ Automatic switching off after complete evaporation of the solvent if preselected.

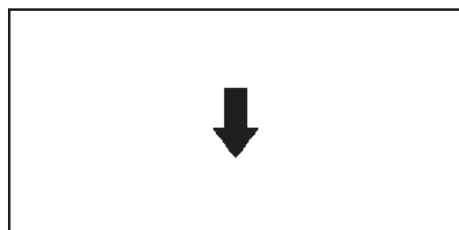

## Continuous pumping with preset pumping speed:

- ➔ Simple suction, suck liquids by siphon, drying, sucking off excess, etc.
- ➔ Suction with regulated pumping speed.
- ➔ Pumping down until the ultimate vacuum of the pump is achieved (e. g. to dry a system).
- ➔ System controlled by an interface: temporally variable pumping speed to optimize the process conditions (e. g. to dry sensitive substances).
- ➔ Einstellung "HI": Optimum pumping speed at every pressure.



**VACUU•LAN:**

- ➔ The mode for decentralized vacuum network systems (for vacuum in laboratories, vacuum lines for weekend, night or trainee operations). Continuous vacuum without continuous pumping.
- ➔ The cooling water is switched off if no more pumping is required, switched on again if gas or vapour occur.
- ➔ Vacuum supply according to the requirements for lock chambers or pumping systems not compressing against atmospheric pressure, e. g. wide range turbomolecular pumps or cryo pumps.
- ➔ Additional extension of the lifetime of diaphragms and valves.

**Setting the mode**

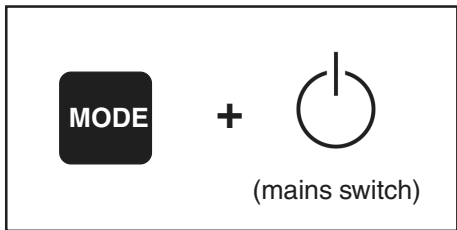

**Starting the program:**

- ➔ Press key MODE while switching on the controller.
- ☞ The mode “pressure control” (factory-set) is displayed on the LCD by flashing symbols.

**To change the mode:**

- ➔ Press key ▲ or ▼ until the symbol of the desired mode is flashing.

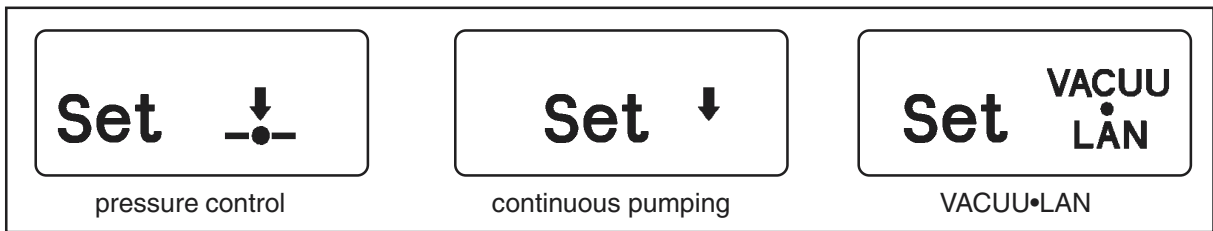

- ➔ Press key START/STOP to confirm the selected mode.



**After selecting the mode:**

- ☞ The symbol of the **cooling water valve** is displayed and “yes” or “no”.
- ➔ Switching between “yes” or “no” is possible by pressing key ▲ or ▼.
- ➔ Confirm the selection “yes” or “no” by pressing key START/STOP.



- ☞ The symbol of the **air admittance valve** is displayed and “yes” or “no”.
- ➔ Switching between “yes” or “no” is possible by pressing key ▲ or ▼.
- ➔ Confirm the selection “yes” or “no” by pressing key START/STOP.



**Only in mode “pressure control”:**

- ☞ “Set”, “Auto” and “yes” or “no” are displayed.
- ➔ Switching between “yes” or “no” is possible by pressing key ▲ or ▼.
- ➔ To preselect the automatic mode confirm “yes” by pressing key START/STOP.
- ➔ If you do not wish to preselect the automatic mode confirm “no” by pressing key START/STOP.

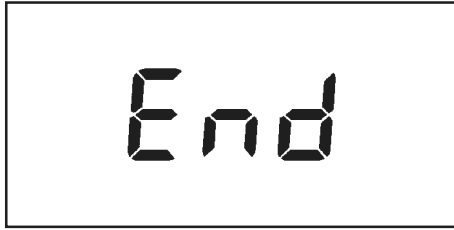

If the automatic mode has been preselected “**End**” is displayed.

- ☞ Switching between automatic switching off activated or not activated is possible by pressing key ▲ or ▼.
- ➡ Confirm by pressing key START/STOP.
- ☞ The controller switches to normal operation mode (process control not active).
  
- ☞ Automatic switching off as soon as the controller detected that evaporation is completely finished. The pump is switched off, the cooling water is running on, if a cooling water valve is preselected.
- ☞ Without automatic switching off, the pressure in the vacuum system is adjusted after evaporation is completed if necessary until the ultimate vacuum of the system.

# General view mode pressure control

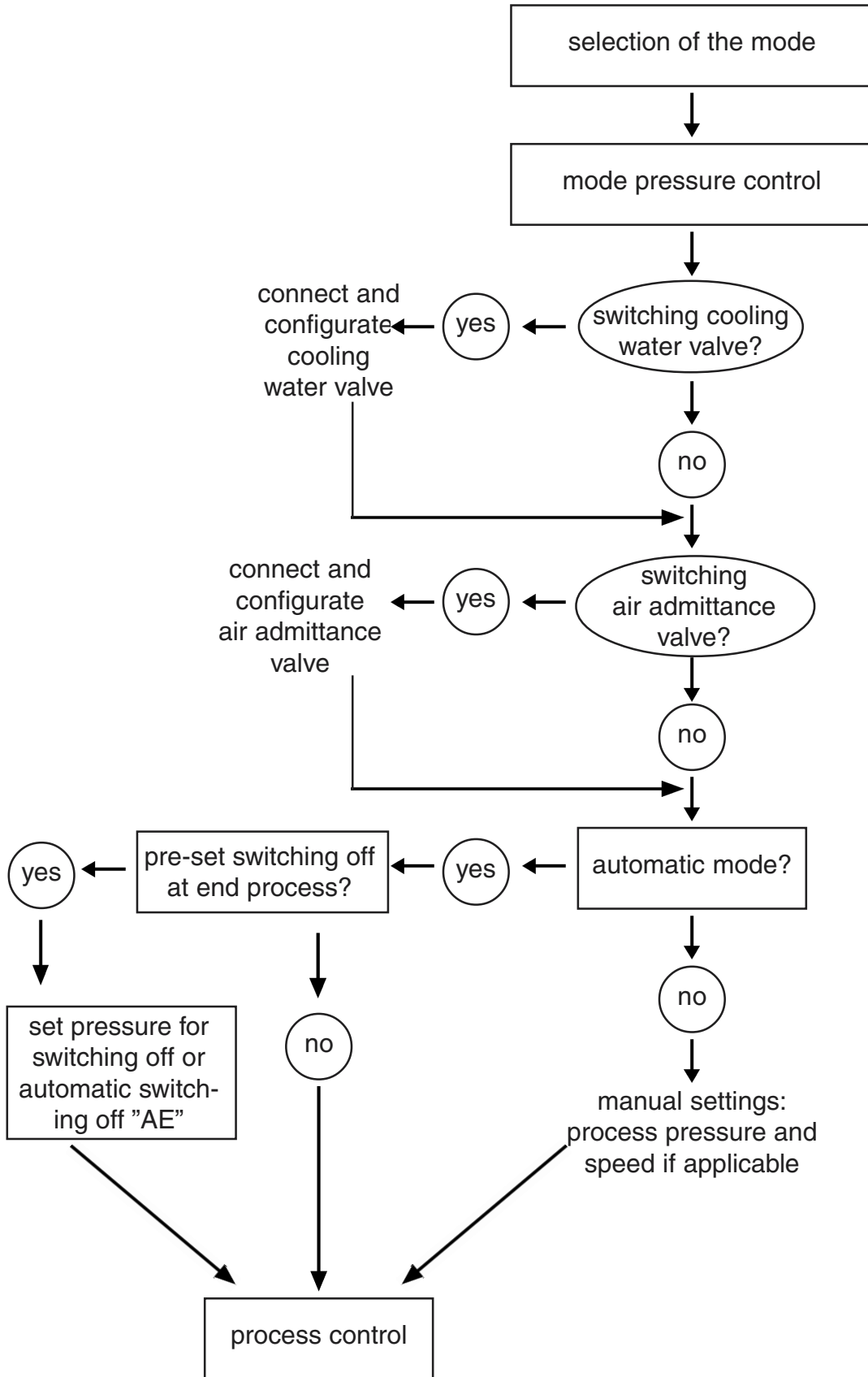

# Mode pressure control

## After switching on

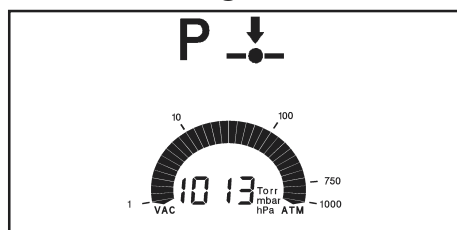

The process control is not active, i. e. the controller is ready for vacuum control, but control operation has not been started.

- ☞ The mode as from last operation is reactivated (after first switching on “pressure control” (factory-set) is displayed).
- ☞ The actual pressure is displayed.
- ☞ Values as from last operation are reactivated.
- ☞ Press key START/STOP to start process control.

☞ A cooling water valve has to be preselected, see section ” Setting the mode”.

## Starting and stopping the process control

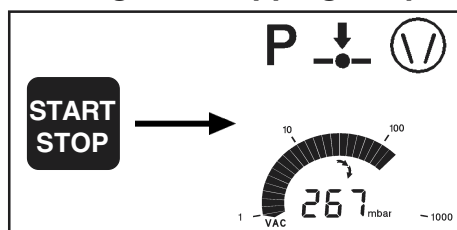

- **Starting** process control: Press key START/STOP.
- ☞ If a cooling water valve is preselected: Cooling water valve opens immediately, the symbol is displayed.
- **Stopping** process control: Press key START/STOP.
- ☞ The pump is switched off.
- ☞ Attention: Adopt suitable measures if there is a possible pressure increase after switching off the pump, e. g. due to low boiling solvents.
- ☞ If a cooling water valve is preselected: The cooling water valve continuous to run for additional 5 minutes to allow condensation of vapours which remain in the system. Symbol “cooling water” is flashing.

## Venting

(only possible if an external air admittance valve is connected and configured)

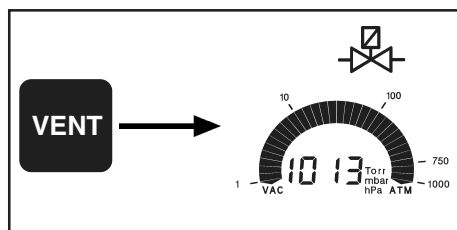

**Attention: If pressurized inert gas is used install an overpressure relief valve. Ensure that high pressure is compatible with the mechanical stability of the system!**

**Short venting**, e. g. in case of boiling retardation or if sudden foaming occurs:

- Press key VENT shortly (< 2 sec.).
- ☞ Pumping is interrupted, the process control is stopped.

**Venting the system:**

- Press key VENT continuously (> 2 sec.) until symbol air admittance valve is flashing.
- ☞ Pumping is interrupted, the process control is stopped.
- ☞ Ventilation until pressure does not change any more, i. e. until atmospheric pressure is attained.
- ☞ Key STOP interrupts venting at any time.

## Setting of set point p (e. g. boiling point)

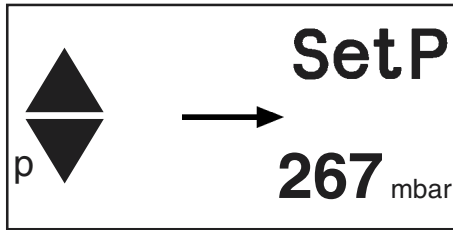

- Setting the set point by using the keys p▲ or p▼ (factory set 100 mbar):
  - ☞ To activate set mode: Press key shortly. "Set p" appears.
  - ☞ Short tips toggle p in steps of 1 mbar
  - ☞ Continuous pressing activates ramp: Set-point changes with increasing speed.

## Adjusting of set point p during pressure control

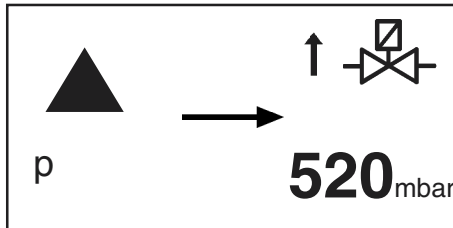

### Adjusting the process pressure upwards

- Press key p▲.
  - ☞ When the key is pressed shortly, the current pressure is displayed for one second.
  - ☞ With a second tip within one second or continuous pressing: The air admittance valve is opened if connected or pressure increase due to system parameters, the current pressure is displayed.
  - ☞ The achieved pressure is stored as new set point when the key is released and adjusted automatically (only in automatic mode).

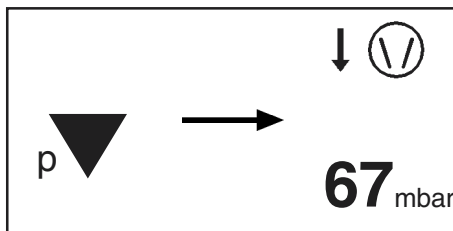

### Adjusting the process pressure by pumping down:

- Press key p▼.
  - ☞ When the key is pressed shortly, the current pressure is displayed for one second.
  - ☞ With a second tip within one second or continuous pressing: Pumping down with preset speed, the actual pressure is displayed and stored as new set point p when the key is released.
  - ☞ The achieved pressure is stored as new set point and adjusted automatically.

## Manual determination of the set point p (e. g. boiling point)

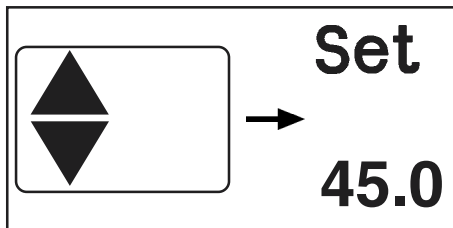

- Setting the value for the speed by using key Mode ▲ or ▼ (factory-set: "HI" = maximum motor speed).
  - ☞ To activate set mode: Press key shortly. The current preset speed is displayed for one second.
  - ☞ With a second tip within one second or continuous pressing: Set speed. The new set point is stored when the key is released.

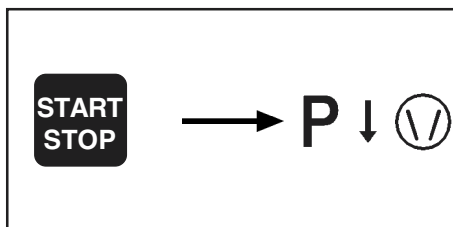

To start process control:

- Start: Press key START and immediately key p▼. Keep key p▼ pressed. Pumping down starts with preselected speed.

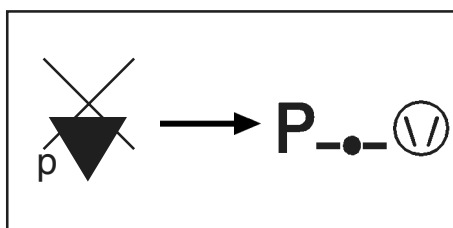

- ☞ Supervise process permanently. When sufficient evaporation appears, release key p▼.
- ☞ The actual pressure is stored as new set point.
- ☞ Pressure control starts.
- ☞ If the **automatic mode** is activated additionally (key MODE) the set point is adjusted automatically in case of change of boiling point.

## Automatic mode



### Additional switching on the automatic mode

- Press key MODE.
- ☞ "Auto" is displayed.
- ☞ After starting process control, the pressure is adapted to the process automatically: The controller determines the pressure and adapts if process parameters change.
- ☞ If automatic mode is switched on while pressure control is active, the process pressure is adapted.

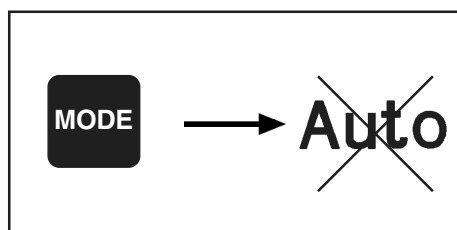

### Switching off the automatic mode

- Press key MODE.
- ☞ Switching off the automatic mode is possible at any time.
- ☞ "Auto" disappears.
- ☞ While pressure control is active the actual pressure is stored as new set point.

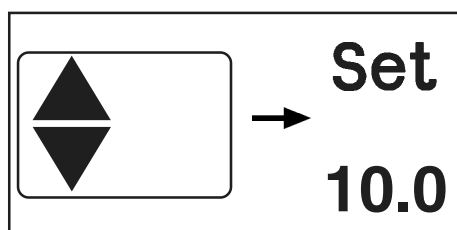

### Setting of maximum speed:

Setting the value for the speed by using key Mode ▲ or ▼:

- ☞ To activate set mode: Press key shortly. The current speed is displayed for one second.
- ☞ With a second tip within one second or continuous pressing:
- ☞ Set speed. The new set point is stored when the key is released.
- ☞ The reduced maximum speed restricts the evaporation rate in case of low boiling solvents and a carry over of substances.
- ☞ The utilisation of a condenser or a cold trap at the inlet can be optimized.
- ☞ If selecting "HI" (recommended) for motor speed the maximum speed for automatic adaption of the motor speed is restricted to a value corresponding to the system size.

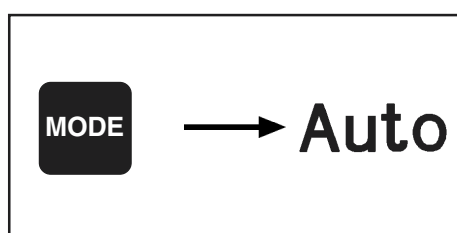

To use the advantages of the automatic mode optimal, switch on "Auto" before starting the process.

- ☞ Switching on automatic mode: Press key MODE.
- ☞ The controller determines the operating pressure.
- ☞ When activating the automatic mode if process control is active (after pressing key START) the actual pressure is stored as new boiling point and adjusted automatically.

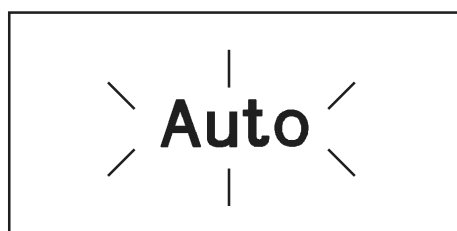

If **automatic switching off** is preselected and the controller determined that evaporation is completely finished:

- ☞ "Auto" is flashing.
- ☞ The pump is switched off. If the controller measures a pressure > 1060 mbar, the pressure is reduced to 1060 mbar to avoid overpressure.
- ☞ The controller is still active, the control must be finished by pressing key STOP or by venting (the cooling water valve will not be closed until then).

## Automatic switching off

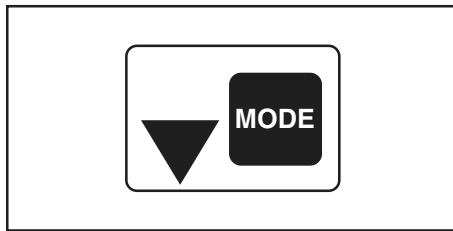

To choose a pressure value for automatic switching off is only possible if automatic switching off is activated (in mode pressure control with automatic).

- ➔ Press key MODE simultaneous with ▼ (arrow down).
- ☞ When the key is pressed shortly, the current pressure for automatic switching off is displayed for one second ("AE", i. e. automatic switching off is preselected at the factory). With a second tip within one second or continuous pressing:

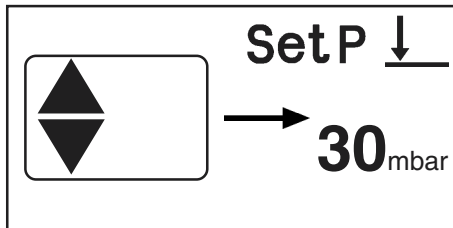

- ➔ Select pressure for automatic switching off by using keys ▲ or ▼ (pressure selectable in a range from 1 to 1060 mbar or "AE"; "AE", i. e. automatic switching off is active if a pressure value < 1mbar is selected).
- ☞ The pressure is stored as new pressure for automatic switching off when the key is released.

## Changing to mode continuous pumping

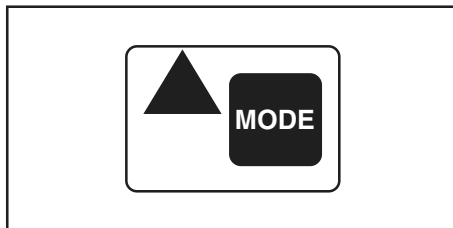

- ➔ Press key MODE simultaneous with ▲ (arrow up).
- ☞ Switching to continuous pumping is only possible, if pressure control is not activated (after pressing key STOP).
- ☞ Adjust the pumping speed choosing an appropriate speed.
- ➔ Press key MODE again to switch to pressure control.
- ☞ Switching to pressure control is only possible, if pumping down is activated (after pressing key START).



# Mode continuous pumping

## After switching on

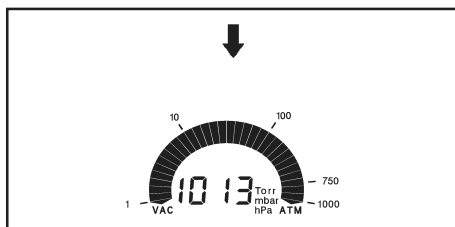

The process control is not active, i. e. the controller is ready for vacuum control, but control operation has not been started.

- The mode as from last operation is reactivated (after first switching on “pressure control” (factory-set) is displayed).
- The actual pressure is displayed.
- Values as from last operation are reactivated.
- Press key START/STOP to start process control.

- A cooling water valve has to be preselected, see section ” Setting the mode”.

## Starting and stopping the process control

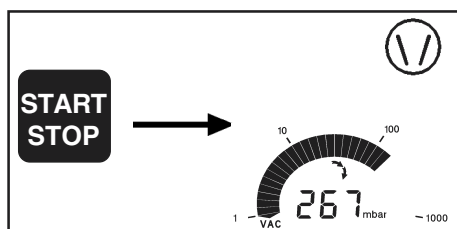

- **Starting process control:** Press key START/STOP.
- If a cooling water valve is preselected: Cooling water valve opens immediately, the symbol is displayed.
- **Stopping process control:** Press key START/STOP.
- The pump is switched off.
- Attention: Adopt suitable measures if there is a possible pressure increase after switching off the pump, e. g. due to low boiling solvents.
- If a cooling water valve is preselected: The cooling water valve continuous to run for additional 5 minutes to allow condensation of vapours which remain in the system. Symbol “cooling water” is flashing.

## Venting

(only possible if an external air admittance valve is connected and configured)

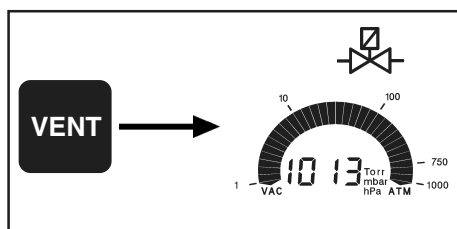

**Attention: If pressurized inert gas is used install an overpressure relief valve. Ensure that high pressure is compatible with the mechanical stability of the system!**

**Short venting**, e. g. in case of radiation of boiling or sudden foaming occurs:

- Press key VENT shortly (< 2 sec.).
- Pumping is interrupted, the process control is stopped.

**Venting the system:**

- Press key VENT continuously (> 2 sec.) until symbol air admittance valve is flashing.
- Pumping is interrupted, the process control is stopped.
- Ventilation until pressure does not change any more, i. e. until atmospheric pressure is attained.
- Key STOP interrupts venting at any time.

## Setting the pumping speed

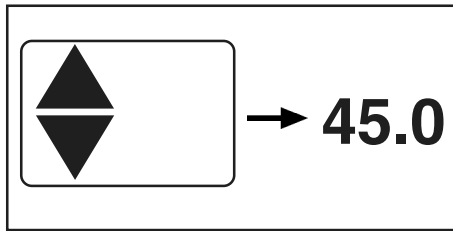

### Setting of speed:

Setting the value for the speed by using key Mode ▲ or ▼:

- ☞ To activate set mode: Press key shortly. The current speed is displayed for one second.
- ☞ With a second tip within one second or continuous pressing:
- ☞ Set speed. The new set point is stored when the key is released.
- ☞ The maximum speed restricts the evaporation rate in case of low boiling solvents and a carry over of substances.
- ☞ Setting the **motor speed "HI"** (above 60 Hz) enables fastest pumping down to the best ultimate vacuum.

## Changing to mode pressure control



- ➔ Press key MODE.
- ☞ Switching to pressure control is only possible, if pumping down is activated (after pressing key START).
- ☞ The actual pressure is stored as new set point, e. i. the controller keeps the pressure constant.
- ☞ Press key MODE again to activate automatic mode.

## General view mode VACUU•LAN

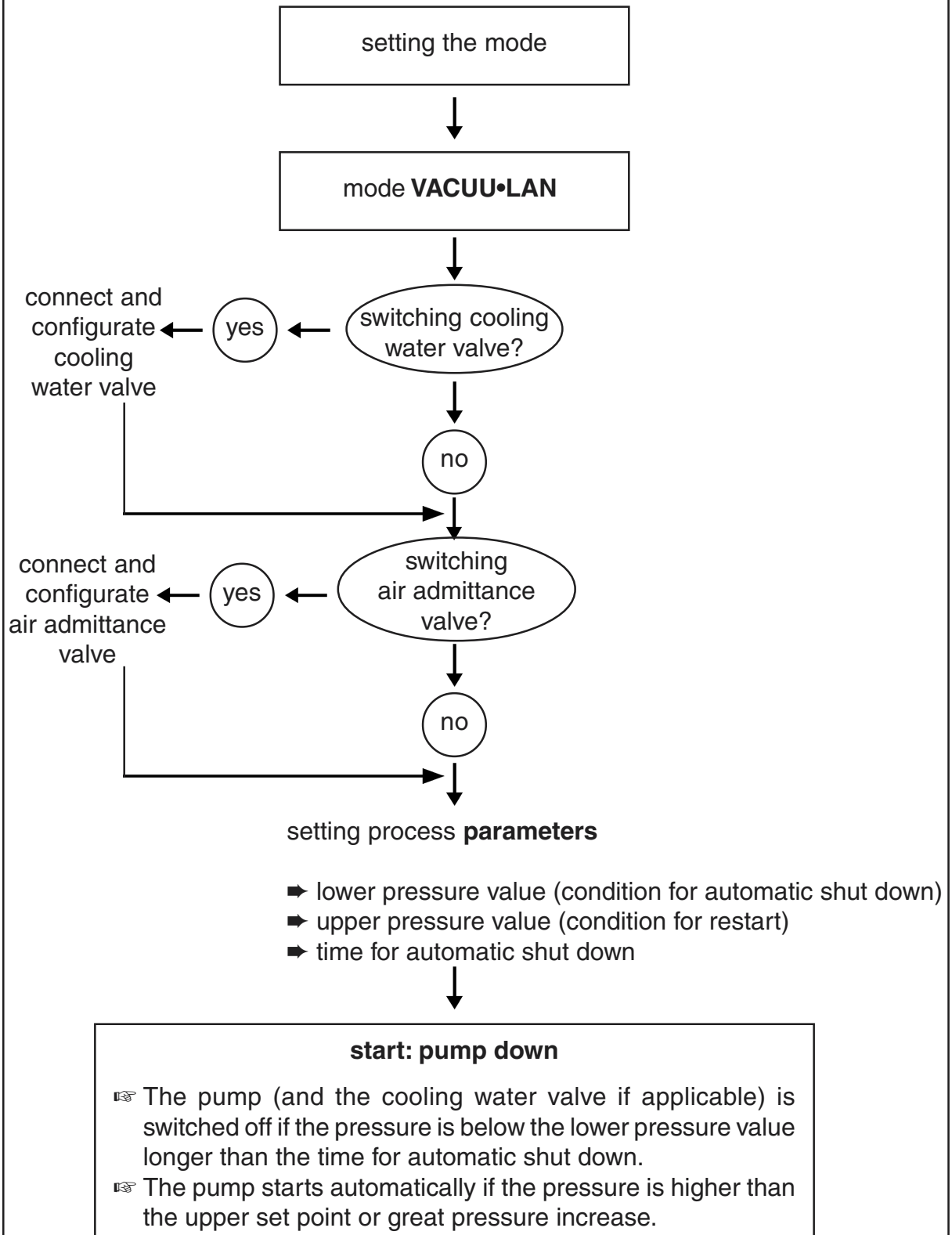

# Mode VACUU•LAN

## After switching on

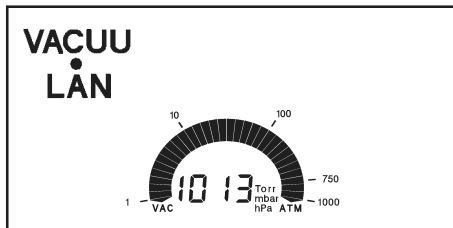

The process control is not active, i. e. the controller is ready for vacuum control, but control operation has not been started.

- ☞ The mode as from last operation is reactivated (after first switching on “pressure control” (factory-set) is displayed).
- ☞ The actual pressure is displayed.
- ☞ Values as from last operation are reactivated (factory-set: time for automatic shut down 60 minutes, pressure value (condition for switching off) 100 mbar, upper set point (condition for restart) 200 mbar).
- ☞ Press key START/STOP to start process control.

- ☞ A cooling water valve has to be preselected, see section ” Setting the mode”.

## Starting and stopping the process control

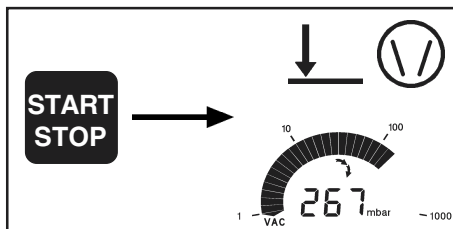

- ➔ **Starting** process control: Press key START/STOP.
- ☞ The pump is switched on.
- ☞ If a cooling water valve is preselected: Cooling water valve opens immediately, the symbol is displayed.
- ☞ If the pressure for switching off is achieved, motor speed becomes reduced.
- ☞ The pump (and the cooling water valve if applicable) is switched off if the pressure is below the lower pressure value longer than the time for automatic shut down.
- ☞ The pump starts automatically if the pressure is higher than the upper pressure value and in case of sudden gas formation.
- ➔ **Stopping:** After pressing key START/STOP or venting the process control stops.
- ☞ The pump is switched off.
- ☞ If a cooling water valve is preselected: The cooling water valve is switched off.

## Venting

(only possible if an external air admittance valve is connected and configured)

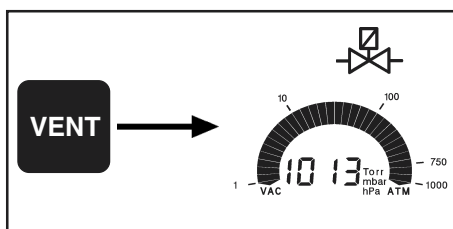

**Attention: If pressurized inert gas is used install an overpressure relief valve. Ensure that high pressure is compatible with the mechanical stability of the system!**

**Short venting**, e. g. in case of radiation of boiling or sudden foaming occurs:

- ➔ Press key VENT shortly (< 2 sec.).
- ☞ Pumping is interrupted, the process control is stopped.

### Venting the system:

- ➔ Press key VENT continuously (> 2 sec.) until symbol air admittance valve is flushing.
- ☞ Pumping is interrupted, the process control is stopped.
- ☞ Ventilation until pressure does not change any more, i. e. until atmospheric pressure is attained.
- ☞ Key STOP interrupts venting at any time.

## Setting the process parameter

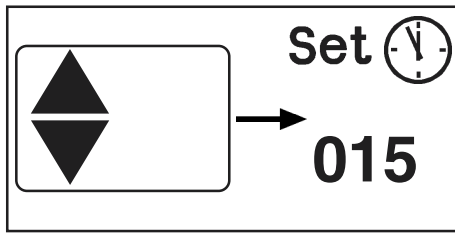

### Setting the **time for automatic shut down**:

- ➔ Press key Mode ▲ or ▼.
- ☞ Set and the clock symbol and the time for automatic shut down are displayed for approx. 1 s.
- ☞ With a second tip within one second or continuous pressing:
  - ➔ Press key Mode ▲ or ▼ to set value for time for shut down (1 - 200 min).
  - ☞ The value for the shut down time is stored as the new set point when the key is released.
  - ☞ If the actual pressure is below the lower set point, the time for automatic shut down is running. Reset of the time for automatic shut down if the actual pressure is higher than the lower set point (with a hysteresis of 3 mbar).

The process control stops when the time for shut down has passed. The vacuum pump and the cooling water valve switch off.

- ☞ Pump starts again in case of great pressure increase.
- ☞ If the actual pressure is higher than the upper set point, the pump starts again (corresponds to starting by pressing key START).
- ☞ The process control can be manually stopped at any time by pressing key STOP.

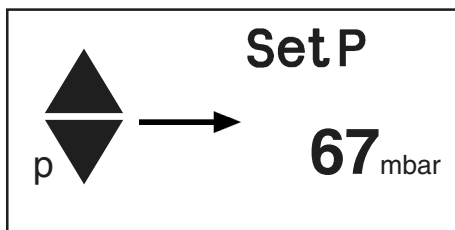

### Setting the **lower pressure value** (condition for automatic switching off):

- ➔ Press p▲ or p▼.
- ☞ Set p and the lower pressure value are displayed for approx. 1 s.
- ☞ With a second tip within one second or continuous pressing:
  - ➔ Set the lower pressure value by pressing key p▲ or p▼.
  - ☞ The lower pressure value is stored as the new set point when the key is released.

*Note: It is recommended to select a pressure value which is approx. 10 mbar higher than the ultimate pressure value achievable in the system.*

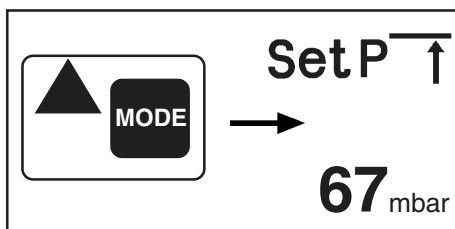

### Setting the **upper pressure value** (condition for restart):

- ➔ While key MODE is pressed, press key Mode and ▲.
- ☞ Set p, arrow up and the upper pressure value are displayed for approx. one second.

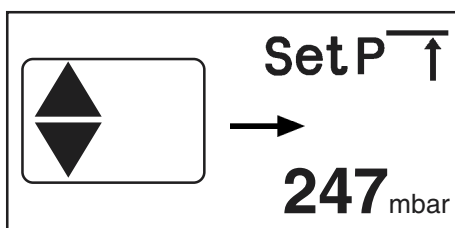

- ☞ With a second tip within one second or continuous pressing:
  - ➔ Set the upper pressure value by pressing key Mode ▲ or ▼.
  - ☞ The upper pressure value is stored as the new set point when the key is released.

# Accessories

## Cooling water minimization



- Cooling water valve 24 V= ..... 67 60 13**
- compact design, designed for a high number of operations at short intervals
  - solenoid systems with splash protection
  - conductance optimized for applications with rotary evaporator and exhaust waste vapour condenser

## Venting

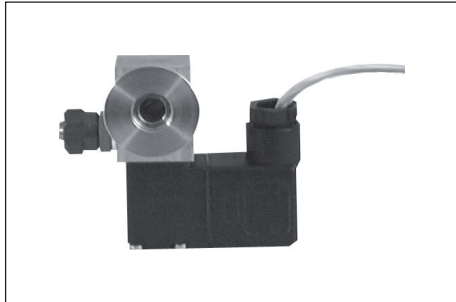

- Solenoid operated air admittance valve  
VB M2 24 V= ..... 66 68 17**

## Vacuum distribution

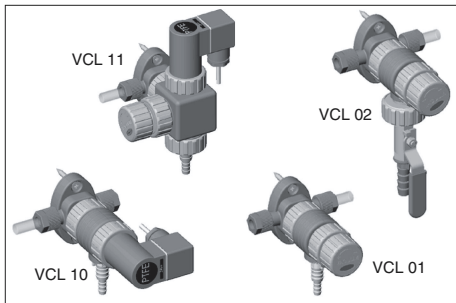



The VACUU•LAN® modules allow process orientated, flexible and cost effective connections according to the requirements: One vacuum pump for multiple work stations.

- VACUU•LAN® manual flow control module VCL 01  
..... 67 71 06**
- VACUU•LAN® shut off-/ manual flow control module VCL 02  
..... 67 71 07**
- VACUU•LAN® automatic control module VCL 10  
..... 67 71 08**
- VACUU•LAN® manual flow control/automatic control module VCL 11  
..... 67 71 09**

On this page we offer only a small selection of VACUU•LAN® options. Please refer for further information.

# Troubleshooting

Fault	Possible cause	Remedy
<input type="checkbox"/> No display.	<ul style="list-style-type: none"> <li>➔ Mains not plugged in?</li> <li>➔ Other cause (device defective)?</li> </ul>	<ul style="list-style-type: none"> <li>☞ Insert mains plug, switch on. Check mains fuse in the building.</li> <li>☞ Return the device to the factory for repair.</li> </ul>
<input type="checkbox"/> Display disappears, internal overload protection becomes actuated.	<ul style="list-style-type: none"> <li>➔ Thermal overload, is ambient temperature too high?</li> <li>➔ Short circuit at the connected valves?</li> <li>➔ Other cause (device defective)?</li> </ul>	<ul style="list-style-type: none"> <li>☞ Make sure ventilation is adequate.</li> <li>☞ Replace valves.</li> <li>☞ Return the device to the factory for repair.</li> </ul>
<input type="checkbox"/> Pressure reading is incorrect.	<ul style="list-style-type: none"> <li>➔ Adjustment has drifted off?</li> <li>➔ Moisture in the pressure transducer?</li> <li>➔ Deposits on the pressure transducer?</li> </ul>	<ul style="list-style-type: none"> <li>☞ Readjust the device.</li> <li>☞ Dry, e.g. by pumping transducer, readjust, use gas washing bottle if necessary.</li> <li>☞ See section maintenance.</li> </ul>
<input type="checkbox"/> Digital pressure display and warning triangle are flashing.	<ul style="list-style-type: none"> <li>➔ Overpressure at the pressure transducer, pressure &gt; 1100 mbar!</li> </ul>	<ul style="list-style-type: none"> <li>☞ Relieve immediately pressure (pressure transducer may suffer damage). Risk of bursting. </li> </ul>
<input type="checkbox"/> Malfunction indicator pressure transducer (warning triangle and "Err").	<ul style="list-style-type: none"> <li>➔ Gauge head not connected?</li> <li>➔ Pressure transducer defective?</li> </ul>	<ul style="list-style-type: none"> <li>☞ Connect gauge head to the female connector at the controller.</li> <li>☞ Use new gauge head.</li> </ul>
<input type="checkbox"/> "PC" is displayed, all keys without function.	<ul style="list-style-type: none"> <li>➔ Controller is in remote operation (only controlled via the interface)?</li> </ul>	<ul style="list-style-type: none"> <li>☞ Switch off remote operation in case, see section "interface".</li> </ul>
<input type="checkbox"/> Warning triangle and pump symbol are flashing.	<ul style="list-style-type: none"> <li>➔ Fault pump electronics?</li> <li>➔ Control line and power supply to the pump electronics not connected?</li> <li>➔ Motor overloaded?</li> <li>➔ Overpressure at the exhaust waste vapour condenser or in the outlet pipeline?</li> <li>➔ Power supply too small?</li> <li>➔ Motor defective or blockage of the pump?</li> </ul>	<ul style="list-style-type: none"> <li>☞ Identify cause of failure (reset of the failure status is only possible by switching off the controller, before restart wait 60s. Contact local distributor if necessary).</li> <li>☞ Check installation of the control line and power supply to the pump electronics.</li> <li>☞ Allow the motor to cool down, identify cause of failure. Then reset the controller by switching off.</li> <li>☞ Open outlet pipeline, make sure that the exhaust waste vapour condenser is not blocked, check overpressure safety relief device.</li> <li>☞ Check power supply. </li> <li>☞ Contact local distributor.</li> </ul>

Fault	Possible cause	Remedy
<input type="checkbox"/> Controller does not react when operating keys. No change after switch off/on.		<ul style="list-style-type: none"> <li>☞ Contact local distributor.</li> </ul>
<input type="checkbox"/> Pump fails to start or stops immediately.	<ul style="list-style-type: none"> <li>➔ Pump has been exposed to condensate?</li> </ul>	<ul style="list-style-type: none"> <li>☞ Allow the pump to run with inlet port open for some minutes at max.speed.</li> </ul>
<input type="checkbox"/> Pump does not achieve ultimate vacuum or normal pumping speed.	<ul style="list-style-type: none"> <li>➔ Incorrect settings at the controller?</li> <li>➔ Centring ring not correctly positioned or leak in the pipeline or vacuum system?</li> <li>➔ Long, narrow line?</li> <li>➔ Pump has been exposed to condensate?</li> <li>➔ Deposits have been formed inside the pump?</li> <li>➔ Diaphragms or valves defective?</li> <li>➔ Outgasing substances or vapour generated in the process?</li> <li>➔ Pump too hot?</li> <li>➔ Pressure for automatic switching off achieved?</li> </ul>	<ul style="list-style-type: none"> <li>☞ Choose operation mode continuous pumping with a frequency of 60 Hz and check again.</li> <li>☞ Check pump with a vacuum gauge directly at pump inlet port, check connections and lines.</li> <li>☞ Use line with larger diameter, length as short as possible.</li> <li>☞ Allow the pump to run with inlet port open for some minutes at max.speed ("HI").</li> <li>☞ Clean and inspect pump heads.</li> <li>☞ Replace diaphragms and/or valves.</li> <li>☞ Check process parameters.</li> <li>☞ Allow the pump to cool down, identify cause of overheating and eliminate.</li> <li>☞ Change pressure for automatic switching off if necessary.</li> </ul>
<input type="checkbox"/> Pump too noisy.	<ul style="list-style-type: none"> <li>➔ Atmospheric or high pressure at the inlet port?</li> <li>➔ Diaphragm clamping disc loose?</li> <li>➔ None of above mentioned causes?</li> </ul>	<ul style="list-style-type: none"> <li>☞ Connect hose to pump outlet.</li> <li>☞ Perform maintenance.</li> <li>☞ Contact local distributor.</li> </ul>
<input type="checkbox"/> Pump seized.		<ul style="list-style-type: none"> <li>☞ Contact local distributor.</li> </ul>



# Readjustment



The vacuum gauge was adjusted using factory standards, which are traceable through regular calibration in an accredited laboratory (German Calibration service) to the national standard. Depending on the process and/or accuracy requirements, check the adjustment and readjust if necessary. For readjustment, the device has to be adjusted both at atmospheric pressure as well as under vacuum.

The adjustment mode can be activated only if the process control is inactive. Press key STOP if necessary.

## Adjustment at atmospheric pressure

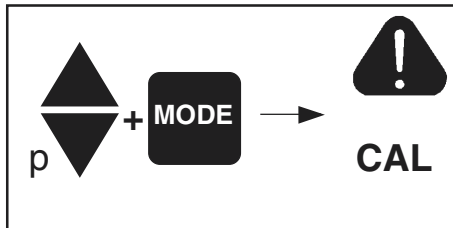

Ventilate the controller and/or the vacuum system. Make sure that the vacuum connection at the controller is at atmospheric pressure.

- ➔ Press key p▲ or p▼ simultaneous with key MODE, the controller then switches to the adjustment mode.
- ☞ The warning triangle and CAL are displayed for approx. 2 seconds.
- ➔ During CAL is displayed, press key START/STOP.
- ➔ Use key p▲ or p▼ to adjust the reading to actual atmospheric pressure.
- ➔ Press key STOP to confirm.

**Note:** To determine the actual atmospheric pressure, use an accurate barometer or get accurate reading from the weather service, the next airport.....(take into account the difference in altitude between e. g. airport and laboratory).

## Adjustment under vacuum

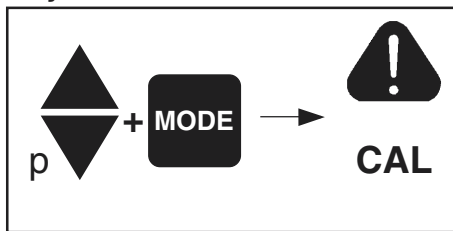

Evacuate the controller to a pressure < 0.5 mbar (e. g. by applying a good rotary vane pump).

- ➔ Press key p▲ or p▼ simultaneous with key MODE, the controller then switches to the adjustment mode.
- ☞ The warning triangle and CAL are displayed for approx. 2 seconds.
- ➔ During CAL is displayed, press key START/STOP.
- ☞ The reading is automatically adjusted to "zero".
- ➔ Press key STOP to confirm.

**Note:** Adjustment under vacuum with an actual pressure higher than 0.5 mbar reduces the accuracy of the measurement. If the pressure is significantly higher than 0.5 mbar, adjustment to a reference pressure is recommended.

## Adjustment at a reference pressure

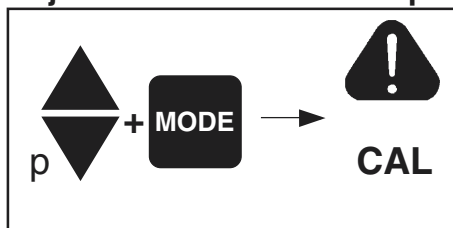

Instead of adjustment under vacuum to a pressure < 0.5 mbar, adjustment to a reference pressure within the range of 0 ..... 20 mbar is possible.

- ➔ Press key p▲ or p▼ simultaneous with key MODE, the controller then switches to the adjustment mode.
- ☞ The warning triangle and CAL are displayed for approx. 2 seconds.
- ➔ During CAL is displayed, press key START/STOP.
- ☞ The reading is automatically adjusted to "zero".
- ➔ Use keys p▲ or p▼ to adjust the display to the reference pressure at the vacuum line within the range of 0 ..... 20 mbar.
- ➔ Press key STOP to confirm.

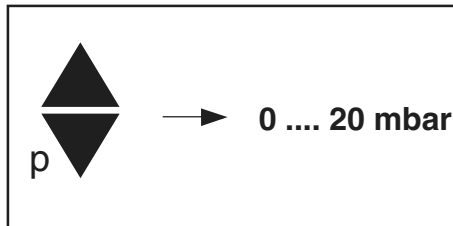

**Note:** The accuracy of the value of the reference pressure will directly affect the accuracy of the adjustment. If the nominal ultimate vacuum of a diaphragm pump is used as reference vacuum, the accuracy of the controller might be doubtful. The diaphragm pump may not achieve the specified value (due to condensate, poor state, failure of valves or the diaphragm).

# How to determine the best distillation conditions

Determine the temperature of the available coolant.

- ☞ In most cases the coolant temperature is given (e. g. tap water, in house cooling water circuit). For maximum solvent recovery, carefully choose the boiling point of the product (by choosing the vacuum level) and the bath temperature accordingly.
- ☞ Determine the lowest boiling point of the product (solvent).
- ☞ The temperature difference between boiling point of the product and the coolant should be more than 20°C, otherwise low vacuum level will lead to significant loss of solvent.
- ☞ Select a water bath temperature of 20-30°C above the boiling point of the product to provide sufficient heat transfer.

Determine the temperature of the bath.

- ☞ If there is no limitation from the product side, a water bath temperature of 60-70°C is usually recommended (efficient heating with minimum generation of water vapour from the bath).

Example: Vacuum selection for a boiling temperature of 40°C (e. g. ethanol):

- ☞ The cooling temperature assumed to be 15-20°C.
- ☞ Water bath temperature 40°C. Wait until temperature is reached.
- ☞ Determine the vacuum level (for ethanol: 170 mbar) for a boiling point (use published data of solvents). Reduce pressure until a sufficient level of evaporation is attained or use the mode "AUTO" of the controller (distillation fully automatically).

## List of solvents

Solvent	Boiling point (°C) at 1013 mbar	Vacuum for boiling point (mbar) (abs.) at T <sub>s</sub> =40°C	Solvent	Boiling point (°C) at 1013 mbar	Vacuum for boiling point (mbar) (abs.) at T <sub>s</sub> =40°C
Acetone	56	556	Ethyl acetate	77	240
Acetonitrile	82	230	Ethylene-dichloride	83	210
Benzene	80	236	Hexane	69	335
t-Butanol	82	130	Methanol	64	337
1-Butanol	118	25	Pentane	36	> 1000
Chloroform	62	474	Isopropanol	82	137
Cyclohexane	81	235	Pyridine	115	60
Dichloromethane	40	1000	Tetrachloro-methane	77	271
Diethyl ether	35	> 1000	Tetrahydrofurane	66	357
Diisopropyl ether	68	375	Toluene	111	77
Dimethyl-formamide	153	11	Trichloroethylene	87	183
1,4-Dioxane	101	107	Xylene	138	25
Ethanol	78	175	Water	100	72

# Interface parameters

The controller CVC 2000 is equipped with a serial interface at the rear side of the housing (RS 232C, nine-pole Sub-D-plug).

- ☞ Respectively plug-into or remove the cable (zero modem cable) from the interface only if the equipment is switched off.
- ☞ The interface is not electrically isolated from the measuring circuit.
- ☞ For optimal electromagnetic compatibility assemble an interface filter (cat. no.: 63 82 35).

The controller can be operated via serial interface. Measuring results, preselections and the status of the controller can be read at any time. Controlling via interface is only possible, if the remote operation mode has been preselected at the controller. **During remote operation ("PC" is displayed) the controller can be operated only via interface, the keys at the controller have no function, the warning triangle is displayed.**

## Setting of the interface

Setting of the interface parameters directly at the controller is described below. The factory set values are underlined.

- ➔ 1200, 2400, 4800 or 9600 BAUD
- ➔ 7 data bits odd, 7 data bits even, 8 data bits none, 8 data bits odd, 8 data bits even
- ➔ no Handshake, XON/XOFF Handshake, CTS/RTS Handshake
- ➔ remote on, remote off
- ☞ Unchangeable: Startbit = 1, Stopbit = 1

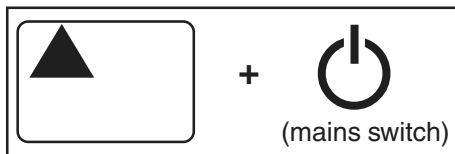

Press key Mode ▲ during switching on.

- ☞ The controller switches to the mode to configurate the interface.

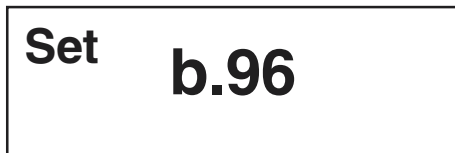

BAUD-Rate is displayed.

- ➔ Press key Mode ▲ or ▼ to select the BAUD rate and confirm with key STOP ("96"=9600, "48"=4800, "24"=2400, "12"=1200).



Data bits are displayed.

- ➔ Press key Mode ▲ or ▼ to select the data bits and confirm with key STOP.



Parity is displayed.

- ➔ Press key Mode ▲ or ▼ to select parity and confirm with key STOP ("no" = no check of parity, "O" = odd, "E" = even).



Handshake is displayed.

- ➔ Press key Mode ▲ or ▼ to select handshake and confirm with key STOP ("no" = no Handshake, "HA" = RTS/CTS, "SO" = XON/XOFF).



Remote is displayed.

- ➔ Press key Mode ▲ or ▼ to select parity and confirm with key STOP ("no" = local operation, "On" = remote operation).

- ☞ The controller switches to normal operation mode (process control not active).

# Read commands

Function	Command	Response	Description
actual pressure	IN_PV_1	XXXX mbar or XXXX Torr or XXXX hPa	unit according to preselections
actual frequency	IN_PV_2	XX.X Hz	
device set preselections	IN_CFG	XXXXX	<ul style="list-style-type: none"> <li>0: remote operation off</li> <li>1: remote operation on</li> <li>0: no automatic switch off</li> <li>1: automatic switch off</li> <li>0: no air admittance valve</li> <li>1: air admittance valve</li> <li>0: no cooling water valve</li> <li>1: cooling water valve</li> <li>0: VACUU•LAN</li> <li>1: continuous pumping</li> <li>2: pressure control without automatic</li> <li>3: pressure control with automatic</li> </ul>
malfunction	IN_ERR	XXXX	<ul style="list-style-type: none"> <li>1: last command to interface incorrect</li> <li>1: malfunction pressure transducer</li> <li>1: overpressure</li> <li>1: fault pump electronics</li> </ul>
status of process control	IN_STAT	XXXX	<ul style="list-style-type: none"> <li>00: VACUU•LAN: inactive</li> <li>01: pumping down, actual pressure &gt; selected pressure</li> <li>02: pumping down, time for automatic switching off is running</li> <li>03: system is switched off</li> <li>10: continuous pumping: inactive</li> <li>11: active</li> <li>20: pressure control: inactive</li> <li>21: actual pressure &gt; selected pressure</li> <li>22: actual pressure = selected pressure (+/- 1mbar)</li> <li>23: actual pressure &lt; selected pressure</li> <li>30: automatic: inactive</li> <li>31: determining boiling point</li> <li>32: adjusting boiling point</li> <li>33: system is switched off</li> <li>0: air admittance valve not driven (closed)</li> <li>1: air admittance valve driven (open)</li> <li>0: cooling water valve not driven (closed)</li> <li>1: cooling water valve driven (open)</li> </ul>

# Write commands

Function	Command	Parameter	Description
selected pressure	OUT_SP_1	XXXX	unit according to preselection (0001 to 1060 mbar (hPa) or 0001 to 0795 Torr)
selected pressure with venting*	OUT_SP_V	XXXX	unit according to preselection (0001 to 1060 mbar (hPa) or 0001 to 0795 Torr)
selected frequency	OUT_SP_2	XX.X	Hz (01.0 to 60.0 in steps of 0.5 Hz or 99.9 for "HI")
pressure for restart (VACUU•LAN)	OUT_SP_3	XXXX	unit according to preselection (see OUT_SP_1)
time for automatic switching off (VACUU•LAN)	OUT_SP_4	XX:XX	hours:minutes
automatic switching off (pressure control)	OUT_SP_5	XXXX	unit according to preselection (see OUT_SP_1) or "0000" for automatic switching off ("AE")
operation mode	OUT_MODE	X	1: continuous pumping 2: pressure control without automatic 3: pressure control with automatic
driving air admittance valve	OUT_VENT	X	0: air admittance valve close (not automatically) 1: air admittance valve open (process control stopped)
starting process control	START		
stopping process control	STOP	X	1: termination of process control 2: termination of process control and storage of the actual pressure as new set point

\* Pressure setting with venting is only possible in operation mode "Pressure control" if an air admittance valve is connected and configured and pressure control is started. The air admittance valve opens automatically if the actual pressure is 10 mbar below the preset pressure. Automatic venting becomes inactive if pressure control is stopped (STOP or VENT), setting a pressure value using the command OUT\_SP\_1 or if the operation mode is changed. Activate the command OUT\_SP\_V again if necessary.

The single abbreviations of a command are separated by underscores (ASCII 5FH).

Command and parameter are separated by ignore characters (ASCII 20H).

The string is terminated with <CR><LF> (ASCII 0DH, ASCII 0AH).

Set the values with leading zeros if necessary.

## Connector assignment

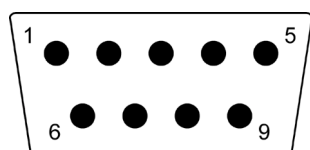

- 2: RxD
- 3: TxD
- 4: DTR
- 5: Mass
- 7: RTS
- 8: CTS

# Replacing diaphragms and valves



All bearings are encapsulated and are filled with long-life lubricant. Under normal operating conditions, the pump is maintenance free. The valves and the diaphragms are wear parts. If the rated ultimate vacuum is no longer achieved, the pump interior, the diaphragms and the valves must be cleaned and the diaphragms and valves must be checked for cracks or other damage.

Depending on individual cases it may be efficient to check and clean the pump heads on a regular basis. In case of normal wear the lifetime of the diaphragms and valves is > 10000 operating hours.

☞ Prevent internal condensation, transfer of liquids or dust. The diaphragm and valves will be damaged, if liquids are pumped in significant amount.

If the pump is exposed to corrosive gases or vapour or in case of deposits, maintenance should be carried out frequently.

☞ Regular maintenance will improve the lifetime of the pump and also protect both personnel and environment.

**Before starting maintenance** vent the system, isolate the pump and other components from the vacuum system and the electrical supply. **Wait two minutes** after isolating the equipment from mains to allow the capacitors to discharge. Drain condensate if applicable, avoid the release of pollutants. Allow sufficient cooling of the pump.

**Ensure that the pump cannot be operated accidentally. Never operate the pump if covers or other parts of the pump are disassembled. Never operate a defective or damaged pump.**

Ensure that the maintenance technician is familiar with the safety procedures which relate to the products processed by the pumping system.

**Attention:** The pump might be contaminated with the process chemicals that have been pumped during operation. Ensure that the pump is decontaminated before maintenance and take adequate precautions to protect people from the effects of dangerous substances if contamination has occurred.

☞ Wear appropriate safety-clothing when coming in contact with contaminated components.



**Set of seals MD 1C** (4 diaphragms, 8 valves, diaphragm key) ..... cat. no. **69 68 28**



## Tools:

- diaphragm key SW 46
- open ended wrench SW 15 / 17
- hex key SW 4/5
- Phillips screw driver Gr. 2

☞ **Please read section "Replacing diaphragms and valves" completely before starting maintenance.**

Partially the pictures show pumps in other versions. This doesn't influence replacing diaphragms and valves of the pump.

## Cleaning and inspecting the pump heads:

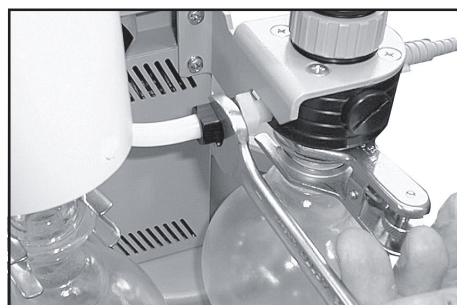

Use open-ended wrench to remove union nut at the inlet of the pump.

Remove hose from the fitting.

Do not remove the elbow fitting from the pump head.

☞ Through reassembly a leak may result.

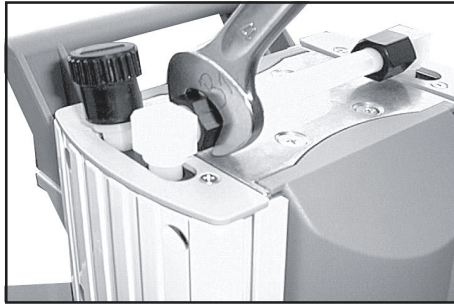

Use open-ended wrench to remove union nut at hose connection next to the gas ballast.

Use open ended wrench (w/f 15) to turn elbow fitting 1/4 of a turn, reconnect hose. Do not remove the elbow fitting from the pump head.

- ⚠ Through reassembly a leak may result.

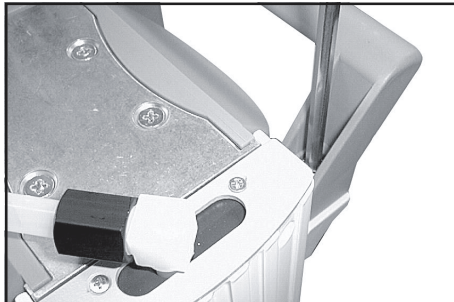

Use Phillips screw driver to unscrew the handle at one side of the housing cover.

It is not necessary to disassemble the exhaust waste vapour condenser.



Use hex key to remove six socket head screws from pump head and remove upper housing (housing cover, housing cover insert and head cover).

- ⚠ Never remove parts by using a spiky or sharp-edged tool (e. g. screw driver), we recommend to use a rubber mallet or compressed air (to be blown carefully into port).

Remove head cover from housing cover and check valves. Note position of valves and remove.

- ⚠ Replace valves if necessary.

Use petroleum ether or industrial solvent to remove deposits. Do not inhale.

Check diaphragm for damage and replace if necessary.

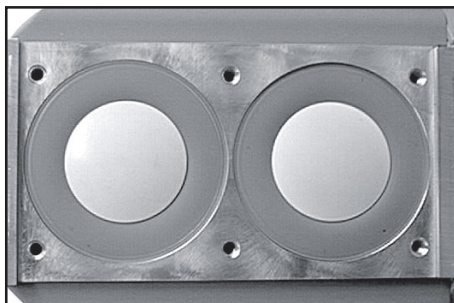

### Replacing the diaphragm:



Lift diaphragm carefully.

- ⚠ Apply pressure to the clamping disc beside the diaphragm to bring connecting rod into upper turning point position if necessary.

- ⚠ Never use a spiky or sharp-edged tool to lift the diaphragm. Use diaphragm key to grip under the diaphragm to the diaphragm support disc.

Apply pressure to the diaphragm clamping disc to bring the diaphragm into lower turning point position. Press diaphragm key against diaphragm clamping disc and remove diaphragm support disc with diaphragm.

- ⚠ If the old diaphragm is difficult to separate from the support disc, immerse assembly in naphtha or petroleum ether. Do not inhale!

- ⚠ Check for washers under clamping disc. Do not mix the washers from the different heads. Make sure that the original number is reassembled at the individual pump head.

## View of the disassembled pump head parts

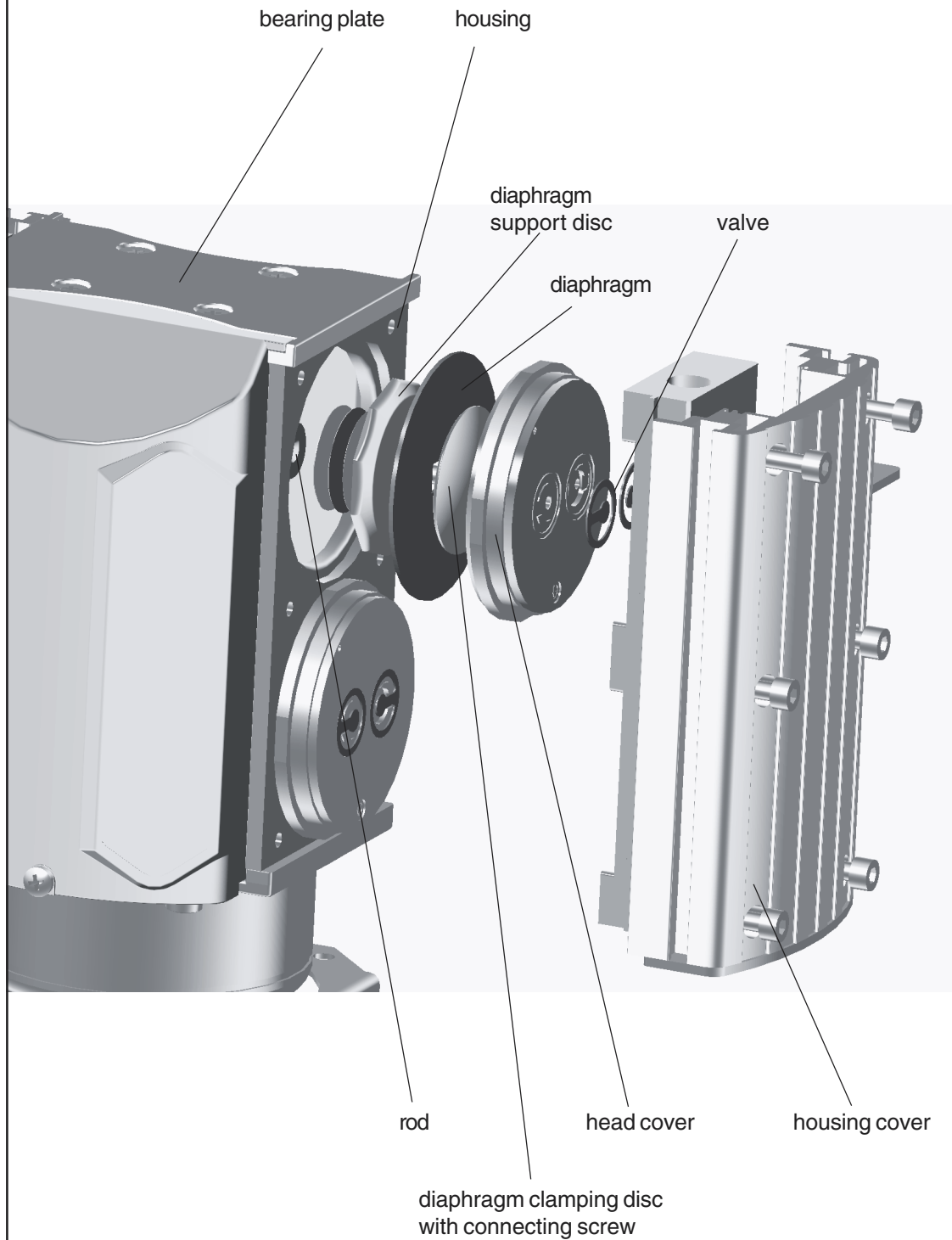





Position new diaphragm between diaphragm clamping disc with square head screw and diaphragm support disc.

- ☞ **Note:** Position diaphragm with white PTFE side to diaphragm clamping disc (to pump chamber).

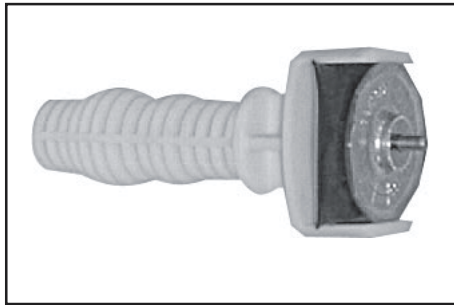

Lift diaphragm at the side and position carefully together with diaphragm clamping disc and diaphragm support disc in the diaphragm key.

- ☞ Avoid damage of the diaphragm: Do not crack diaphragm in a way that light lines occur on the upper side of the diaphragm.

Check for washers under clamping disc. Do not mix the washers from the different heads. Make sure that the original number is reassembled at the individual pump head.

- ☞ Smaller number of washers: The pump will not attain final vacuum. More washers: Clamping disc will hit head cover; noise or even blockage of the pump.

### Assembling pump heads:



- ☞ Make sure that the square head screw of the diaphragm clamping disc is correctly seated in the guide hole of the diaphragm support disc.

Assemble diaphragm clamping disc, diaphragm and diaphragm support disc to connecting rod.

- ☞ Position washers if available between diaphragm support disc and rod.

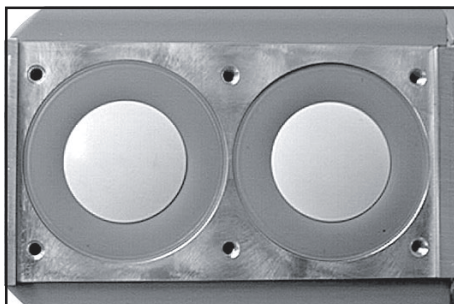

Bring diaphragm into a position in which diaphragm is in contact with housing and centred with respect to bore.

Position pumping unit on the side and support appropriately.

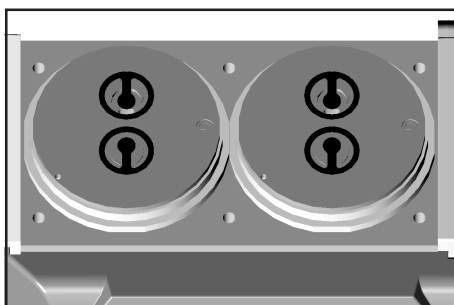

Assemble head covers and valves.

- ☞ Check for correct position (see fig. below).

**Obey position and orientation of the head covers and the valves definitely.**

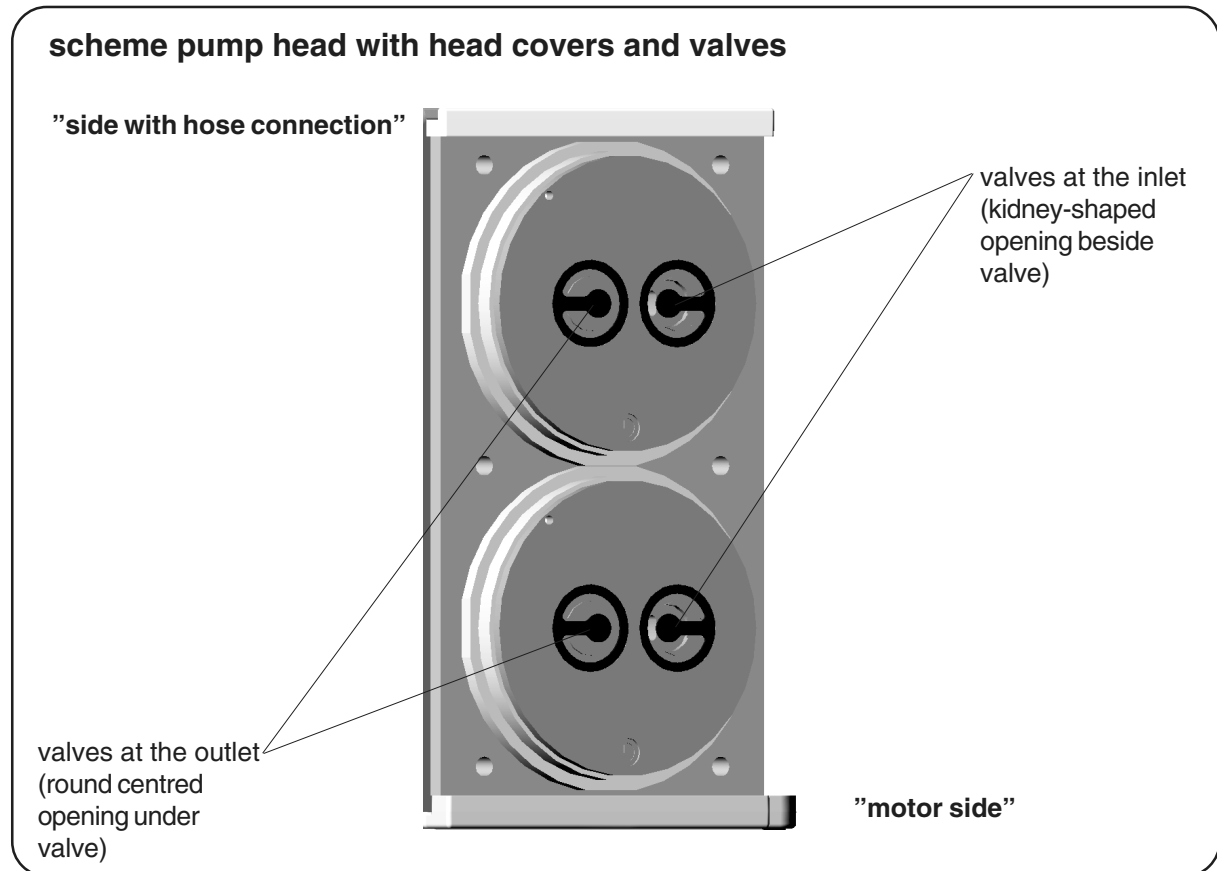

**Position housing cover.**

- ☞ Move housing cover slightly to make sure that the head covers are correctly positioned.
- ☞ Screw in six socket head screws fixing housing cover cross-wise first slightly, then tighten.
- ☞ Do not tighten until head cover is in contact with housing, **max. torque 6 Nm.**
- ☞ Inspect the other pump heads (side of the exhaust waste vapour condenser) the same way.

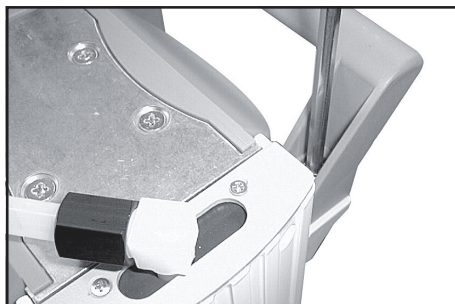

**Assemble the handle.**

## Assembling of fittings:

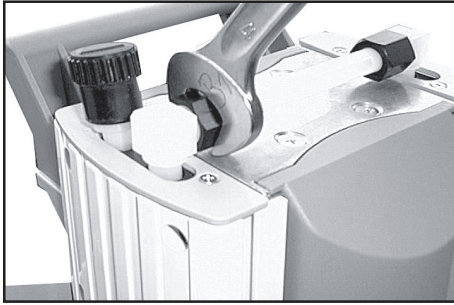

Use open ended wrench to reconnect hose to elbow fitting.  
Tighten union nuts first by hand and then tighten one full turn using open ended wrench.

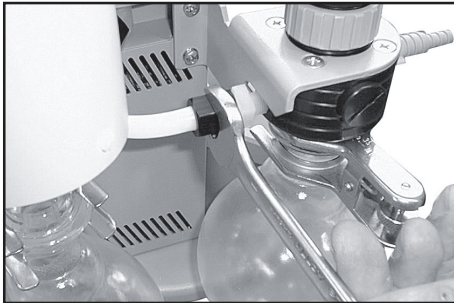

Connect hose to fitting.  
Tighten union nuts first by hand and then tighten one full turn using open ended wrench.



### **If the pump does not achieve the ultimate pressure:**

☞ In case the diaphragms and valves have been replaced, a run-in period of several hours is required before the pump achieves its ultimate vacuum.

If all pump heads achieve a vacuum below 90 mbar but pump does not achieve the ultimate total pressure:

Check hose connectors between pump heads and manifolds for leaks. If necessary recheck pump chamber.

# Cleaning and assembling components

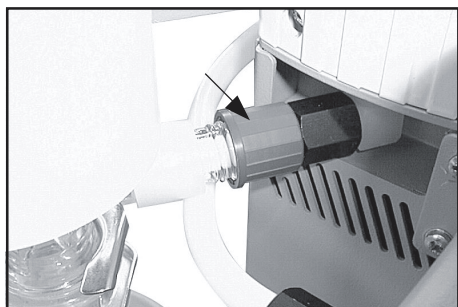

**Overpressure safety relief device** ..... 63 88 21  
(at the exhaust waste vapour condenser)

- ☞ Remove union nut at the condenser and remove hose from the inlet of the condenser.



- ☞ Unscrew the exhaust waste vapour condenser from the pumping unit.

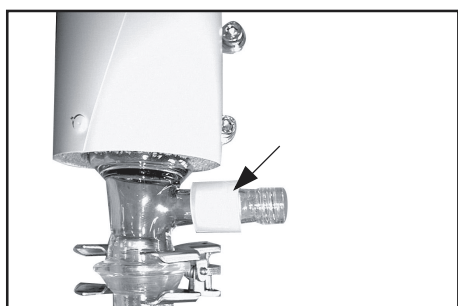

- ☞ Pull off old overpressure safety relief device and install new one. Check for correct position of the PTFE-foil under the overpressure safety relief device.

- ☞ Assemble exhaust waste vapour condenser to the pumping unit.



**Seal ring 19 x 24.4** ..... 63 79 83  
(FPM, e. g. Viton®) at the pressure transducer

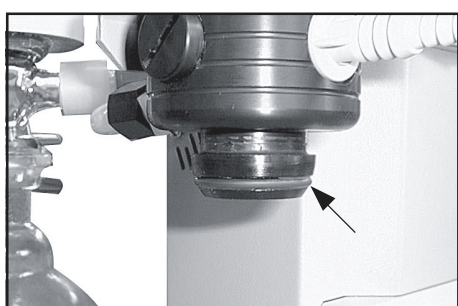

**Round bottom flask 500 ml, coated** ..... 63 84 97

**O-ring 28 x 2,5** ..... 3 12 05 53  
(FPM, e. g. Viton®) at the spherical ground joint of the round bottom flask at the inlet

## Cleaning the gauge head VSK 5

The gauge itself is maintenance-free.

If the vacuum system is contaminated (oil, particles, etc.), contamination of the pressure transducer will influence the accuracy of measurement.

- ➔ Fill the gauge head chamber with a solvent (e. g. benzene) and allow sufficient cleaning time. Observe all regulations concerning usage and disposal of solvents!
- ➔ Drain the solvent and dispose of in accordance with regulations, repeat cleaning if necessary.
- ➔ Rinse the gauge head chamber several times with alcohol in order to remove all solvent residues.
- ⚠ Never use a spiky or sharp-edged tool to clean the pressure transducer.
- ➔ Allow the pressure transducer to dry.
- ➔ Readjust the pressure transducer if necessary.

## Calibration in the factory

### Control of measuring equipment

The **VACUUBRAND DKD calibration laboratory** is accredited by the Physikalisch-Technische Bundesanstalt (PTB; German national institute for science and technology and the highest technical authority of the Federal Republic of Germany for the field of meteorology and certain sectors of safety engineering) for the measurable variable **pressure in the pressure range from  $10^{-3}$  mbar to 1000 mbar** in accordance with the general criteria for the operation of testing laboratories defined in the EN 45000 series of standards. Calibration in the VACUUBRAND calibration laboratory:

- To meet the requirements of the DIN ISO 9000ff and 10012 series of standards regarding the calibration of inspection, measuring and test equipment at specified intervals.
- To document that the vacuum gauges calibrated are traceable to national standards of the PTB.

# Notes on return to the factory

## Repair - return - DKD calibration



Safety and health of our staff, laws and regulations regarding the handling of dangerous goods, occupational health and safety regulations and regulations regarding safe disposal of waste require that for all pumps and other products the “**Health and safety clearance form**“ must be send to our office duly completed and signed before any equipment is dispatched to our premises.

Fax or post a completed copy of the health and safety clearance form to us in advance. The declaration must arrive before the equipment. Enclose a second completed copy with the product. If the equipment is contaminated you must notify the carrier.



**No repair / DKD calibration is possible unless the correctly completed form is returned. Inevitably, there will be a delay in processing the equipment if information is missing or if this procedure is not obeyed.**

If the product has come in contact with chemicals, radioactive substances or other substances dangerous to health or environment, the product must be decontaminated prior to **sending it back to the factory.**

☞ Return the product to us **disassembled and cleaned** and accompanied by a certificate verifying decontamination or

☞ Contact an industrial cleaning and **decontamination service** directly or

☞ Authorize us to send the product to an industrial cleaning facility **at your expense.**

To expedite repair and to reduce costs, please enclose a detailed description of the problem and the product’s operating conditions with every product returned for repair.

We submit **quotations** only on request and always at the customer’s expense. If an order is given, the costs incurred are offset from the costs for repair or from the purchase price, if the customer prefers to buy a new product instead of repairing the defective one.



☞ **If you do not wish a repair on the basis of our quotation, the equipment might be returned to you disassembled and at your charge!**

In many cases, the **components must be cleaned in the factory** prior to repair.

For cleaning we use an environmentally responsible water based process. Unfortunately the combined attack of elevated temperature, cleaning agent, ultrasonic treatment and mechanical stress (from pressurised water) may result in damage to the paint. Please mark in the health and safety clearance form if you wish a **repaint at your expense** just in case such a damage should occur.

We also replace parts due to optical aspects upon your request.

**Before returning** the equipment ensure that (if applicable):

☞ Oil has been drained and an adequate quantity of fresh oil has been filled in to protect against corrosion.

☞ Equipment has been cleaned and/or decontaminated.

☞ All inlet and outlet ports have been sealed.

☞ Equipment has been properly packed, if necessary, please order an original packaging (costs will be charged), marked as appropriate and the carrier has been notified.

☞ Ensure that the completed health and safety declaration is enclosed.



We hope for your understanding for these measures, which are beyond our control.



### **Scrapping and waste disposal:**

Dispose of the equipment and any components removed from it safely in accordance with all local and national safety and environmental requirements. Particular care must be taken with components and waste oil which have been contaminated with dangerous substances from the process. Do not incinerate fluoroelastomer seals and “O” rings.

☞ You may authorize us to dispose of the equipment **at your expense.**

# Health and safety clearance form

## Declaration concerning safety, potential hazards and safe disposal of waste, e. g. used oil.

Safety and health of our staff, laws and regulations regarding the handling of dangerous goods, occupational health and safety regulations, safety at work laws and regulations regarding safe disposal of waste, e. g. waste oil, require that for all pumps and other products this form must be sent to our office duly completed and signed before any equipment is dispatched to our premises. **Products will not be accepted for any procedure and handling and repair / DKD calibration will not start before we have received this declaration.**

- a) Fax or post a **completed copy of this form** to us in advance. The declaration must arrive before the equipment. **Enclose a second, completed copy with the product.** If the product is contaminated you must notify the carrier (**GGVE, GGVS, RID, ADR**).
- b) Inevitably, the repair process will be delayed considerably, if this information is missing or this procedure is not obeyed. We hope for your understanding for these measures which are beyond our control and that you will assist us in expediting the repair procedure.
- c) **Make sure that you know all about the substances which have been in contact with the equipment and that all questions have been answered correctly and in detail.**

<p><b>1. Product (Model):</b> .....</p> <p><b>2. Serial No.:</b> .....</p> <p><b>3. List of substances in contact with the equipment or reaction products:</b></p> <p><b>3.1 Chemical/substance name, chemical symbol:</b></p> <p>a) .....</p> <p>b) .....</p> <p>c) .....</p> <p>d) .....</p> <p><b>3.2 Important informations and precautions, e. g. danger classification:</b></p> <p>a) .....</p> <p>b) .....</p> <p>c) .....</p> <p>d) .....</p> <p><b>4. Declaration (please mark as applicable):</b></p> <p><input type="checkbox"/> <b>4.1 for non dangerous goods:</b></p> <p>We assure for the returned product that</p> <ul style="list-style-type: none"> <li>- neither toxic, corrosive, biologically active, explosive, radioactive nor contamination dangerous in any way has occurred.</li> <li>- the product is free of dangerous substances.</li> <li>- the oil or residues of pumped media have been drained.</li> </ul> <p><input type="checkbox"/> <b>4.2 for dangerous goods:</b></p> <p>We assure for the returned product that</p> <ul style="list-style-type: none"> <li>- all substances, toxic, corrosive, biologically active, explosive, radioactive or dangerous in any way which have pumped or been in contact with the product are listed in 3.1, that the information is complete and that we have not withheld any information.</li> <li>- the product, in accordance with regulations, has been             <ul style="list-style-type: none"> <li><input type="checkbox"/> cleaned</li> <li><input type="checkbox"/> decontaminated</li> <li><input type="checkbox"/> sterilized.</li> </ul> </li> </ul>	<p><b>5. Way of transport / carrier:</b></p> <p>.....</p> <p>Day of dispatch to VACUUBRAND:</p> <p>.....</p> <p><b>If the paint is damaged, we wish a repaint or a replacement of parts due to optical aspects at our expense (see "Notes on return to the factory"):</b></p> <p><input type="checkbox"/> yes <span style="margin-left: 150px;"><input type="checkbox"/> no</span></p> <p><b>We declare that the following measures - where applicable - have been taken:</b></p> <ul style="list-style-type: none"> <li>- The oil has been drained from the product.</li> <li><b>Important: Dispose of according to national regulations.</b></li> <li>- The interior of the product has been cleaned.</li> <li>- All inlet and outlet ports of the product have been sealed.</li> <li>- The product has been properly packed, if necessary, please order an original packaging (costs will be charged) and marked as appropriate.</li> <li>- The carrier has been informed about the hazardous nature of the goods (if applicable).</li> </ul> <p><b>We assure VACUUBRAND</b> that we accept liability for any damage caused by providing incomplete or incorrect information and that we shall indemnify VACUUBRAND from any claims as regards damages from third parties.</p> <p><b>We are aware</b> that as expressed in § 823 BGB (Public Law Code of Germany) we are directly liable for injuries or damages suffered by third parties, particularly VACUUBRAND employees occupied with handling/repairing the product.</p> <p>Signature: .....</p> <p>Name (print): .....</p> <p>Job title (print): .....</p> <p>Company's seal: .....</p> <p>Date: .....</p>
---	---

**VACUUBRAND GMBH + CO KG**  
 -Technology for vacuum systems-  
 © 2001 VACUUBRAND GMBH + CO KG Printed in Germany

D-97866 Wertheim - P. O. Box 1664  
 D-97877 Wertheim - Alfred-Zippe-Str. 4  
 Tel. (+49)9342 / 808-0 - Fax: (+49)9342 / 59880



Disclaimer: Our technical literature is only intended to inform our customer. The validity of general empirical values and results obtained under test conditions for specific applications depend on a number of factors beyond our control. It is therefore strictly the users' responsibility to very carefully check the validity of application to their specific requirements. No claims arising from the information provided in this literature will, consequently, be entertained.

**VACUUBRAND GMBH + CO KG**  
-Technology for Vacuum Systems-

© 2003 VACUUBRAND GMBH + CO KG Printed in Germany 99 91 00

D-97866 Wertheim - P. O. Box 1664

D-97877 Wertheim - Alfred-Zippe-Str. 4

Tel. (++49)9342 / 808-0 - Fax (++49)9342 / 59880

*vacuubrand*