



Instruction Manual
Thermal Shake Touch
Cooling Thermal Shake Touch



TABLE OF CONTENTS

Package Contents	1
Warranty	1
Installation	1
Maintenance & Servicing	2
Intended Use	2
Equipment Disposal	2
Environmental Conditions	2
Safety Instructions	3-4
Standards & Regulations	3-4
Control Panel	5
Icon Legend	6
Specifications	7-8
Installing a Block	9
Operating Instructions	10-14
Technical Service	14
Troubleshooting	15-17
Replacement Parts	18-19
Accessories	20

PACKAGE CONTENTS

Thermal Shake Touch with 1.5mL Block, Rack and Cover or
Cooling Thermal Shake Touch with 1.5mL Block, Rack and Cover
Hex Head Screwdriver
92" (234cm) Detachable Power Cord
Instruction Manual

WARRANTY

Manufacturer warrants this product to be free from defects in material and workmanship when used under normal conditions for five (5) years. Register your equipment or instrument online at www.vwrsp.com/warranty for US residents or www.vwrcanlab.com/warranty for Canadian residents. For your reference, make a note of the serial number, date of purchase and supplier here.

Serial Number: _____

Date of Purchase: _____

Supplier: _____

INSTALLATION

Upon receiving the VWR Thermal Shake Touch or VWR Cooling Thermal Shake Touch check to ensure that no damage has occurred in shipment. It is important that any damage that occurred in transport is detected at the time of unpacking. If you do find such damage the carrier must be notified immediately.

After opening the carton, use the included hex head screwdriver to remove the two hex head screws and washers that secure the shipping plate. **Do Not Remove** the unit from the carton until the shipping plate is taken off. Always lift the unit by the sides of the housing to prevent damage to the unit.

After unpacking, remove the protective coverings from the feet and place the Thermal Shake Touch or Cooling Thermal Shake Touch on a level bench or table, away from explosive vapors.

Ensure that the surface on which the unit is placed is clean and free of dust.

Always place the unit on a sturdy work surface.

To ensure proper function and air flow, position the unit at least 6" away from adjacent devices and walls.

Position the unit in such a way that it is easy to reach and unplug the power cord from the back of the unit.

Ensure that the surface on which the unit is placed will withstand typical heat produced by the unit. Always place the unit on a sturdy work surface.

The Thermal Shake Touch or Cooling Thermal Shake Touch is supplied with a power cord that is inserted into the IEC connector on the back of the unit first, then it can be plugged into a properly grounded outlet. The 120V unit plugs into a 120 volt, 50/60 Hz source. The 230V unit plugs into a 230 volt, 50/60 Hz source. DO NOT replace the cord with an inadequately rated main supply cord.

MAINTENANCE & SERVICING

The Thermal Shake Touch and Cooling Thermal Shake Touch are built for long, trouble-free, dependable service. No lubrication or other technical user maintenance is required. It needs no user maintenance beyond keeping the surfaces clean.

The unit should be given the care normally required for any electrical appliance. Avoid wetting or unnecessary exposure to fumes. Spills should be removed promptly. DO NOT use a cleaning agent or solvent on the front panel or touch screen which is abrasive or harmful to plastics, nor one which is flammable. Always ensure the power is disconnected from the unit prior to any cleaning. If the unit ever requires service, contact your VWR representative.

INTENDED USE

The VWR Thermal Shake Touch and Cooling Thermal Shake Touch are intended for general laboratory use.

ENVIRONMENTAL CONDITIONS

Operating Conditions: Indoor use only.

Temperature:	5 to 40°C (41 to 104°F)
Humidity:	maximum 80% relative humidity, non-condensing
Altitude:	0 to 6562 feet (2000 M) above sea level

Non-Operating Storage:

Temperature:	-20 to 65°C (-4 to 149°F)
Humidity:	maximum 80% relative humidity, non-condensing

Installation Category II and Pollution Degree 2 in accordance with IEC 664.

SAFETY INSTRUCTIONS

Please read the entire instruction manual before operating the VWR Thermal Shake Touch or Cooling Thermal Shake Touch.



WARNING! DO NOT use the VWR Thermal Shake Touch or Cooling Thermal Shake Touch in a hazardous atmosphere or with hazardous materials for which the unit was not designed. Also, the user should be aware that the protection provided by the equipment may be impaired if used with accessories not provided or recommended by the manufacturer, or used in a manner not specified by the manufacturer.

Always lift unit by the housing, **never** by the block. Always operate unit on a level surface for best performance and maximum safety.



CAUTION! To avoid electrical shock, completely cut off power to the unit by disconnecting the power cord from the unit or unplugging from the wall outlet. Disconnect unit from the power supply prior to maintenance and servicing.

Spills should be removed promptly. **DO NOT** immerse the unit for cleaning. **DO NOT** operate the unit if it shows signs of electrical or mechanical damage.



CAUTION! The caution hot indicator light warns that the temperature of the top plate is above 40°C. The light will illuminate and remain lit when the temperature of the top plate reaches approximately 40°C. When the heat is turned off, the caution hot indicator light will stay lit until the temperature of the top plate is less than 40°C.



Pinch Point - Keep fingers clear during operation



Earth Ground - Protective Conductor Terminal



Alternating Current

STANDARDS & REGULATIONS

Trombner, LLC hereby declares under its sole responsibility that the construction of this product conforms in accordance with the following standards:

Associated EU directives:

EMC directive	2004/108/EC
LVD directive	2006/95/EC
RoHS directive	2011/65/EU

Safety standards:

CAN/CSA C22.2 No. 61010-1:2012-05
UL 61010-1:2012-05
EN 61010-1:2010-10

Safety requirements for electrical equipment for measurement, control and laboratory use. Part: General Requirements.

CAN/CSA C22.2 No. 61010-2-010:2015-07
EN 61010-2-010:2014-11

Part II: Particular requirements for laboratory equipment for the heating of materials.

CAN/CSA C22.2 No. 61010-2-051:2015-10
EN 61010-2-051:2015-04

Part II: Particular requirements for laboratory equipment for mixing and stirring

EMC standards:

EN61326-1 Class A	EN61000-3-3/3-2
EN6100-4-5	EN61000-4-4
EN55022-B	EN61000-4-3
EN61000-4-11	EN61000-4-6

This device complies with Part 15 of the FCC Rules. Operation is subject to the following two conditions: (1) this device may not cause harmful interference, and (2) this device must accept any interference received, including interference that may cause undesired operation.

This Class A digital apparatus complies with Canadian ICES-003.

CONSIGNES DE SÉCURITÉ

Veillez lire attentivement le mode d'emploi de l'appareil avant d'utiliser l'agitateur chauffant VWR à écran tactile ou l'agitateur chauffant et réfrigérant VWR à écran tactile.



AVERTISSEMENT ! N'UTILISEZ JAMAIS l'agitateur chauffant VWR à écran tactile ou l'agitateur chauffant et réfrigérant VWR à écran tactile dans une atmosphère dangereuse ni avec aucune matière dangereuse pour laquelle l'unité n'a pas été conçue. L'utilisateur doit également garder à l'esprit que la protection de l'équipement peut être compromise s'il est utilisé avec des accessoires non fournis ni recommandés par le fabricant ou s'il est employé d'une manière non spécifiée par le fabricant.

Soulevez toujours l'unité en l'empoignant par le boîtier, mais **jamais** par le bloc d'agitation. Utilisez toujours l'unité sur une surface plane pour obtenir les meilleures performances avec un maximum de sécurité.



MISE EN GARDE! Pour éviter tout risque de choc électrique, mettez l'unité complètement hors tension en débranchant le cordon d'alimentation de l'unité ou en retirant la fiche de la prise murale. Déconnectez l'unité de l'alimentation électrique avant toute opération de maintenance ou de réparation.

Tout liquide renversé doit être immédiatement essuyé et éliminé. **NE PLONGEZ JAMAIS** l'unité dans un liquide pour procéder à son nettoyage. **N'UTILISEZ JAMAIS** l'unité si elle présente un quelconque endommagement au niveau électrique ou mécanique.



MISE EN GARDE! Le voyant avertisseur de surface chaude s'allumera lorsque la température de la plaque supérieure dépasse les 40 °C. Le voyant s'allume et reste allumé lorsque la température de la plaque supérieure avoisine les 40 °C. Lorsque la source de chaleur est éteinte, le voyant avertisseur de surface chaude reste allumé jusqu'au moment où la température de la plaque supérieure est inférieure à 40 °C.



Point de pincement – Gardez les doigts à l'écart lors de l'utilisation



Prise de terre – Borne du conducteur de protection



Courant alternatif

NORMES ET RÉGLEMENTATIONS

Par la présente, VWR International déclare sur l'honneur que les produits sont conformes aux exigences des directives et des normes suivantes.

Directives UE associées:

Directive CEM	2004/108/CE
Directive BT	2006/95/CE
Directive RoHS	2011/65/EU

Normes de sécurité:

CAN/CSA C22.2 No. 61010-1:2012-05	Règles de sécurité pour appareils électriques de mesurage, de régulation et de laboratoire.
UL 61010-1:2012-05	Partie 1 : Prescriptions générales.
EN 61010-1:2010-10	

CAN/CSA C22.2 No. 61010-2-010:2015-07	Partie 2 : Exigences particulières pour appareils de laboratoire utilisés pour l'échauffement des matières.
EN 61010-2-010:2014-11	

CAN/CSA C22.2 No. 61010-2-051:2015-10	Partie 2 : Prescriptions particulières pour appareils de laboratoire utilisés pour mixer et agiter.
EN 61010-2-051:2015-04	

Normes CEM:

EN61326-1 Class A	EN61000-3-3/3-2
EN6100-4-5	EN61000-4-4
EN55022-B	EN61000-4-3
EN61000-4-11	EN61000-4-6

Cet équipement est conforme à la section 15 de la réglementation de la Commission fédérale des communications des États-Unis (réglementation FCC). Son fonctionnement est soumis aux deux conditions suivantes : (1) cet appareil ne doit pas provoquer d'interférences nuisibles, et (2) cet appareil doit accepter toute autre interférence reçue, y compris les interférences pouvant entraîner un fonctionnement non désiré.

Cet appareil numérique de classe A est conforme à la norme canadienne NMB-003.

CONTROL PANEL

The front panel of the Thermal Shake Touch and Cooling Thermal Shake Touch contains all the controls and displays needed to operate the unit with the touch of a finger.

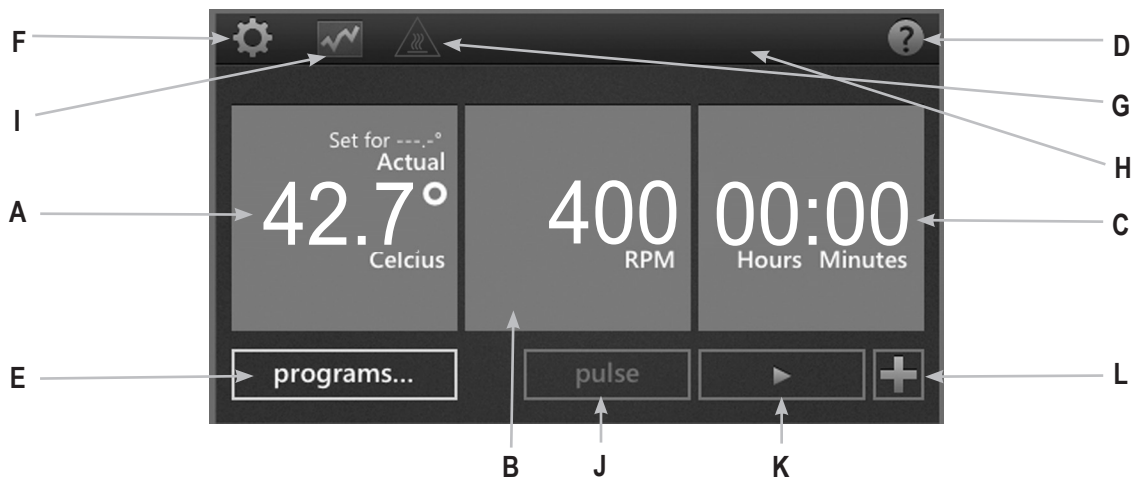

A. Temperature display: Displays the actual and set point temperatures in °C

B. Speed display: Displays the speed in RPM's

C. Time display: Displays elapsed time, or when programmed, counts down and shows remaining time.

D. Help button: Whenever this icon is displayed in the upper right corner, a help screen is available.

E. Program button: Touch to enter Program Mode

F. Settings button: Touch this icon to access and change important settings.

G. Caution hot top: When icon is illuminated, indicates the surface temperature is above 40°C.

H. Block type: Unit indicates the type of block attached to the unit.















I. Chart icon: This icon appears when a program is running and shows program status.

J. Pulse button: Touch to shake, release to stop

K. Start button

L. Add a step button: Add a step to the current settings in order to create a program.

ICON LEGEND

	Power Button		Stop
	Help		Add Steps to a Program
	Settings		Indicates temperature settings in a program
	Chart		Indicates speed settings in a program
	Caution Hot		Back Arrow
	Start		Power Failure
	Pause		Delete

SPECIFICATIONS - THERMAL SHAKE TOUCH



Operating Conditions: Indoor use only.

Temperature:	5 to 40°C (41 to 104°F)
Humidity:	maximum 80% relative humidity, non-condensing
Altitude:	0 to 6562 feet (2000 M) above sea level

Non-Operating Storage:

Temperature:	-20 to 65°C (-4 to 149°F)
Humidity:	maximum 80% relative humidity, non-condensing

Installation Category II and Pollution Degree 2 in accordance with IEC 664.

Overall dimensions (L x W x H):	26 x 24.8 x 13.2cm (10.25 x 9.75 x 5.2")
Electrical (50/60 Hz):	120V, 1.8A, 215W 230V, 0.9A, 210W
Temperature range:	4°C above ambient to 100°C
Temperature accuracy:	+/- 1°C from 20°C to 45°C, +/- 2°C above 45°C
Temperature accuracy, Microplate, 15mL and 50mL Blocks**:	+/- 2°C below 70°C, -5°C above 70°C
Heating rate:	5°C/min
Speed range:	
384 well plate block	1400 rpm
0.2mL PCR plate block	1400 rpm
0.5mL tube block	3000 rpm
1.5mL tube block	2200 rpm
2.0mL tube block	2200 rpm
2.0mL cryo tube block	2200 rpm
12mm tube block	2200 rpm
5mL Eppendorf™ tube block	2200 rpm
15mL conical tube block	800 rpm
50mL conical tube block	800 rpm
Microplate thermal block	2400 rpm
Speed accuracy:	+/- 2%
Orbit:	3mm
Timer:	1 min. to 99 hrs. 59 min.
Unit weight:	9.75lbs (4.4kg)
Ship weight:	11.9lbs (5.4kg)

** Temperature accuracy can be improved by performing a single point calibration

SPECIFICATIONS - COOLING THERMAL SHAKE TOUCH



Operating Conditions: Indoor use only.

Temperature:	5 to 40°C (41 to 104°F)
Humidity:	maximum 80% relative humidity, non-condensing
Altitude:	0 to 6562 feet (2000 M) above sea level

Non-Operating Storage:

Temperature:	-20 to 65°C (-4 to 149°F)
Humidity:	maximum 80% relative humidity, non-condensing

Installation Category II and Pollution Degree 2 in accordance with IEC 664.

Overall dimensions (L x W x H):	26 x 24.8 x 13.2cm (10.25 x 9.75 x 5.2")		
Electrical (50/60 Hz):	120V, 1.8A, 215W 230V, 0.9A, 210W		
Temperature range:	17° below ambient to 100°C		
Temperature accuracy:	+/- 0.5°C from 20°C to 45°C, +/- 2°C below 20°C and above 45°C		
Temperature accuracy, Microplate, 15mL and 50mL Blocks**:	+/- 2°C below 70°C, -5°C above 70°C		
Heating Rate:	5°C/min		
Cooling Rate:	Above ambient 2-3°C/min Below ambient 0.5-1.0°C/min		
Speed range:			
384 well plate block	1400 rpm	2.0mL cryo tube block	2200 rpm
0.2mL PCR plate block	1400 rpm	12mm tube block	2200 rpm
0.2mL PCR plate block	1400 rpm	5mL Eppendorf™ tube block	2200 rpm
0.5mL tube block	3000 rpm	15mL conical tube block	800 rpm
1.5mL tube block	2200 rpm	50mL conical tube block	800 rpm
2.0mL tube block	2200 rpm	Microplate thermal block	2400 rpm
Speed accuracy:	+/- 2%		
Orbit:	3mm		
Timer:	1 min. to 99 hrs. 59 min.		
Unit Weight:	9.75lbs (4.4kg)		
Ship Weight:	11.9lbs (5.4kg)		

** Temperature accuracy can be improved by performing a single point calibration

INSTALLING A BLOCK

1. Looking at the underside of the block, align the hole in the block with the temperature sensor on the top plate and carefully place the block on top of the plate.
2. With the included screwdriver, hand tighten the 2 integrated screws on the block to the top plate to fully install the block. Be sure not to over tighten.
3. The unit will now be able to read and display the specific block used.
4. Rack and cover are included with the 0.5mL, 1.5mL, and 2.0mL Microtube blocks and can be used to transport or store samples. The cover snaps on to the rack to secure the samples.
 - UNIT WILL NOT OPERATE WITHOUT A BLOCK INSTALLED
 - ONCE SECURED DO NOT LIFT UNIT BY THE BLOCK
 - DO NOT ATTEMPT TO OPERATE UNIT WITHOUT A BLOCK PROPERLY INSTALLED
 - DO NOT LIFT BLOCK BY THE RACK OR COVER. RACK AND COVER ARE FOR SAMPLE TRANSPORT ONLY.

NOTE: When using Eppendorf Thermomixer[®] R blocks you may need to calibrate the system for optimal performance.

HELP SCREENS



The Thermal Shake Touch or Cooling Thermal Shake Touch has help screens available when the “?” is displayed on the screen. Look for this icon in the upper right hand corner of the screen to provide assistance while operating the unit.



OPERATING INSTRUCTIONS

The VWR Thermal Shake Touch or VWR Cooling Thermal Shake Touch has been designed to heat/cool (depending on the model) and shake microplates and modular blocks that have been designed to hold various sample vessels such as plates, tubes and vials.

1. Getting ready:

- a. Plug the cord into a properly grounded, 3-pronged outlet. The VWR Thermal Shake or VWR Cooling Thermal Shake Touch is now ready to operate.

2. Setting temperature:

- a. Touch the far left box to bring up the Temperature Setting Window.
- b. Touch the digit you wish to change, the digit will be now be highlighted and ready to set.
- c. Tap the number above or below the blue box to select the desired value. Temperature can be adjusted in 0.1°C increments.
- d. Once the value for the temperature setting is complete, touch “set”.
- e. To turn off temperature control, touch the temperature box and touch “off”.
- f. To start the heating/cooling function, touch the “start” button . Once started, the “pause”  and “stop”  buttons will be available. “Pause” will hold the temperature at its current state. “Stop” will turn off the heating/cooling function.

Temperature Operating Tips:

- The default maximum temperature is 100°C. Maximum temperature can be adjusted or limited in the “Settings” Menu .

OPERATING INSTRUCTIONS



- Heating and Cooling rates can be adjusted when programming by touching the “advanced” button to bring up the choices. Default settings will heat or cool as fast as possible.
- The temperature display on the unit shows the actual temperature of the sensor, not the top plate or sample. The vessel contents being heated may be at a lower temperature depending on the size of the vessel and volume of sample. To fine tune and calibrate the unit see the Single Point Calibration procedure on page 12.

Caution hot indicator:

The caution hot indicator icon light warns that the temperature is above 40°C (104°F). The icon will illuminate and remain on when the temperature reaches approximately 40°C (104°F). When the heat is turned off, the caution hot indicator light will stay on until the temperature falls below 40°C (104°F). The unit will not enter standby mode while the hot surface warning is on.



3. Setting speed:

- a. Touch the center box to bring up the Speed Setting Window.
- b. Touch the digit you wish to change, the digit will be now be highlighted and ready to set.
- c. Tap the number above or below the blue box to select the desired value. Speed can be adjusted in 10 RPM increments.
- d. Once the value for the speed setting is complete, touch “set”.
- e. To turn off speed control, touch the RPM box and touch “off”.
- e. To start the shaking function, touch the “start” button . Once started, the “pause”  and “stop”  buttons will be available. “Pause” will stop the shaking function temporarily. “Stop” will turn off the shaking function.

- f. Alternately the “pulse” button allows for shaking as long as the button is touched. Shaking will stop when “pulse” is released.

* Refer to specifications table for maximum block speed setting. See pages 7-8

4. Setting time

- a. Touch the right box to bring up the Time Setting Window.
- b. Touch the digit you wish to change, the digit will be now be highlighted and ready to set.
- c. Tap the number above or below the blue box to select the desired value. Time can be adjusted in 1 minute increments.
- d. Once the value for the time setting is complete, touch “set”.
- f. Touching the “clear” button will allow the unit to run continuously while counting elapsed time.

Time Operating Tip:

- Time is set in hours:minutes format

5. Turning unit off:

- a. To completely cut off power from the unit, disconnect the power cord from the unit or unplug from the wall outlet.

NOTE: After the unit is idle for 15 minutes, the unit will go into standby and a “power” button icon will appear on the screen. When the heat is turned off, the caution hot indicator light will stay on until the temperature falls below 40°C (104°F). The unit will enter standby mode once the hot surface warning is off. Touch anywhere on the screen to return to the main screen.



OPERATING TIPS

If an interruption of power occurs the following is to be expected:

- If running in program mode, the unit will return to the home screen with a Power Failure message.
- If running in continuous mode the unit will restart and show a Power Failure message. This includes pulling the plug and intentionally disconnecting power from the unit while it is running.
- The Power Failure message will be cleared once the unit is restarted or a button is touched.



SETTINGS

Touch the “settings” icon  to enter the settings menu. Use the up and down arrow buttons to scroll through the setting options.

SOUND (muting audible alarm)

To silence beeper operation, except for error codes, touch the “ON” to change this setting to “OFF”.

LANGUAGE

The default language is English. You can change the language to French, Spanish, Italian, German, and Portuguese. To change the language setting touch the language name until the desired language appears.

MAXIMUM TEMPERATURE

The default maximum temperature limit is 100°C. To protect your samples, the maximum temperature of the unit can be limited. Touch the box next to Maximum Temperature. The Temperature Settings window will appear. Adjust the maximum temperature as needed. This setting will limit the temperature on all existing programs as long as it is active. To return to the default setting, touch the “100°C”.

PROGRAM PRIORITY

There are two ways to count the elapsed time of a program step utilizing the temperature control. Each can be selected by touching the “Program Priority” button in the settings menu.

- Time Priority (default): Time begins to count down as soon as the unit is started. You will see the time begin to count down immediately as the unit heats/cools to the desired set temperature.
- Temperature Priority: Time begins to count only when the set temperature has been reached. The time will not begin to count down until the temperature of the sensor has reached your desired set temperature
- These priority settings affect all temperature steps where a time is set.

USB LOG

When a Flash Drive is connected to the USB port and this setting is enabled, the unit will log data while your saved program is running. This will create a .csv file on your USB drive with data that is easily transferred to a computer for analysis. Data is output to this file once per second.

To enable this function, insert the USB drive, then touch the USB Log button in the Settings menu.

NOTE: The USB drive must have sufficient available memory for this function to work properly. If problems arise, remove the USB drive and replace with a USB drive with more available space.

OPERATING INSTRUCTIONS (CONT'D)

USB PROGRAMS

The Thermal Shake Touch or Cooling Thermal Shake Touch can store up to 5 programs internally and up to 10 programs on a single USB drive. Connect a Flash Drive to the USB port and select the USB Program button on the Settings menu.

To transfer programs from the unit to the USB:

- Select unit program number 01 through 05 to be transferred.
- Select the USB program Number 01 through 10 where you would like the program saved.
- Then touch “To USB” to transfer and save the program from the unit to the USB.
- This process will overwrite programs previously saved at those program numbers.

To transfer programs from the USB to the unit:

- Select USB program number 01 through 10 to be transferred.
- Select the unit program Number 01 through 05 where you would like the program saved.
- Then touch “To unit” to transfer and save the program from the USB to the unit.
- This process will overwrite programs previously saved at those program numbers.

NOTE: The USB drive must have sufficient available memory for this function to work properly. If problems arise, remove the USB drive and replace with a USB drive with more available space.

SINGLE POINT CALIBRATION

This procedure is used to fine tune and calibrate the unit at up to (6) separate set points. Enter the calibration screen by touching the Calibration button in the Settings menu.

1. Secure the block with the appropriate tubes or microplate in place.

2. Fill a vessel in the blocks with mineral oil or your sample.
3. Touch a “sensor temperature” box, enter the desired calibration temperature and touch “set”.
4. The unit will immediately begin to heat/cool to this set point. The “adjusted temperature box” will remain light blue until the set temperature is reached and the sample has stabilized (approximately 10 minutes after reaching set temperature).
5. Measure the temperature of your sample with an external temperature probe or thermometer and enter this value in to the “adjusted temperature” box and touch “set”.
6. Calibration points are not saved until the “done” button is touched. Be sure to touch “done” when finished calibrating your unit.

When using this offset temperature, SPC (Single Point Calibration) will display on the bottom of the temperature screen when running at the SPC temperature set point.

TO RESTORE UNIT TO FACTORY SETTINGS

The Thermal Shake Touch or Cooling Thermal Shake Touch can be restored to factory settings by touching the “Reset all settings” button in the settings menu. Touch “reset” to proceed with restoring the unit to factory settings or “cancel”.

NOTE: By touching “reset” the Beeper preference (sound), Language, Program Priority, USB log, and Temperature calibrations will be restored to default settings. Also, all calibration points and programs will be erased.

SOFTWARE UPDATE

Before updating software, check the current version in the settings menu. To update software follow these steps:

1. Copy the files onto an empty USB drive. These files must be saved in a folder named “CMD” and must be on the root of the drive.

OPERATING INSTRUCTIONS (CONT'D)

- Power the unit on, once the main screen is visible plug the USB drive into the unit.
- The unit will beep immediately after inserting the USB drive, and the unit is now programming itself. DO NOT remove the USB drive at this point! The software update will take approximately 1 minute and may take up to 90 seconds.
- The screen on the unit will now fade in and out. This is normal and should last another 60-90 seconds. Again, DO NOT remove the USB drive during this process.
- When the software update is complete, the unit will automatically restart and return to the main screen. Remove the flash drive, unplug the unit and plug back in. Check the software version on the settings screen to ensure a successful software update.

CREATING, SAVING, EDITING AND MANAGING PROGRAMS

PROGRAMMING (Single Step Program)

- Touch "Program" button.
- Touch the large blue box next to the any program number between 1 and 5 "Tap to add a program".
- Select your parameters. Temperature, Speed, and Time are entered the same way as in the non-program mode.
 - All program steps must have a time entered.
- To select a temperature ramp rate other than default, touch "advanced".
 - Heat/cool rates (depending on model) are able to be set in 0.5°C/min increments
 - Continue to tap the desired temperature rate box until the desired rate is displayed. Touch "set" after selecting the preferred rate.
 - "Default" will allow the unit to heat/cool at its maximum rates.
- If creating a single step program, simply touch "save".

- Select the Program number where you want to save. You can save the program in an empty spot or overwrite an existing program. If you are overwriting an existing program, that program will be highlighted in red and you will need to confirm this overwrite.
- Touch "yes" to confirm overwrite or "no" to save to a different program location.

PROGRAMMING (Multiple Step Program)

- Multiple step programs are created by following steps 1-4 above and touching the "add a step"  button for each addition step, up to 5 steps per program.
- Once all steps have been entered, touch "save" and follow step 6-7 above.
- A multiple step program can also be created by touching the "add a step" button on the main screen to add additional steps.

EDITING AN EXISTING PROGRAM

- Touch "program" button.
- Touch the blue box of the program you wish to edit.
- Use the white up/down arrows to scroll through the program steps to select the parameter(s) you wish to edit.
- Touch the setting and make the desired changes.
- Additional steps may be added up to 5 steps per program by touching the "add a step" button.
- To delete an entire step touch the "delete" button  below the step number.
- Touch "save".
- You can save to an open program spot or overwrite an existing program.
- If you are overwriting an existing program, that program will be highlighted in red and you will need to confirm this overwrite.
- Touch "yes" to confirm overwrite or "no" to save to a different program location.

PROGRAM MANAGEMENT

1. Up to 5 separate programs can be saved on the unit.
2. Programs can be deleted by simply touching the “delete” button under the program number.
3. A multiple step program can also be created by touching the “add a step” button on the main screen to add additional steps.
4. This program can be run immediately for a one time application, or saved for future use. To save the program, touch “save” and use the white up/down arrows to select the position where you want to save this new program.
5. If more than 5 programs need to be saved, refer to the USB Program settings on page 12.

PROGRAMMING TIPS:

- Total program time is indicated to the left of each program.
- The steps and settings for each program will be displayed in the boxes to the right of each program number.
- While a program is running touch the “chart” icon . The status of the program is indicated in the boxes at the top of the screen. The vertical white line visually tracks the progress of the program through all of the steps.
- In the settings menu, if you select Temperature for the Program Priority, your incubation time will not begin until the set temperature is reached.
- You can add an inactive step to a program by leaving the temperature and speed blank and entering a time.

For information or technical assistance contact your local VWR representative or visit vwr.com.

TROUBLESHOOTING

If the unit gives an error code, immediately disconnect from the power source to turn the unit off. See the error table below for proper corrective action. If the error cannot be cleared, please contact your VWR representative for repair.

Error	Cause of Error	How to Fix
Unit fails to power on	Power switch off	Turn power switch on
E1	Temperature sensor opened or malfunctioned	This error cannot be fixed by the end user. Please contact your VWR representative for repair.
E2	The units temperature exceeds set-point temperature	Reset the unit by disconnecting from the power source and let the unit return to room temperature. Adjust the maximum temperature setting if needed. If problem persists after restarting the unit, please contact your VWR representative for repair.
E3	There is either no motion on the motor or the motor is not working properly	Reset the unit by disconnecting from the power source. If problem persists after restarting the unit, please contact your VWR representative for repair.
E4	Motor is not reaching set speed	Ensure the block is secured properly and check there is no mechanical obstruction. Reset the unit by disconnecting from the power source. If problem persists after restarting the unit, please contact your VWR representative for repair.
E5	Motor failure	Remove mechanical obstruction. Reset the unit by disconnecting from the power source. If problem persists after restarting the unit, please contact your VWR representative for repair.

Error codes continue on next page.

TROUBLESHOOTING

Error	Cause of Error	How to Fix
E6	Internal electronic communication error	Reset the unit by disconnecting from the power source. If problem persists after restarting the unit, please contact your VWR representative for repair.
E7	Internal sensor error	Reset the unit by disconnecting from the power source. If problem persists after restarting the unit, please contact your VWR representative for repair.
E8	Unit not recognizing an installed block	Unscrew and remove the block. Reinstall and ensure a secure fit for the block. Reset the unit by disconnecting from the power source. If problem persists after restarting the unit, please contact your VWR representative for repair.
E9	Unit has recognized multiple warnings	Reset the unit by disconnecting from the power source and let the unit return to room temperature. If problem persists after restarting the unit, please contact your VWR representative for repair.
E10	Ambient sensor has detected a temperature exceeding 65°C	Reset the unit by disconnecting from the power source and let the unit return to room temperature. If problem persists after restarting the unit, please contact your VWR representative for repair.

TROUBLESHOOTING

Warning codes: If these codes appear on the display of your unit, there is a possible reduction of performance. You can continue to use the unit with the warning displayed. If you detect a noticeable change in performance of your unit and it is affecting your application, contact your VWR representative for repair.

Warning Code	Cause of Warning
Probe 1 or Probe 2	The temperature of the probe exceeded 110°C. Reset the unit by disconnecting from the power source and let the unit return to room temperature.
Heat Sink Probe	The heat sink probe has a possible malfunction. Reset the unit by disconnecting from the power source.
Fan 1 or Fan 2	Fan 1 or Fan 2 has a possible malfunction. Reset the unit by disconnecting from the power source.

REPLACEMENT PARTS - COOLING THERMAL SHAKE TOUCH

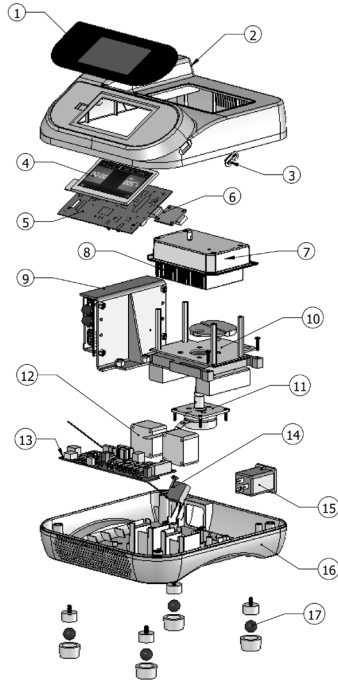

DESCRIPTION	PART NUMBER
1. Front Panel, Touch Screen	380843-00
2. Top Housing	280845-00
3. USB Boot	280883-00
4. LCD Display Assembly	880781-00
5. Display Board	380846-00
6. USB Board	380850-00
7. Heat Plate Skirt	280873-00
8. Cooling/Heating Thermal Assembly	880780-00
9. Power Supply Assembly	880784-00
10. Plastic Pivot Assembly	880782-00
11. Motor/Eccentric Shaft Assembly	880783-00
12. Main Fan	280840-00
13. Main Board	380845-00
14. Power Supply Fan	280841-00
15. Power Inlet - TST	380864-00
16. Bottom Housing	280846-00
17. Rubber Foot	280998-00
Power Cord	120V plug 330100-00 230V, Euro Plug 330101-00

ACCESSORIES

BLOCKS

Vessel Type	No. of Wells	Well Dia.	Well Depth	Dimensions (L x W x H)	Part Number
0.5mL Tube Block with Rack & Cover	30	0.31" (0.79cm)	0.97" (2.46cm)	4.0 x 5.6 x 1.8" (10.2 x 14.2 x 4.6cm)	89232-914
1.5mL Tube Block with Rack & Cover	24	0.44" (1.12cm)	1.39" (3.53cm)	4.0 x 5.6 x 2.1" (10.2 x 14.2 x 5.3cm)	89232-916
2.0mL Tube Block with Rack & Cover	24	0.45" (1.15cm)	1.39" (3.53cm)	4.0 x 5.6 x 2.1" (10.2 x 14.2 x 5.3cm)	89232-916
2.0mL Cryo Tube Block	24	0.50" (1.27cm)	1.39" (3.53cm)	4.0 x 5.6 x 2.2" (10.2 x 14.2 x 5.6cm)	89232-922
12mm Tube Block	24	0.47" (1.20cm)	1.42" (3.61cm)	4.0 x 5.6 x 2.2" (10.2 x 14.2 x 5.6cm)	89232-920
5mL Eppendorf™ Tube Block	9	0.66" (1.68cm)	1.93" (4.9cm)	4.1 x 5.7 x 2.8" (10.4 x 14.5 x 7.1cm)	10810-740
15mL Conical Tube Block	9	0.68" (1.73cm)	4.11" (10.44cm)	4.2 x 5.7 x 5.0" (10.7 x 14.5 x 12.7cm)	89232-924
50mL Conical Tube Block	4	1.18" (3.0cm)	3.97" (10.1cm)	4.0 x 5.7 x 4.8" (10.2 x 14.5 x 12.2cm)	89232-926
Microplate Thermal Block with Lid	1	4.21 x 2.81 x 0.1 (10.7 x 7.1 x 0.25cm)	0.9" (2.3cm)	4.7 x 6.4 x 3.0" (11.9 x 16.3 x 7.6cm)	89232-912
384 Well Plate Block with Lid	384	0.16" (0.4cm)	0.32" (0.81cm)	4.7 x 6.4 x 3.0" (11.9 x 16.3 x 7.6cm)	10810-738
0.2mL PCR Plate Block with Lid	96	0.25" (0.64cm)	0.50" (1.27cm)	4.7 x 6.4 x 3.0" (11.9 x 16.3 x 7.6cm)	10810-870

MANUFACTURED BY:

TROEMNER, LLC

201 Wolf Drive • PO Box 87 • Thorofare, NJ 08086-0087

Phone: 856-686-1600 • Fax: 856-686-1601 • E-mail: troemner@troemner.com

www.troemner.com

715095-00 (REV 7 - 8/16)