



Digital Waving Rotator

88882003 & 88882004

In the United States:

For customer service, call 1-800-766-7000
To fax an order, use 1-800-926-1166
To order online: thermofisher.com

In Canada:

For customer service, call 1-800-234-7437
To fax an order, use 1-800-463-2996
To order online: thermofisher.ca

Find out more at thermofisher.com

ThermoFisher
SCIENTIFIC

Operating Manual

Revision A . 09 03 2019

ThermoFisher
SCIENTIFIC

Contents

Section 1 Important Information	1
Disposing of Product	2
<hr/>	
Section 2 Inspection and Installation	3
Packing List	3
Connections	4
Structure Diagram	4
<hr/>	
Section 3 Overview	5
Specifications	5
Environmental Conditions	5
Safety Instructions	6
Speed and Load	7
<hr/>	
Section 4 Operation	8
Control Panel	8
Installation	9
Settings	9
Accessory Installation	10
<hr/>	
Section 5 Safety Tips and Maintenance	13
<hr/>	
Section 6 Troubleshooting	14
<hr/>	
Section 7 Optional Accessories	15
<hr/>	
Section 8 Warranty Information	16
<hr/>	

Section 1 Important Information

Ignoring the following warnings could cause serious injuries or even fatal accidents.

Check the voltage, phase and capacity of power supply on the ID plate before installation. Connect properly.

Power supply must be properly grounded. Abnormal grounded connection causes serious damage. Grounded connection must not be on the water pipe and gas pipe.

Use provided power cord. Power cord: Wall outlet with grounded terminal power cord 250V 10A.

Do not install the product in a place that gas could leak. Do not use in a place that has industrial oil smoke or metallic dust. It causes fire or electric shock. Do not use the machine near to places where explosion could happen due to organic evaporating gases.

Explosive materials: acid, ester, nitro compound.

Inflammable materials: salt peroxides, inorganic peroxide, salt acids.

Check equipment for permissible environmental conditions when using inside of Temperature and Humidity Chamber or Incubator. It can be the cause of fire or trouble by stirrer electricity, electronic, and damage of motor.

Rotator's permissible environmental condition. Temperature 5°C to 40°C, Maximum relative humidity 80%.

Unplug if there is a strange sound, smell and/or smoke from the product. Stop

operating and request the service.

Keep out of the direct sunlight. It may influence product life and proper operation.

Do not use the machine at places where moisture is high and flooding can happen.

Do not assemble, repair, modify on your own. The product may not work well and electric shock is possible with changes in the efficiency of the product. Also this will void the warranty.

Indicates a hazardous situation which, if not avoided, may result in minor or moderate injury.

Do not put heavy things on the power cord. Do not put the machine on the cord. It may take off the wire coating and cause electric shock or fire.

Do not touch it with wet hands and place the main plug correctly. It could cause the electric shock or injuries.

Installing power outlet near instrument may be convenient

Do not install the stirrer near machinery generating high frequency noise. Avoid installation close to high frequency-welding machine, sewing machine, or mass SCR controller.

Do not inject any liquid and inflammable things inside of product.

Do not pour water or put liquid on the top of the product when cleaning. Disconnect the main power immediately and request the service if water may be in the product.

Do not let the product take any strong shock or vibration. It could cause abnormal operation or trouble. It may deteriorate the ability of the product operation and not obtain correct results.

Do not sprinkle insecticide or flammable spray on the product. Use smooth cloths. Cleaning with solvent can cause fire and deformity.

Power off while product cleaning. It may cause electric shock or fire.

Do not drop or allow the machine to fall. It will cause wrong operation and malfunction.

Disposing of Product

Dispose the unit with separating plastic mold, and motor.

Section 2 Unpacking and Installation









Before unpacking the unit, first check for damages in the package of the unit.

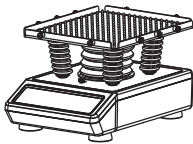
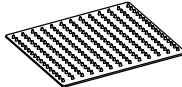

Then unpack the unit. Check carefully to see if there were damages incurred during transit.

After unpacking, check that all unit parts and accessories are as listed below. Contact us or the agent from which you purchased the unit if any components were omitted.

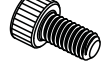
2.1 Packing List

Table -1. Packing List

Description	Catalog Number		Figure
Digital Waving Rotator	88882003	88882004	
*Dimpled Rubber Mat	1	1	
General Power Adaptor	1	1	
US Plug	1	N/A	
CN Plug	N/A	1	
EU Plug	N/A	1	
UK Plug	N/A	1	
*Screw for Rubber Strip	10	10	
Rubber Strip	6	6	

Allen Wrench	1	1	
**Rubber Tube Replacement	2	2	

*Has been installed on the instrument.

**For replacement purpose.

2.2 Connections

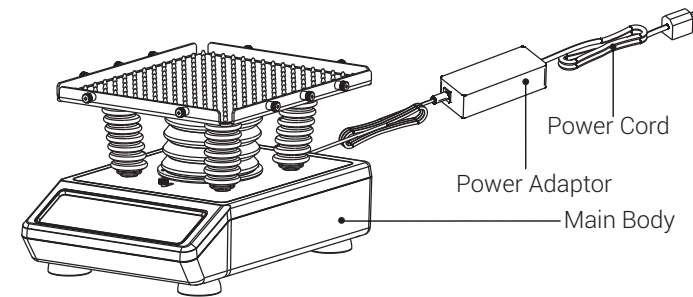

2.3 Structure Diagram

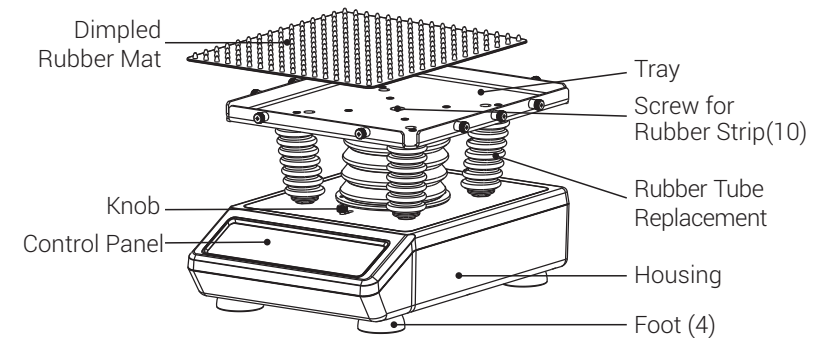

Section 3 Overview

3.1 Specifications

Rotation Speed	Speed Range.....5~120rpm Display Accuracy.....1rpm Speed Accuracy..... $\pm 1\text{rpm} \leq 30\text{rpm}$, $\pm 2\text{rpm} > 30\text{rpm}$
Rocking Angle	Operation Mode.....3D Circular Motion Carousel Angle Range.....1°~12°Adjustable
Load	Maximum Load (Centered on tray).....9.8kg
Time	Timing Range.....1min.~99h59min.
Size	Overall Dimensions.....383×295×224mm Tray Dimensions.....316×276×19mm Packaging Dimensions.....487×387×354mm
Weight	Net Weight.....13.5Kg(29.8lb) Gross Weight.....15.8Kg(34.8b)
Power Supply	Requirement.....AC100-240V, 50/60Hz, 0.2A
Others	Certification.....RoHS, WEEE, cCSAus, CE Mark Noise Level..... $\leq 55\text{dB}$ with no load

3.2 Environmental Conditions

Application Environmental Conditions: indoor use	
Temperature.....	5 to 40°C
Voltage Fluctuation.....	$\pm 10\%$ of the nominal voltage
Altitude.....	$\leq 2,000$ m
Humidity.....	20% to 85%

Storage Environmental Conditions
Temperature.....0 to 60°C
Humidity.....20% to 90%, non-condensing

3.3 Safety Instructions

Please read the entire instruction manual before operating the Digital Waving Rotator.

⚠ WARNING DO NOT use the Digital Waving Rotator in a hazardous atmosphere or with hazardous materials for which the unit was not designed. Also, the user should be aware that the protection provided by the equipment may be impaired if accessories used are not provided or recommended by the manufacturer, or are used in a manner not specified by the manufacturer.

CAUTION ! To avoid electrical shock, completely cut off power to the unit by disconnecting the power cord from the unit or unplug from the wall outlet. Disconnect unit from the power supply prior to maintenance and service. Any spills should be removed promptly. Bio hazard spills should be cleaned using approved liquid promptly. Solvent spills are a fire hazard.

Stop the unit immediately, and DO NOT operate until clean up is complete and vapors have dissipated.

DO NOT immerse the unit for cleaning.

DO NOT operate the unit if it shows signs of electrical or mechanical damage.

Position of Loads

Place the loads in the recommended positions below:

1. Place load at the center of the tray
2. Place loads symmetrically around the center of the tray
3. Make sure to use rubber strips to fasten containers onto the tray

Symmetrical placement

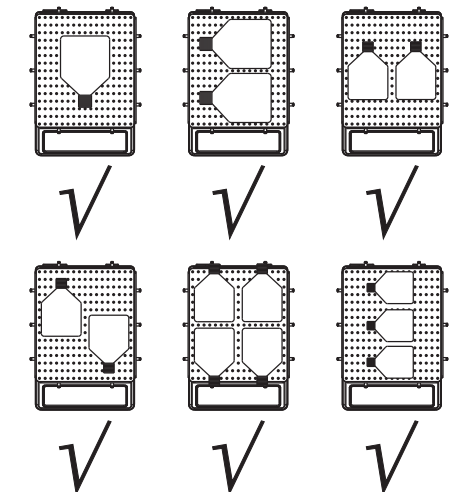

Section 4 Operation

This chapter covers the control panel and its operation.

4.1 Control Panel

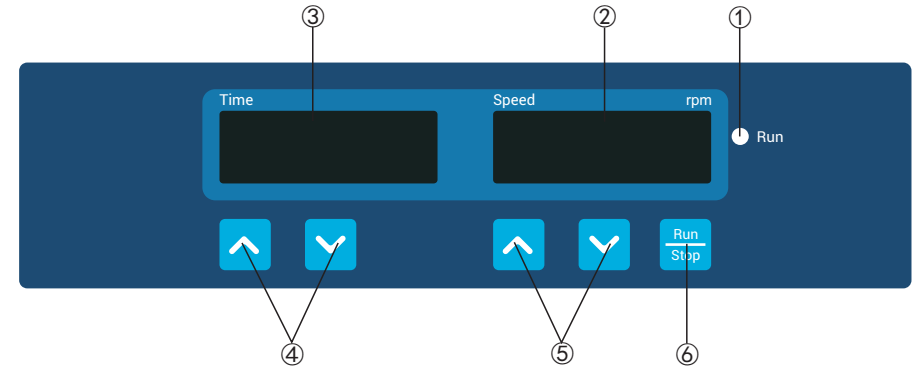

- ① Run indicator: The light is on when the instrument is running and off when the instrument is in standby.
- ② Speed display window: The window displays set speed (when the instrument is in standby) or current speed (when the instrument is running).
- ③ Time display window: The window displays cumulative time (in continuous mode) or remaining time (in timer mode).

- ④ Time setting buttons: UP/DOWN arrow buttons are used to increase/decrease the set time of the instrument.
- ⑤ Speed setting buttons: UP/DOWN arrow buttons are used to increase/decrease the set speed of the instrument.
- ⑥ Run/Stop button: Start or stop the instrument.

Asymmetrical placement

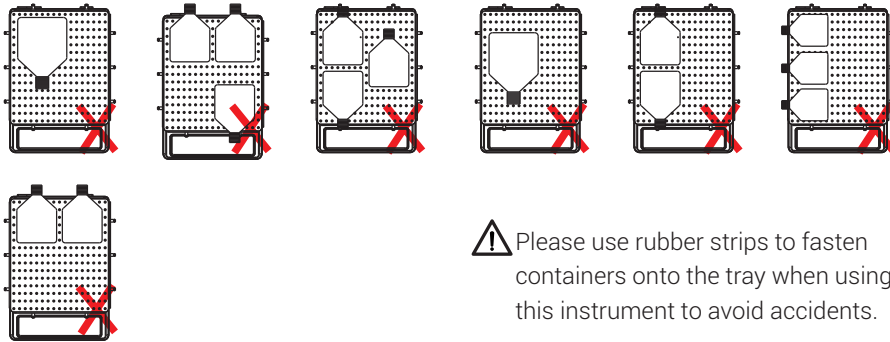

⚠ Please use rubber strips to fasten containers onto the tray when using this instrument to avoid accidents.

3.4 Speed and Load

	Load Weight (kg)	Placement of Load	Tilt Angle	Rotation Speed (rpm)
Tilt Angle 0°	9.8	Centered	0°	120
	9.8	Symmetrical	0°	120
Tilt Angle 12°	9.8	Centered	12°	70
	5	Centered	12°	100
	1	Centered	12°	120
	9.8	Symmetrical	12°	70
	5	Symmetrical	12°	100
	1	Symmetrical	12°	120

Warning: The actual maximum rotation speed of the instrument may be affected if the cell culture flask is placed at the

corner or one side of the tray. If such placement is needed, please make sure to gradually increase the speed.

4.2 Installation

1. Connect all the components according to the figures shown on page 4 of this manual. Use grounded power outlet.
2. Press the power switch "I" side and switch on the instrument.

4.3 Settings

Time Settings

1. Continuous mode

Press the "▲" or "▼" arrow button below the Time display window. When the number shown on the Time display window starts flashing, press "▼" arrow button to decrease the time to 00:00 and then release the button. The time setting is finished after the number shown on the Time display window flashed twice.

2. Timer mode

Press the "▲" or "▼" arrow button below the Time display window. When the number shown on the window starts flashing, press "▲" or "▼" arrow button to increase or decrease the time value. Release the button when the time shown on the Time display window reaches the set value. The time setting is finished after the number shown on the Time display window flashed twice.

Speed Settings

Press the "▲" or "▼" arrow button below the Speed display window. When

the number shown on the Speed display window starts flashing, press "▲" or "▼" arrow button to increase or decrease the speed value. Release the button when the speed shown on the Speed display window reaches the set value. The speed setting is finished after the number shown on the Speed display window flashed twice.

Note: press the "▲" or "▼" arrow button for a longer time to accelerate the setting.

Run and Stop

Press "Run/Stop" button and the instrument will start running with the specified settings and the Run indicator light will be on.

The Time display window will show the cumulative time (Continuous Mode), or remaining time (Timer Mode) and the Speed display window will show the current speed.

Press "Run/Stop" button again and the instrument will slow down until it stops. The instrument will then be in standby and the two display windows will show the set values.

Note: To ensure shaking operation smooth and steady, it may take 1 minute for the microprocessor control system to accelerate the tray to the set speed.

Finish Operation

After the operation is finished, press the

power switch at the back right side the instrument and put it into the "O" state. Unplug the instrument and store the instrument according to the storage guide.

Alarm System

Err1: If running speed does not match the setting speed, the instrument will have a three-time reboot, and after the three reboots failed, there will be a buzzer, and then Err1 will be displayed in the Speed display window .

End of timer: The instrument buzzing alarm, the "End" is displayed in the Speed window.

When the instrument alarms, press any key, the instrument is back to the standby mode.

Power Recovery

If the power supply is cut off suddenly while the instrument is in operation, the unit will automatically run at the previously set parameter upon power restoration. The display windows will flash. Press any button to stop flashing.

4.4 Accessory Installation

Tilt Angle Adjustment

1. Make sure the instrument is not running while adjusting the tilt angle. Press the Stop button to stop the instrument if it is in running.
 2. Push the knob on the cover plate from "Run" to "Adjust Angle" position as shown in figure 1.
 3. Take off the dimpled rubber mat and put it aside.
 4. Hold the tray with one hand and unscrew the inner hexagon screw at the center of the tray with the angle adjustment wrench to adjust the angle of the tray with the other hand, as shown in figure 2.
 5. Apply upward force at the front of the tray and downward force at the back of the tray to adjust the tray to the desired angle, as shown in figure 3.
 6. Hold the tray with one hand and tighten the inner hexagon screw with the allen wrench at the center of the tray until it's fastened, as shown in figure 4.
 7. Push the knob on the cover plate from "Adjust Angle" to "Run" position as shown in figure 5.
 8. Put on the dimpled rubber mat and complete the angle adjustment, as shown in figure 6.
 9. Follow steps on Section 4.3 to operate the equipment.
- Now you can start using this Digital Waving Rotator.

Figure 1

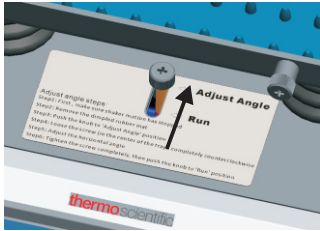

Figure 5

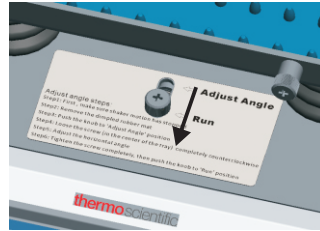

Figure 2

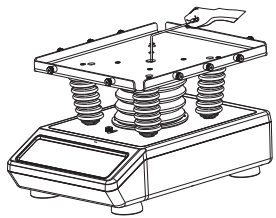

Figure 6

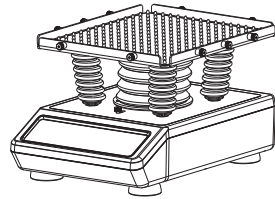
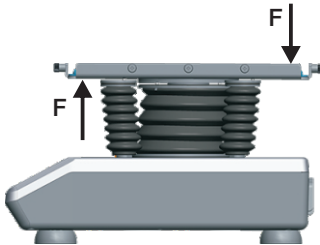

Figure 3



Warning:

1. The instrument should be unloaded and stopped at the specified position when adjusting the angle. It is not allowed to adjust the angle at other positions.
2. The instrument can be started only when the knob is at the "Run" position after the angle adjustment. Otherwise the instrument may be damaged.

Figure 4

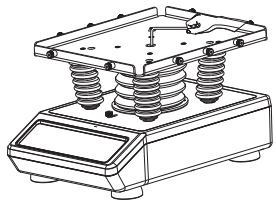

Replace The Rubber Tube Replacement

If the Rubber Tube Replacement worn out after a long time using, please follow the steps below to replace these rubber tubes.

1. Remove the dimpled rubber mat, and then loosen the screws (located at A, B, C, D) of tray with a cross screwdriver.

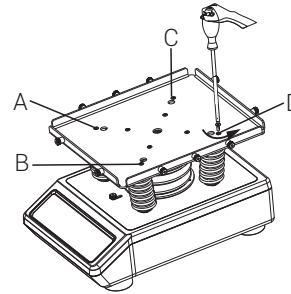

2. Hold the bottom of the Rubber Tube Replacement to loosen it, or to loosen the screw in the Rubber Tube Replacement with a cross screwdriver.

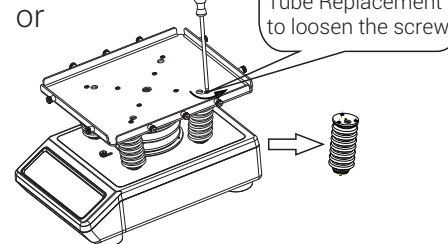
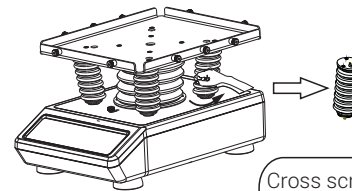

3. Place the new Rubber Tube Replacement in place and tighten it just with hand or tighten the screw in the Rubber Tube Replacement with a cross screwdriver.

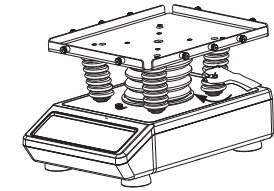

OR

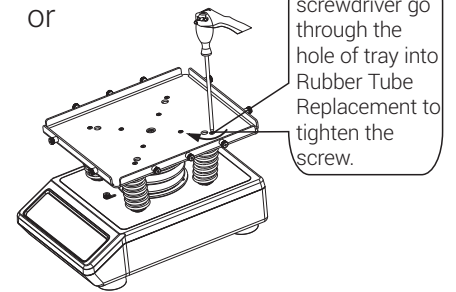

4. Tighten the screws of the tray and put back the dimpled rubber mat onto the tray.

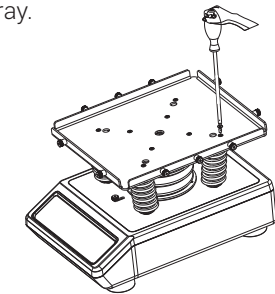

Section 5 Safety Tips and Maintenance

Safety Tips

1. Use independent power supply.
2. Check if the local power supply voltage is suitable for use.
3. Do not drag the power supply cable when unplugging.
4. Do not use non-specified power cable or damage cable.
5. Service should only be performed by a qualified professional.
6. The power supply must be unplugged under the following situations:
 - (1). When the unit is moved
 - (2). When the electrical cabinet or the moving component is opened
 - (3). When the equipment is malfunctioning
 - (4). When the equipment is not in use

Maintenance

Instrument case and tray surface can be cleaned with cloth with mild detergent and water. Surface of the dimpled rubber mat can be cleaned with mild detergent or water and then wiped with clean cloth.

Warning: Avoid dripping detergent or water into the inside of the instrument during cleaning.

Clean Spill

If accidental spillage of liquids caused by mishandling or contained breakage occurs on the surface of the instrument, please shut down the instrument and clean up the liquid immediately.

If the liquid has already spilled into the unit, cut off the power supply first and immediately clean up the liquid at the surface of the instrument. Place the instrument in a ventilated and dry environment for 24 hours before reuse. If the instrument is not functioning after drying for 24 hours, please contact the manufacturer.

Warning: Disassembling/Assembling without a qualified professional's guidance may cause malfunctioning of the instrument.

Section 6 Troubleshooting

Please refer to the following table to troubleshoot if any malfunction occurs.

If the problem still exists, contact your local sales representative.





Error	Cause	Solution
Cannot start instrument, LED display window off	Power disconnected	Connect the power
	Power switch off	Switch on power
	Power adaptor failure	Replace power adaptor
No shaking of the tray	Over-weighted or unbalanced load	Adjust the weight and position of load, decrease rotation speed
	Push the knob to "Adjust Angle" position	Push the knob to "Run" position
	Electrical malfunction	Contact Thermo Scientific
	Mechanical malfunction	Contact Thermo Scientific
Loud noise	Platform shaking	Place Instrument on a firm surface
	Tray loose	Fasten screws
	Over-weighted or unbalanced load	Adjust the weight and position of load, decrease rotation speed
Other	Keep record for maintenance	

Note:

Err1 – Speed alarm

If Err1 occurs, please contact Thermo Scientific Customer Service for solutions.

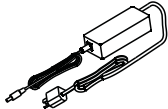
Section 7 Optional Accessories

Description	Cat. No.	Dimensions	Max. Qty.	Figure
Rubber Mat	88882101	298x258x5mm	1	
Dimpled Rubber Mat	88882102	298x258mm	1	
Rubber Strips 6 Ea/pack	88882103	180x7mm	5	
General Power Adaptor w/US plug	88870126	125VAC 10A 1.8m	1	
General Power Adaptor w/AUS, CN plug	88870127	250VAC 10A 1.8m	1	
General Power Adaptor w/EU plug	88870128	250VAC 16A 1.8m	1	
General Power Adaptor w/UK plug	88870129	250VAC 13A 1.8m	1	
Rubber Tube Replacement	88882128	Φ44×108mm	4	
Screw for Rubber Strips	88882129	M4x8 (8pcs/pack)	10	

Section 8 Warranty

THERMO FISHER SCIENTIFIC STANDARD PRODUCT WARRANTY

The Warranty Period starts two weeks from the date your equipment is shipped from our facility. This allows for shipping time so the warranty will go into effect at approximately the same time your equipment is delivered. The warranty protection extends to any subsequent owner during the first year warranty period.

During the first two (2) years, component parts proven to be non-conforming in materials or workmanship will be repaired or replaced at Thermo's expense, labor included. Installation and calibration are not covered by this warranty agreement. The Technical Services Department must be contacted for warranty determination and direction prior to performance of any repairs. Expendable items, glass, filters and gaskets are excluded from this warranty.

Replacement or repair of components parts or equipment under this warranty shall not extend the warranty to either the equipment or to the component part beyond the original warranty period. The Technical Services Department must give prior approval for return of any components or equipment. At Thermo's option, all non-conforming parts must be returned to Thermo Fisher Scientific postage paid and replacement parts are shipped FOB destination.

THIS WARRANTY IS EXCLUSIVE AND IN LIEU OF ALL OTHER WARRANTIES, WHETHER WRITTEN, ORAL OR IMPLIED. NO WARRANTIES OF MERCHANTABILITY OR FITNESS FOR A PARTICULAR PURPOSE SHALL APPLY. Thermo shall not be liable for any indirect or consequential damages including, without limitation, damages relating to lost profits or loss of products.

Your local Thermo Sales Office is ready to help with comprehensive site preparation information before your equipment arrives. Printed instruction manuals carefully detail equipment installation, operation and preventive maintenance.

If equipment service is required, please call your Technical Services Department at 1-866-984-3766, option number 2. We're ready to answer your questions on equipment warranty, operation, maintenance, service and special application. Outside the USA, please contact local Thermo Technical Services Department or local distributor for warranty information.