

# ÄKTA™ pure

## User Manual

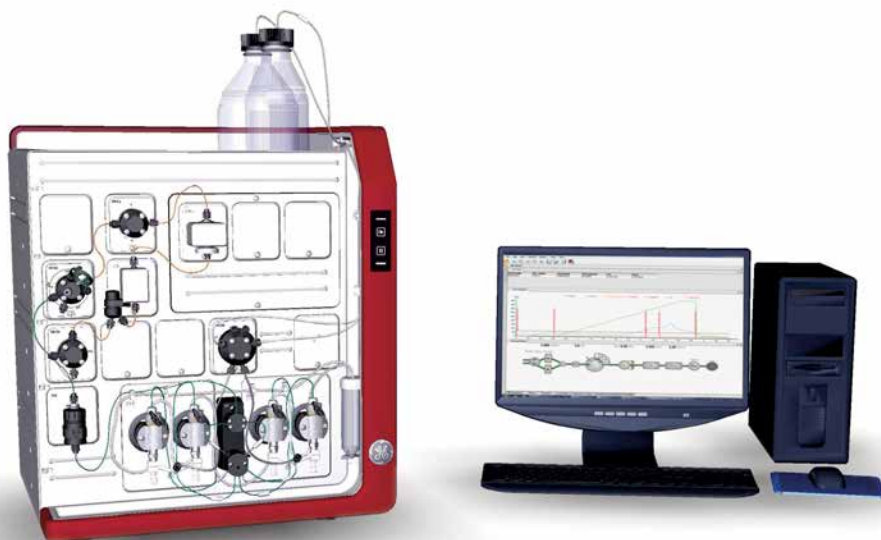

# Table of Contents

<b>1</b>	<b>Introduction .....</b>	<b>6</b>
1.1	Important user information .....	7
1.2	ÄKTA pure overview .....	9
1.3	ÄKTA pure user documentation .....	11
<b>2</b>	<b>The ÄKTA pure instrument .....</b>	<b>13</b>
2.1	Overview illustrations .....	14
2.2	Liquid flow path .....	25
2.3	Instrument control panel .....	27
2.4	Instrument modules .....	32
2.4.1	System pumps .....	33
2.4.2	Mixer .....	37
2.4.3	Valves, overview .....	38
2.4.4	Inlet valves .....	39
2.4.5	Mixer valve .....	46
2.4.6	Injection valve .....	49
2.4.7	Loop valve .....	52
2.4.8	Column valves .....	55
2.4.9	Versatile valve .....	59
2.4.10	pH valve .....	60
2.4.11	Outlet valves .....	64
2.4.12	Pressure monitors .....	67
2.4.13	UV monitors .....	69
2.4.14	Conductivity monitor .....	72
2.4.15	Flow restrictor .....	74
2.5	Installation of internal modules .....	76
2.6	Accessories .....	79
<b>3</b>	<b>ÄKTA pure external modules .....</b>	<b>86</b>
3.1	External air sensors .....	87
3.2	Fraction collector F9-C .....	89
3.2.1	Function .....	90
3.2.2	Fraction collector F9-C illustrations .....	92
3.2.3	Cassettes, Cassette tray and racks .....	96
3.2.4	Connect tubing to the ÄKTA pure instrument .....	102
3.3	Fraction collector F9-R .....	103
3.4	Sample pump S9 and S9H .....	107
3.5	I/O-box E9 .....	111
3.5.1	Overview of the I/O-box .....	112
3.5.2	Analog connector and signals .....	114
3.5.3	Digital connector and signals .....	116
3.5.4	Connect external equipment to the I/O-box .....	118
3.6	Connection of external modules .....	121
<b>4</b>	<b>System configuration .....</b>	<b>123</b>
4.1	Configuration overview .....	124
4.2	Configure modules .....	130
4.2.1	Configuration of inlet valves .....	131
4.2.2	Configuration of Mixer valves .....	132
4.2.3	Configuration of Loop valves .....	133
4.2.4	Configuration of column valves .....	134

4.2.5	Configuration of Versatile valves .....	136
4.2.6	Configuration of pH valves .....	137
4.2.7	Configuration of outlet valves .....	138
4.2.8	Configuration of UV monitors .....	139
4.2.9	Configuration of Conductivity monitor .....	140
4.2.10	Configuration of external air sensors .....	141
4.2.11	Configuration of fraction collectors .....	142
4.2.12	Configuration of I/O-box .....	144
4.3	General system settings .....	145
<b>5</b>	<b>Operation .....</b>	<b>148</b>
5.1	Before you prepare the system .....	149
5.2	Prepare the flow path .....	150
5.3	Start UNICORN and connect to system .....	157
5.4	Prime inlets and purge pump heads .....	160
5.4.1	System pumps .....	161
5.4.2	Sample pump .....	167
5.5	Connect a column .....	172
5.6	Pressure alarms .....	176
5.7	Sample application .....	179
5.7.1	Sample application using direct injection onto the column .....	180
5.7.2	Sample application using a Superloop™ .....	182
5.7.3	Sample application using a sample loop .....	189
5.8	Fractionation .....	192
5.8.1	Prepare Fraction collector F9-C .....	193
5.8.2	Prepare Fraction collector F9-R .....	199
5.8.3	Fractionation overview .....	206
5.9	Create a method and perform a run .....	210
5.9.1	Create a method .....	211
5.9.2	Prepare and perform a run .....	216
5.9.3	Monitor a run .....	218
5.9.4	After run procedures .....	220
<b>6</b>	<b>Performance tests .....</b>	<b>224</b>
6.1	General performance test actions .....	225
6.2	Air sensor A and Inlet valve A tests .....	228
6.3	Air sensor B and Inlet valve B tests .....	230
6.4	Air sensor S and Sample inlet valve tests .....	232
6.5	Column valve C tests .....	234
6.6	Fraction collector F9-C test .....	236
6.7	Fraction Collector F9-R Test .....	239
6.8	Sample pump tests .....	241
6.9	System Test UV U9-L (fixed) .....	243
6.10	System Test UV U9-M (variable) .....	247
<b>7</b>	<b>Maintenance .....</b>	<b>251</b>
7.1	Maintenance Manager .....	252
7.2	Maintenance program .....	258
7.3	Weekly maintenance .....	261
7.3.1	Change pump rinsing solution .....	262
7.3.2	Replace the inline filter .....	266
7.3.3	Clean the Fraction collector F9-C sensors .....	267
7.4	Monthly maintenance .....	269

7.5	Semiannual maintenance .....	272
7.5.1	Clean the UV flow cell .....	273
7.5.2	Replace the pH electrode .....	275
7.6	Maintenance when required .....	276
7.6.1	Clean the instrument externally .....	277
7.6.2	Perform System CIP .....	278
7.6.3	Perform Column CIP .....	284
7.6.4	Clean Fraction collector F9-C .....	288
7.6.5	Clean Fraction collector F9-R .....	290
7.6.6	Storage of the pH electrode .....	291
7.6.7	Clean the pH electrode .....	293
7.6.8	Clean the pump head check valves .....	296
7.6.9	Wipe off excess oil from the pump head .....	299
7.6.10	Clean the Conductivity flow cell .....	300
7.7	Calibration procedures .....	302
7.7.1	Calibrate the pH monitor .....	303
7.7.2	Calibrate the pressure monitors .....	305
7.7.3	Calibrate the Conductivity monitor .....	308
7.7.4	Calibrate the UV monitors .....	312
7.8	Replacement procedures .....	316
7.8.1	Replace tubing and connectors .....	317
7.8.2	Replace internal tubing in Fraction collector F9-C .....	319
7.8.3	Replace the Mixer .....	322
7.8.4	Replace the O-ring inside the Mixer .....	323
7.8.5	Replace the UV monitor U9-M flow cell .....	325
7.8.6	Replace the UV monitor U9-L flow cell .....	328
7.8.7	Replace Flow restrictor .....	330
7.8.8	Replace the inlet filters .....	331
7.8.9	Replace the pump head check valves .....	332
7.8.10	Replace pump piston seals of Pump P9 or P9H .....	335
7.8.11	Replace pump piston seals of Pump P9-S .....	344
7.8.12	Replace pump pistons .....	351
7.8.13	Replace pump rinsing system tubing .....	352
<b>8</b>	<b>Troubleshooting .....</b>	<b>355</b>
8.1	Introduction to troubleshooting .....	356
8.2	Troubleshooting: General Checklist .....	358
8.3	Troubleshooting: Monitors .....	360
8.4	Troubleshooting: Valves .....	375
8.5	Troubleshooting: Fraction collector .....	377
8.6	Troubleshooting: Pumps .....	387
8.7	Troubleshooting: Other components .....	394
8.8	Troubleshooting: Instrument communication .....	401
8.9	Troubleshooting: Method development .....	403
8.10	Error codes .....	404
<b>9</b>	<b>Reference information .....</b>	<b>410</b>
9.1	System specifications .....	411
9.2	Module specifications .....	413
9.3	Tubing and connectors .....	420
9.4	Recommended tubing kits for prepacked columns .....	428
9.5	Chemical resistance guide .....	431
9.5.1	General information about biocompatibility and chemical resistance .....	432
9.5.2	Chemical resistance specifications .....	433
9.6	Wetted materials .....	436

9.7	Predefined methods and phases .....	438
9.7.1	Predefined purification methods .....	439
9.7.2	Predefined maintenance methods .....	445
9.7.3	Predefined phases .....	446
9.8	System settings .....	448
9.8.1	System settings - UV .....	449
9.8.2	System settings - Conductivity .....	450
9.8.3	System settings - pH .....	451
9.8.4	System settings - Pressure alarms .....	452
9.8.5	System settings - Air sensor .....	454
9.8.6	System settings - I/O-box .....	456
9.8.7	System settings - Fraction collection .....	457
9.8.8	System settings - Tubing and Delay volumes .....	459
9.8.9	System settings - Wash settings .....	461
9.8.10	System settings - Watch parameters .....	462
9.8.11	System settings - Advanced .....	463
9.8.12	System settings - Data collection .....	464
9.9	Manual instructions .....	465
9.9.1	Manual instructions - Pumps .....	466
9.9.2	Manual instructions - Flow path .....	470
9.9.3	Manual instructions - Monitors .....	472
9.9.4	Manual instructions - Fraction collection .....	473
9.9.5	Manual instructions - I/O-box .....	477
9.9.6	Manual instructions - Alarms .....	478
9.9.7	Manual instructions - Wash settings .....	481
9.9.8	Manual instructions - Watch parameters .....	482
9.9.9	Manual instructions - Advanced .....	483
9.9.10	Manual instructions - Other .....	486
9.10	Available Run data .....	487
9.11	Available Curves .....	490
9.12	Injection volumes and peak broadening .....	492
9.13	Delay volumes .....	493
9.14	Component volumes .....	498
9.15	Pressure control .....	500
9.16	Node IDs .....	502
<b>10</b>	<b>Ordering information .....</b>	<b>505</b>
	<b>Index .....</b>	<b>513</b>

# 1 Introduction

## Purpose of the User Manual

The User Manual provides you with instructions and information to run the ÄKTA pure system. It also includes relevant guidance for practical handling and maintenance of instrument components.

---

## In this chapter

This chapter contains the following sections:

Section	See page
1.1 Important user information	7
1.2 ÄKTA pure overview	9
1.3 ÄKTA pure user documentation	11

---

## 1.1 Important user information

### Read this before operating ÄKTA pure



**All users must read the entire *ÄKTA pure Operating Instructions* before installing, operating, or maintaining the instrument.** Always keep the *ÄKTA pure Operating Instructions* at hand when operating ÄKTA pure.

Do not operate ÄKTA pure in any other way than described in the user documentation. If you do, you may be exposed to hazards that can lead to personal injury and you may cause damage to the equipment.

---

### Intended use

ÄKTA pure is intended for purification of bio-molecules, in particular proteins, for research purposes by trained laboratory staff members in research laboratories.

ÄKTA pure shall not be used in any clinical procedures, or for diagnostic purposes.

---

### Prerequisites

In order to operate the system according to the intended purpose, it is important that:

- you have a general understanding of how the computer and the Microsoft® Windows® operating system work.
  - you understand the concepts of liquid chromatography.
  - you have read and understood the Safety instructions chapter in *ÄKTA pure Operating Instructions*.
  - a user account has been created according to UNICORN™ Administration and Technical Manual.
- 

### Safety notices

This user documentation contains safety notices (WARNING, CAUTION, and NOTICE) concerning the safe use of the product. See definitions below.



#### **WARNING**

**WARNING** indicates a hazardous situation which, if not avoided, could result in death or serious injury. It is important not to proceed until all stated conditions are met and clearly understood.



**CAUTION**

**CAUTION** indicates a hazardous situation which, if not avoided, could result in minor or moderate injury. It is important not to proceed until all stated conditions are met and clearly understood.



**NOTICE**

**NOTICE** indicates instructions that must be followed to avoid damage to the product or other equipment.

**Notes and tips**

**Note:** *A Note is used to indicate information that is important for trouble-free and optimal use of the product.*

**Tip:** *A tip contains useful information that can improve or optimize your procedures.*

---



## 1.2 ÄKTA pure overview

### Introduction

ÄKTA pure is intended for purification of bio-molecules, in particular proteins, for research purposes by trained laboratory staff members in research laboratories.

This section gives an overview of the ÄKTA pure instrument and the UNICORN software. For detailed information about UNICORN, see the UNICORN manuals listed in [UNICORN user documentation, on page 12](#). For detailed information about the instrument, see [Chapter 2 The ÄKTA pure instrument, on page 13](#).

---

### Main features

The main features of ÄKTA pure are listed below.

- ÄKTA pure is a flexible system that allows the user to configure both hardware and software to meet many purification needs.
  - The instrument can be easily extended with additional valves, detectors and fraction collectors.
  - There are a large number of different hardware modules to choose from. The user can adjust, for example, the number of columns, inlets, outlets and detectors and choose between different ways to apply and collect samples.
  - Purification and maintenance methods are easily created using predefined methods and method phases. A method phase refers to a specific step/part in the method, such as column wash or elution. Method phases are described in **Phase Properties** and are displayed graphically in a method outline. This makes methods and phases easy to understand and edit.
  - ÄKTA pure is controlled by the UNICORN software: a complete package for control, supervision and evaluation of chromatography instruments and purification runs.
  - UNICORN has different software licence options, such as Design of Experiments (DoE) and Column logbook, to further add user support.
- 

### UNICORN modules overview

UNICORN consists of four modules: **Administration**, **Method Editor**, **System Control** and **Evaluation**. The main functions of each module are described in the following table.

Module	Main functions
<b>Administration</b>	Perform user and system setup, system log and database administration.

Module	Main functions
<b>Method Editor</b>	<p>Create and edit methods using one or a combination of:</p> <ul style="list-style-type: none"> <li>• Predefined methods with built-in application support</li> <li>• Drag-and-drop function to build methods with relevant steps</li> <li>• Line-by-line text editing</li> </ul> <p>The interface provides easy viewing and editing of run properties.</p>
<b>System Control</b>	<p>Start, monitor and control runs. The current flow path is illustrated in the <b>Process Picture</b>, which allows manual interactions with the system and provides feedback on run parameters.</p>
<b>Evaluation</b>	<p>Open results, evaluate runs and create reports.</p> <p>The default <b>Evaluation</b> module includes a user interface optimized for workflows like quick evaluation, compare results and work with peaks and fractions.</p> <p>To perform operations like Design of Experiments, users can easily switch to <b>Evaluation Classic</b>.</p>

When working with the modules **Administration**, **Method Editor**, **System Control** and **Evaluation** it is possible to access descriptions of the active window by pressing the **F1** key. This can be especially helpful when editing methods

## 1.3 ÄKTA pure user documentation

### Introduction

This section describes the user documentation that is delivered with ÄKTA pure.

---

### User documentation

The user documentation listed in the table below is delivered with ÄKTA pure. It is also available on the user documentation CD.

Document	Main contents
ÄKTA pure Operating Instructions	Instructions needed to install, operate and maintain ÄKTA pure in a safe way.
Fraction collector F9-C and F9-R Operating Instructions	Instructions needed to install, operate and maintain Fraction collectors F9-C and F9-R in a safe way.
Sample pump S9 and S9H Operating Instructions	Instructions needed to install, operate and maintain Sample pump S9 and S9H in a safe way.
ÄKTA pure User Manual	Detailed instrument and module descriptions and instructions on how to run, maintain and troubleshoot the system.

## UNICORN user documentation

The user documentation listed in the following table is available from the **Help** menu in UNICORN or from the **UNICORN Online Help and Documentation** software accessed by pressing the **F1** key in any UNICORN module.

Documentation	Main contents
UNICORN Help	Descriptions of UNICORN dialog boxes (available from the <b>Help</b> menu).
Getting started with Evaluation <b>Note:</b> <i>Available in UNICORN 7.0 and later.</i>	<ul style="list-style-type: none"><li>• Video clips showing common workflows in the Evaluation module.</li><li>• Overview of features of the Evaluation module.</li></ul>
UNICORN Method Manual <sup>1</sup>	<ul style="list-style-type: none"><li>• Overview and detailed descriptions of the method creation features in UNICORN.</li><li>• Workflow descriptions for common operations.</li></ul>
UNICORN Administration and Technical Manual <sup>1</sup>	<ul style="list-style-type: none"><li>• Overview and detailed description of network setup and complete software installation.</li><li>• Administration of UNICORN and the UNICORN database.</li></ul>
UNICORN Evaluation Manual <sup>1</sup>	<ul style="list-style-type: none"><li>• Overview and detailed descriptions of the Evaluation Classic module in UNICORN.</li><li>• Description of the evaluation algorithms used in UNICORN.</li></ul>
UNICORN System Control Manual <sup>1</sup>	<ul style="list-style-type: none"><li>• Overview and detailed description of the system control features in UNICORN.</li><li>• Includes general operation, system settings and instructions on how to perform a run.</li></ul>

<sup>1</sup> Current UNICORN version is added to the title of the manual.

## Additional literature

For practical tips on chromatography, refer to *ÄKTA Laboratory-scale: Chromatography Systems Instrument Management Handbook* (product code 29010831).

---

# 2 The ÄKTA pure instrument

## About this chapter

This chapter provides an overview of the ÄKTA pure instrument. It also describes the internal instrument components and how these are installed in the instrument.

---

## In this chapter

This chapter contains the following sections:

Section	See page
2.1 Overview illustrations	14
2.2 Liquid flow path	25
2.3 Instrument control panel	27
2.4 Instrument modules	32
2.5 Installation of internal modules	76
2.6 Accessories	79

---

## 2.1 Overview illustrations

### Introduction

This section provides an overview of the system and its available modules.

### Core module configurations

ÄKTA pure is available with two core module configurations, one for flow rates up to 25 ml/min and one for flow rates up to 150 ml/min. In this manual they are referred to as ÄKTA pure 25 (25 ml/min) and ÄKTA pure 150 (150 ml/min).

### Illustrations of the main parts of the instrument

The illustrations below show the location of the main parts of the instrument.

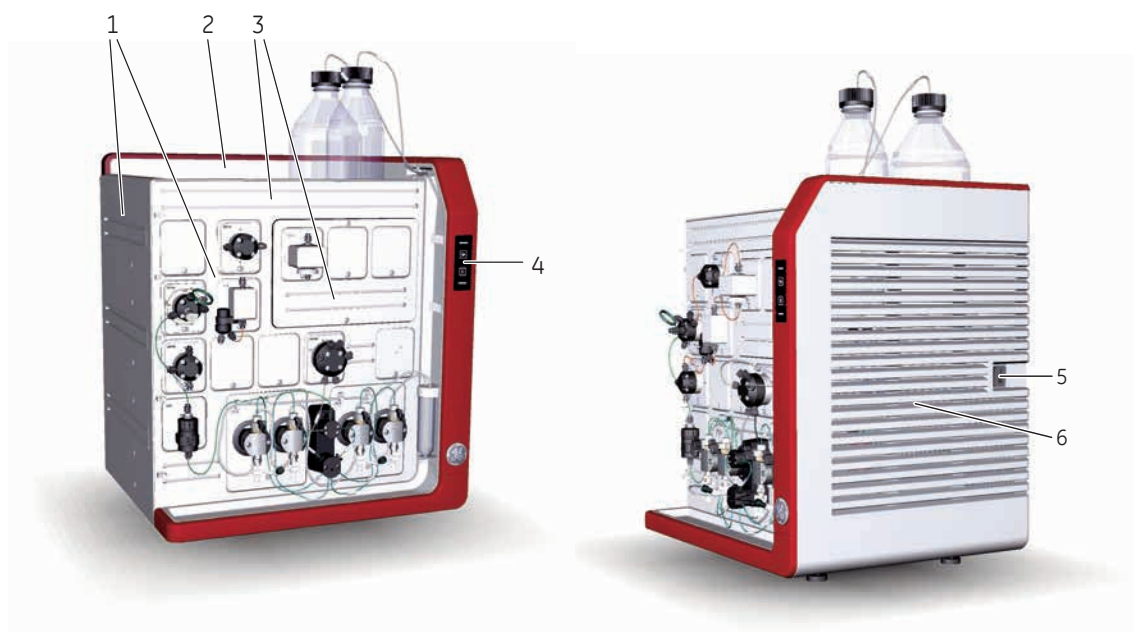

Part	Function
1	Wet sides
2	Buffer tray
3	Holder rails
4	Instrument control panel
5	Power switch
6	Ventilation panel

## Example of a typical configuration of the wet side

A typical configuration of ÄKTA pure is illustrated below.

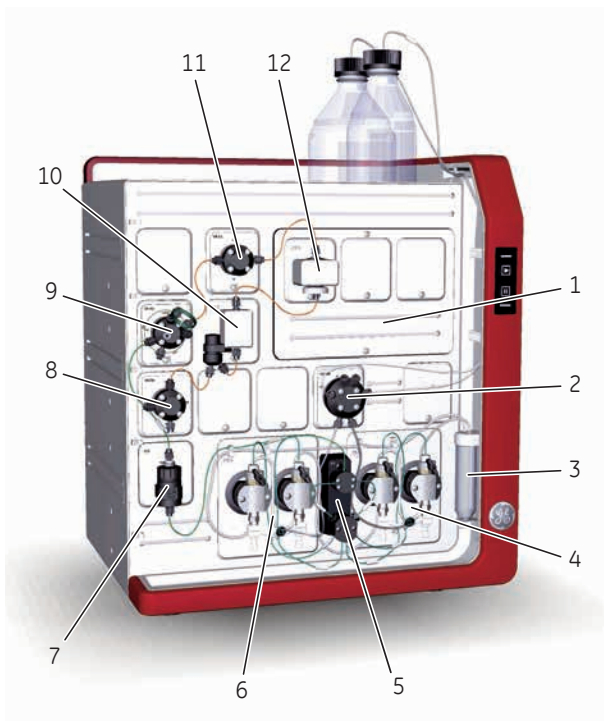

Part	Function
1	Multi-module panel
2	Inlet valve
3	Pump rinsing liquid tube
4	System pump B
5	Pressure monitor
6	System pump A
7	Mixer
8	Outlet valve
9	Injection valve
10	Conductivity monitor
11	Column valve
12	UV monitor

## Available modules

The modular design allows the user to customize ÄKTA pure in multiple ways. The system is always delivered with the core modules of the selected configuration, but optional modules may be added to the flow path.

The table below lists the available modules for ÄKTA pure 25 and ÄKTA pure 150. Core modules are indicated with an asterisk (\*).

**Note:** *The valves for ÄKTA pure 25 and ÄKTA pure 150 are compatible with both systems but for the best performance the specific valve type should be used. The narrow channels in the valves for ÄKTA pure 25 will give too high back pressure if used above 50 ml/min. The larger volumes in the "H" valves for ÄKTA pure 150 may decrease resolution and increase peak broadening if used in ÄKTA pure 25.*

Module	Label in	
	ÄKTA pure 25	ÄKTA pure 150
System pump A*	P9 A	P9H A
System pump B*	P9 B	P9H B
Pressure monitor*	R9	R9
Mixer*	M9	M9
Injection valve*	V9-Inj	V9H-Inj
Inlet valve A	V9-IA	V9H-IA
Inlet valve B	V9-IB	V9H-IB
Inlet valve AB	V9-IAB	V9H-IAB
Inlet valve IX	V9-IX	V9H-IX
Sample inlet valve	V9-IS	V9H-IS
Mixer valve	V9-M	V9H-M
Loop valve	V9-L	V9H-L
Column valves	V9-Cs	V9H-Cs
	V9-C	V9H-C
	V9-C2	V9H-C2
pH valve	V9-pH	V9H-pH
Outlet valves	V9-O	V9H-O
	V9-Os	V9H-Os
Versatile valve	V9-V	V9H-V



Module	Label in	
	ÄKTA pure 25	ÄKTA pure 150
UV monitors	U9-L	U9-L
	U9-M	U9-M
Conductivity monitor	C9	C9
External air sensor	L9-1.5	L9-1.5
	L9-1.2	L9-1.2
Fraction collectors	F9-C	F9-C
	F9-R	F9-R
I/O-box	E9	E9
Sample pump	S9	S9H

## Illustration convention

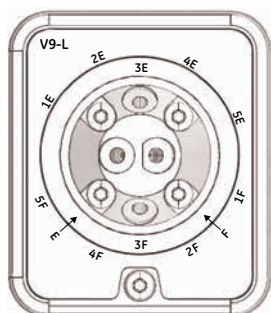

In the valve illustrations below, the following convention is used to point out the location of the ports on the valve head. Loop valve **V9-L** is used as an example.

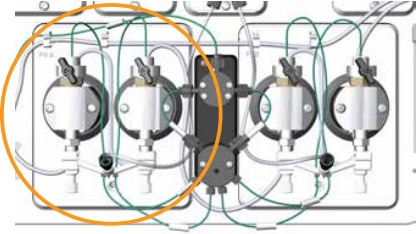

- Ports located on the valve head rim are indicated outside the black ring (e.g., 1E, 2E, etc.).
- Ports located on the pivot part of the valve head are indicated on the inside of the black ring (e.g., 3E and 3F).
- Ports located on the valve head front are indicated by an arrow (e.g., E and F).

## Core modules

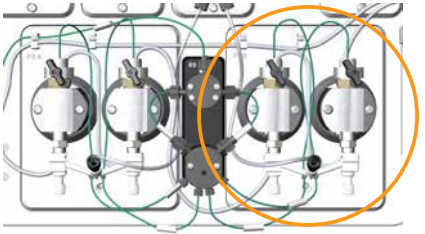
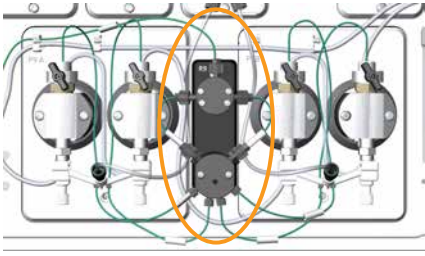
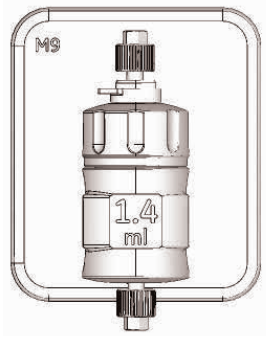
Core module	Description
System pump <b>P9 A</b> or <b>P9H A</b> 	A high precision pump, which delivers buffer or sample in purification runs. For further information, refer to <a href="#">Section 2.4.1 System pumps, on page 33</a> .

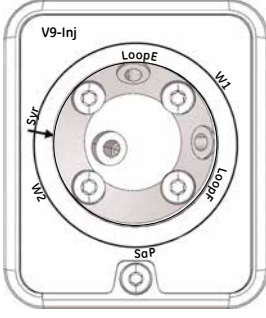
Core module	Description
<p>System pump <b>P9 B</b> or <b>P9H B</b></p> 	<p>A high precision pump, which delivers buffer in purification runs. For further information, refer to <a href="#">Section 2.4.1 System pumps, on page 33</a>.</p>
<p>Pressure monitor <b>R9</b></p> 	<p>Reads the system pressure after System pump A and System pump B. For further information, refer to <a href="#">Section 2.4.12 Pressure monitors, on page 67</a>.</p>
<p>Mixer <b>M9</b></p> 	<p>Mixes the buffers delivered from the system pumps to a homogeneous buffer composition.</p> <p>Three Mixer chambers are available for ÄKTA pure 25, their volumes are: 0.6 ml, 1.4 ml (mounted at delivery) and 5 ml.</p> <p>Three Mixer chambers are available for ÄKTA pure 150. Their volumes are: 1.4 ml (mounted at delivery), 5 ml (included in delivery), and 15 ml.</p> <div data-bbox="555 1221 1433 1434" style="border: 1px solid black; padding: 10px;">  <p><b>CAUTION</b> <b>Risk of explosion.</b> Do not use Mixer chamber 15 ml with an ÄKTA pure 25 system configuration. The maximum pressure for Mixer chamber 15 ml is 5 MPa.</p> </div> <p>For further information, refer to <a href="#">Section 2.4.2 Mixer, on page 37</a>.</p>
<p>Injection valve <b>V9-Inj</b> or <b>V9H-Inj</b></p> 	<p>Directs sample onto the column. For further information, refer to <a href="#">Section 2.4.6 Injection valve, on page 49</a>.</p>

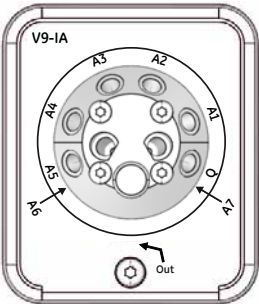
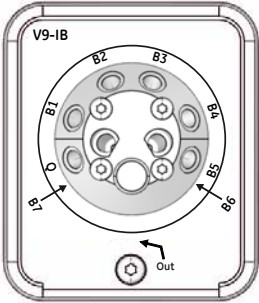
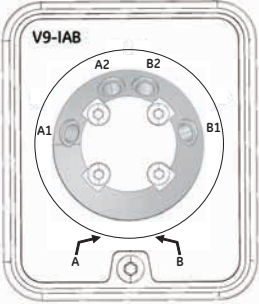
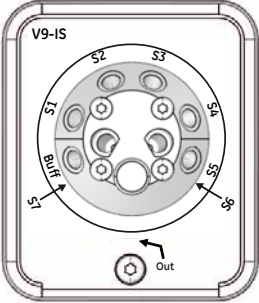

## Optional modules

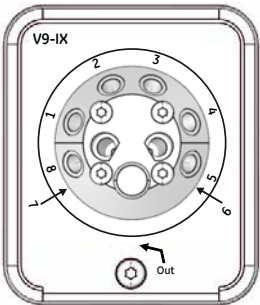
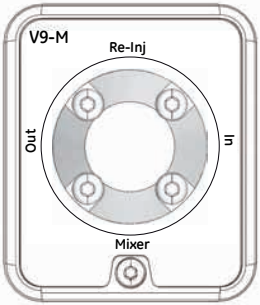
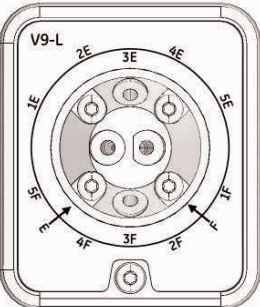
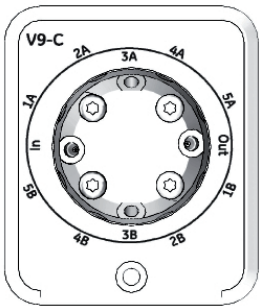
Module	Description
<p>Inlet valve <b>V9-IA</b> or <b>V9H-IA</b></p> 	<p>Inlet valve for System pump A with seven inlet ports and integrated air sensor. For further information, refer to <a href="#">Section 2.4.4 Inlet valves, on page 39</a>.</p>
<p>Inlet valve <b>V9-IB</b> or <b>V9H-IB</b></p> 	<p>Inlet valve for System pump B with seven inlet ports and integrated air sensor. For further information, refer to <a href="#">Section 2.4.4 Inlet valves, on page 39</a>.</p>
<p>Inlet valve <b>V9-IAB</b> or <b>V9H-IAB</b></p> 	<p>Inlet valve with two A inlet ports and two B inlet ports. No integrated air sensor. For further information, refer to <a href="#">Section 2.4.4 Inlet valves, on page 39</a>.</p>
<p>Sample inlet valve <b>V9-IS</b> or <b>V9H-IS</b></p> 	<p>Inlet valve with eight inlet ports (seven sample inlets and one buffer inlet) and integrated air sensor. The Sample inlet valve requires an external Sample pump module. For further information, refer to <a href="#">Section 2.4.4 Inlet valves, on page 39</a>.</p>

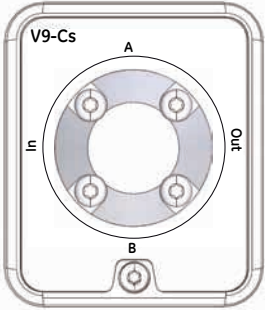
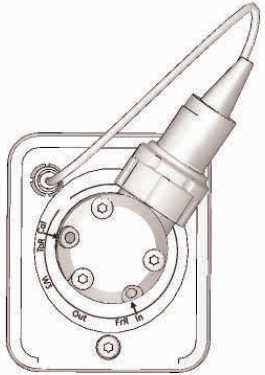
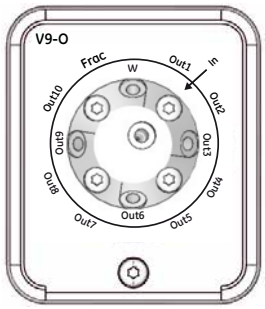
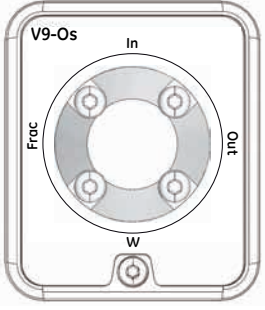
Module	Description
<p>Inlet valve <b>V9-IX</b> or <b>V9H-IX</b></p> 	<p>Inlet valve with eight inlet ports. No integrated air sensor.</p> <p>For further information, refer to <a href="#">Section 2.4.4 Inlet valves, on page 39</a>.</p>
<p>Mixer valve <b>V9-M</b> or <b>V9H-M</b></p> 	<p>Directs the flow to the Injection valve, bypassing the Mixer, or to the Injection valve via the Mixer.</p> <p>For further information, refer to <a href="#">Section 2.4.5 Mixer valve, on page 46</a>.</p>
<p>Loop valve <b>V9-L</b> or <b>V9H-L</b></p> 	<p>Enables the use of up to five loops connected to the instrument.</p> <p>For further information, refer to <a href="#">Section 2.4.7 Loop valve, on page 52</a>.</p>
<p>Column valve <b>V9-C</b> or <b>V9H-C</b> and <b>V9-C2</b> or <b>V9H-C2</b></p> 	<p><b>V9-C</b> or <b>V9H-C</b> can connect up to five columns to the instrument. Up to ten columns can be connected by installing the optional column valves <b>V9-C2</b> or <b>V9H-C2</b>.</p> <p>The column valves direct the flow to one column at a time and feature two integrated pressure sensors.</p> <p>The valves allow the user to choose flow direction through the column, or to bypass the column.</p> <p>For further information, refer to <a href="#">Section 2.4.8 Column valves, on page 55</a>.</p>

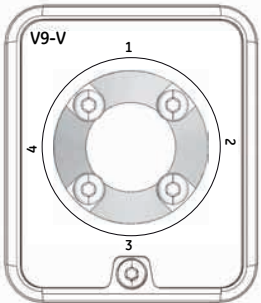
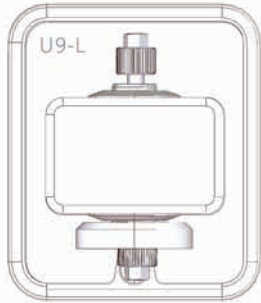
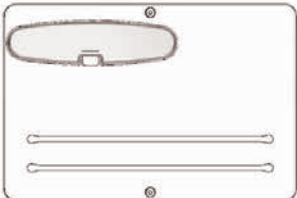
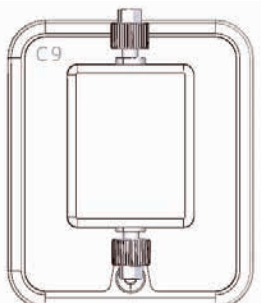
Module	Description
<p>Column valve <b>V9-Cs</b> or <b>V9H-Cs</b></p> 	<p>Connects a single column to the instrument.</p> <p>Allows the user to choose flow direction through the column, or to bypass the column.</p> <p>For further information, refer to <a href="#">Section 2.4.8 Column valves, on page 55</a>.</p>
<p>pH valve <b>V9-pH</b> or <b>V9H-pH</b></p> 	<p>Enables the pH electrode to be included in the flow path or bypassed during a run. The pH electrode may be calibrated when installed in the pH valve.</p> <p>For further information, refer to <a href="#">Section 2.4.10 pH valve, on page 60</a>.</p>
<p>Outlet valve <b>V9-O</b> or <b>V9H-O</b></p> 	<p>Directs the flow to the Fraction collector, Fraction collector 2 (out 10), any of the ten outlet ports, or waste.</p> <p>For further information, refer to <a href="#">Section 2.4.11 Outlet valves, on page 64</a>.</p>
<p>Outlet valve <b>V9-Os</b> or <b>V9H-Os</b></p> 	<p>Directs the flow to the Fraction collector, Fraction collector 2, the outlet port, or waste.</p> <p>For further information, refer to <a href="#">Section 2.4.11 Outlet valves, on page 64</a>.</p>

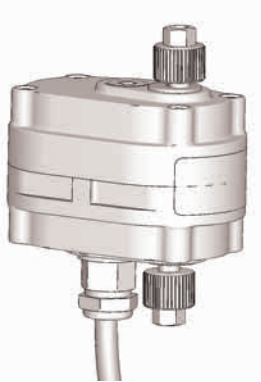
Module	Description
<p>Versatile valve <b>V9-V</b> or <b>V9H-V</b></p> 	<p>A 4-port, 4-position valve, which can be used when adding extra features to the flow path.</p> <p>For further information, refer to <a href="#">Section 2.4.9 Versatile valve, on page 59</a>.</p>
<p>UV monitor <b>U9-L</b></p> 	<p>Measures the UV absorbance at a fixed wavelength of 280 nm.</p> <p>For further information, refer to <a href="#">Section 2.4.13 UV monitors, on page 69</a>.</p>
<p>UV monitor <b>U9-M</b></p> 	<p>Measures the UV/Vis absorbance at up to three wavelengths simultaneously in the range 190-700 nm.</p> <p>For further information, refer to <a href="#">Section 2.4.13 UV monitors, on page 69</a>.</p>
<p>Conductivity monitor <b>C9</b></p> 	<p>Measures the conductivity of buffers and eluted proteins.</p> <p>For further information, refer to <a href="#">Section 2.4.14 Conductivity monitor, on page 72</a>.</p>

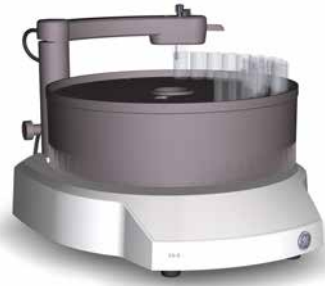
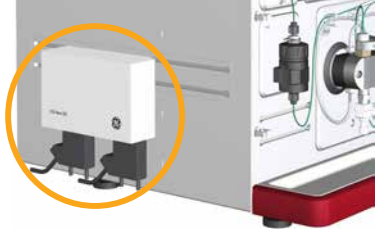
Module	Description
<p data-bbox="156 304 587 336">External air sensor <b>L9-1.5</b> or <b>L9-1.2</b></p> 	<p data-bbox="609 304 1500 385">Prevents air from being introduced into the flow path. For further information, refer to <a href="#">Section 3.1 External air sensors, on page 87</a>.</p>
<p data-bbox="156 768 432 800">Fraction collector <b>F9-C</b></p> 	<p data-bbox="609 768 1500 932">Flexible fraction collector that can collect up to 576 fractions. Up to two fraction collectors can be connected at the same time, of which only one (the primary) can be a Fraction collector F9-C. For further information, refer to <a href="#">Section 3.2 Fraction collector F9-C, on page 89</a>.</p>
<p data-bbox="156 1119 432 1151">Fraction collector <b>F9-R</b></p> 	<p data-bbox="609 1119 1437 1283">Round fraction collector that can collect up to 175 fractions. Up to two fraction collectors can be connected at the same time. For further information, refer to <a href="#">Section 3.3 Fraction collector F9-R, on page 103</a>.</p>
<p data-bbox="156 1506 288 1538">I/O-box <b>E9</b></p> 	<p data-bbox="609 1506 1500 1623">Receives analog or digital signals from, or transfers analog or digital signals to, external equipment that has been incorporated in the system. For further information, refer to <a href="#">Section 3.5 I/O-box E9, on page 111</a>.</p>

## 2 The ÄKTA pure instrument

### 2.1 Overview illustrations

Module	Description
<p data-bbox="97 306 384 336">Sample pump <b>S9</b> or <b>S9H</b></p> 	<p data-bbox="555 306 1398 374">A high precision pump with an integrated pressure monitor. The sample pump delivers buffer or sample in purification runs.</p> <p data-bbox="555 387 1410 455">For further information, refer to <a href="#">Section 3.4 Sample pump S9 and S9H, on page 107</a>.</p>



## 2.2 Liquid flow path

### Introduction

ÄKTA pure is a liquid chromatography system with a flexible flow path. This section provides an overview of the liquid flow path, and its possibilities.

### Example of a typical liquid flow path

The illustration below shows the flow path for a typical system configuration. The individual instrument modules are presented in the table below. The configuration of the system is defined by the user.

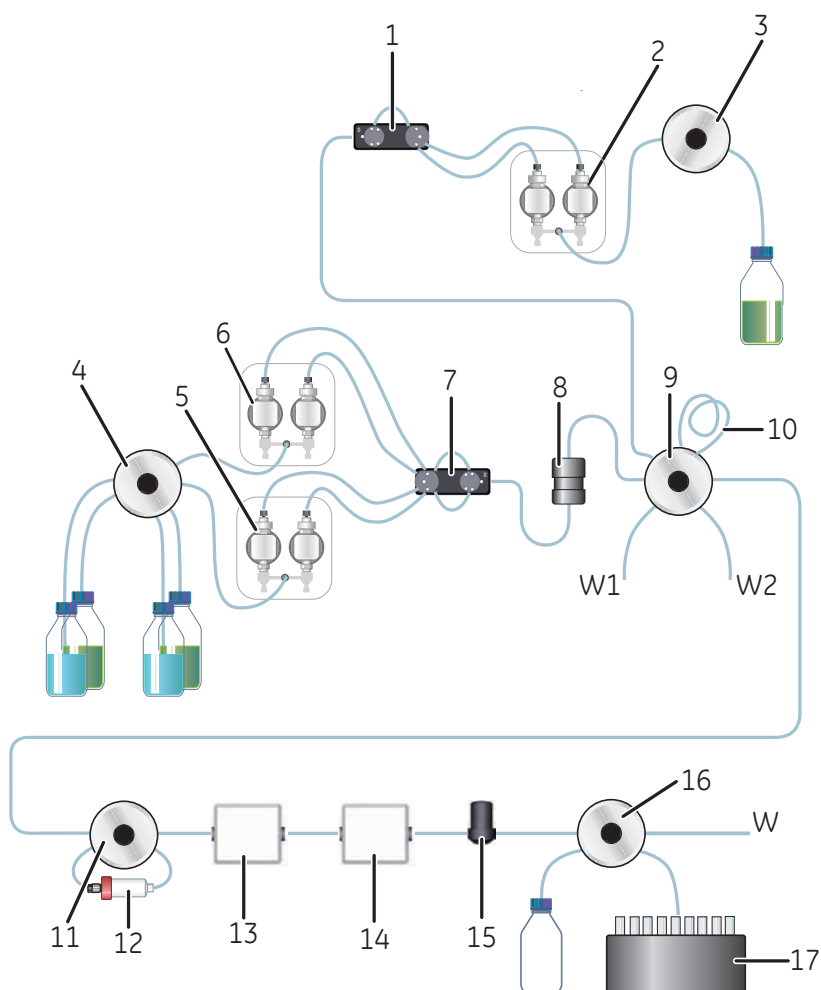

Part	Description
1	Pressure monitor
2	Sample pump
3	Sample inlet valve

## 2 The ÄKTA pure instrument

### 2.2 Liquid flow path

Part	Description
4	Inlet valve
5	System pump B
6	System pump A
7	Pressure monitor
8	Mixer
9	Injection valve
10	Sample loop or Superloop
11	Column valve
12	Column
13	UV monitor
14	Conductivity monitor
15	Flow restrictor
16	Outlet valve
17	Fraction collector
W, W1, W2	Waste

## 2.3 Instrument control panel

### Introduction

This section describes the design and main function of the Instrument control panel **B9**.

### Function of the Instrument control panel

The Instrument control panel shows the current state of the system. The **Pause** and **Continue** buttons can be used to control an ongoing run. It is possible to lock and unlock the Instrument control buttons from UNICORN.

### Location and illustration

The illustration below shows the location and detailed view of the Instrument control panel.

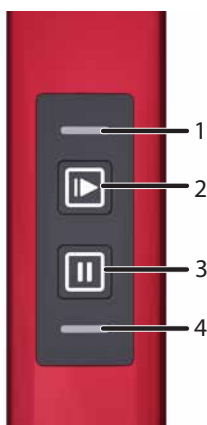
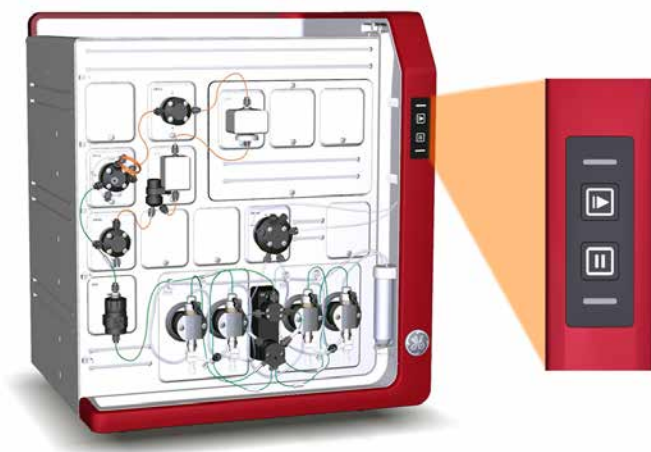

Part	Function
1	<b>Power/Communication</b> indicator (white)
2	<b>Continue</b> button with a green light indicator
3	<b>Pause</b> button with an orange light indicator
4	<b>Alarm and error</b> indicator (red)

## Lock/Unlock function

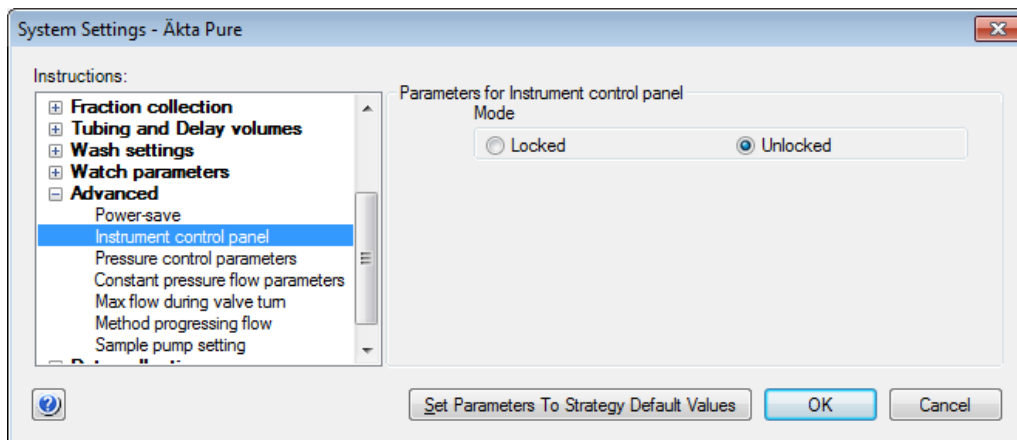

Follow the instruction below to lock or unlock the **Pause** and **Continue** buttons of the Instrument control panel from UNICORN.

- | Step | Action   |
|------|--|
| 1    | In <b>System Control</b> , select <b>System:Settings</b> .<br><i>Result:</i> The <b>System Settings</b> dialog opens.  |
| 2    | In the <b>System Settings</b> dialog: <ul style="list-style-type: none"><li>• Select <b>Advanced:Instrument control panel</b>.</li><li>• Select <b>Locked</b> or <b>Unlocked</b>.</li><li>• Click <b>OK</b>.</li></ul> |







## Buttons





The Instrument control panel includes the following buttons:



Part	Function
	Resumes instrument operation from the following states: <ul style="list-style-type: none"><li>• <b>Pause</b></li><li>• <b>Wash</b></li><li>• <b>Hold</b></li></ul>
	Pauses the run and stops all pumps.

## Status indications

The light indicators on the Instrument control panel indicate the current status of ÄKTA pure. The table below describes the different states that can be displayed.

Display	State	Description
<p>All light indicators are off.</p> 	<b>Off</b>	The instrument is turned off.
<p>The <b>Power/Communication</b> indicator flashes slowly.</p> 	<b>Power-on</b>	The instrument has no communication with the Instrument server.
<p>The <b>Power/Communication</b> indicator flashes quickly.</p> 	<b>Connecting</b>	The system is starting up.
<p>The <b>Power/Communication</b> indicator displays a constant light.</p> 	<b>Ready</b>	The instrument is ready to use.

Display	State	Description
<p>Both the <b>Power/Communication</b> indicator and <b>Continue</b> button display a constant light.</p> 	<b>Run</b>	A run is ongoing.
<p>The <b>Power/Communication</b> indicator displays a constant light and the <b>Continue</b> button flashes slowly.</p> 	<b>Wash</b>	A wash instruction or a pump synchronization is ongoing.
	<b>Hold</b>	A run has been put on hold.
<p>Both the <b>Power/Communication</b> indicator and <b>Pause</b> button display a constant light.</p> 	<b>Pause</b>	A run has been paused.
<p>The <b>Power/Communication</b> indicator displays a constant light. and the <b>Alarm and error</b> indicator flashes.</p> 	<b>Alarms and errors</b>	The system has been paused due to an alarm. To resume the run, acknowledge the alarm and continue the run in UNICORN.

Display	State	Description
<p>The <b>Power/Communication</b> indicator displays a pulsating light.</p> 	<p><b>Power-save</b></p>	<p>The system is in power-saving mode.</p>
<p>All indicators are lit in a wave pattern.</p> 	<p><b>Re-programming</b></p>	<p>A module is being re-programmed to be compatible with the current instrument configuration.</p>

## 2.4 Instrument modules

### Introduction

This section describes the design and main functions of the instrument modules.

---

### In this section

This section contains the following subsections:

Section	See page
2.4.1 System pumps	33
2.4.2 Mixer	37
2.4.3 Valves, overview	38
2.4.4 Inlet valves	39
2.4.5 Mixer valve	46
2.4.6 Injection valve	49
2.4.7 Loop valve	52
2.4.8 Column valves	55
2.4.9 Versatile valve	59
2.4.10 pH valve	60
2.4.11 Outlet valves	64
2.4.12 Pressure monitors	67
2.4.13 UV monitors	69
2.4.14 Conductivity monitor	72
2.4.15 Flow restrictor	74

---



## 2.4.1 System pumps

### Introduction

This section describes the design and main functions of the system pumps, and also the pump piston rinsing systems. The system can also be equipped with an external, optional sample pump, see [Section 3.4 Sample pump S9 and S9H, on page 107](#).

### Function of the system pumps

The ÄKTA pure instrument is fitted with two high precision system pumps, System pump A and System pump B. The system pumps can be used individually, or in combination to generate isocratic or gradient elution in purification methods.

Each pump module consists of two pump heads that work alternately to give a continuous, low pulsation, liquid delivery. To ensure delivery of correct liquid volume, the pumps must be free from air. Each pump head is equipped with a purge valve that is used for this purpose. See [Section 5.4 Prime inlets and purge pump heads, on page 160](#).

The table below contains the operating limits and labels of the system pumps of ÄKTA pure 25 and ÄKTA pure 150, respectively.

Configuration	Label	Pump type	Flow rate	Max. pressure
ÄKTA pure 25	<b>P9 A and P9 B</b>	P9	0.001 – 25 ml/min  <b>Note:</b> <i>When running the <b>Column packing flow</b> instruction, the maximum flow rate is 50 ml/min.</i>	20 MPa
ÄKTA pure 150	<b>P9H A and P9H B</b>	P9H	0.01 – 150 ml/min  <b>Note:</b> <i>When running the <b>Column packing flow</b> instruction, the maximum flow rate is 300 ml/min.</i>	5 MPa

## Location and illustration

The illustration below shows the location of System pump A and System pump B, together with a detailed view of a system pump.

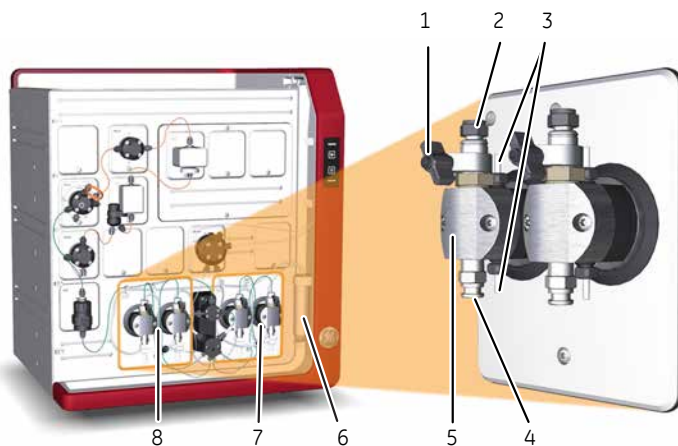

Part	Description
1	Purge valve: Used to remove air from the pump
2	Outlet port with check valve
3	Connections to pump piston rinsing system: Tubing is connected between the pumps and the Pump piston rinsing system tube (6)
4	Inlet port with check valve
5	Pump head: Encapsulates the inner parts of the pump
6	Pump piston rinsing system tube
7	System pump B
8	System pump A

## The pump piston rinsing system

A seal prevents leakage between the pump chamber and the drive mechanism. The seal is continuously lubricated by the presence of liquid. The pump piston rinsing system continuously flushes the low pressure chamber behind the piston with a low flow of 20% ethanol. This prevents any deposition of salts from aqueous buffers on the pistons and prolongs the working life of the seals.

The pump piston rinsing system tubing is connected to the rearmost holes on the pump heads.

For instructions on how to fill the rinsing system, see [Prime the system pump piston rinsing system, on page 263](#).

## Illustration of the pump piston rinsing system

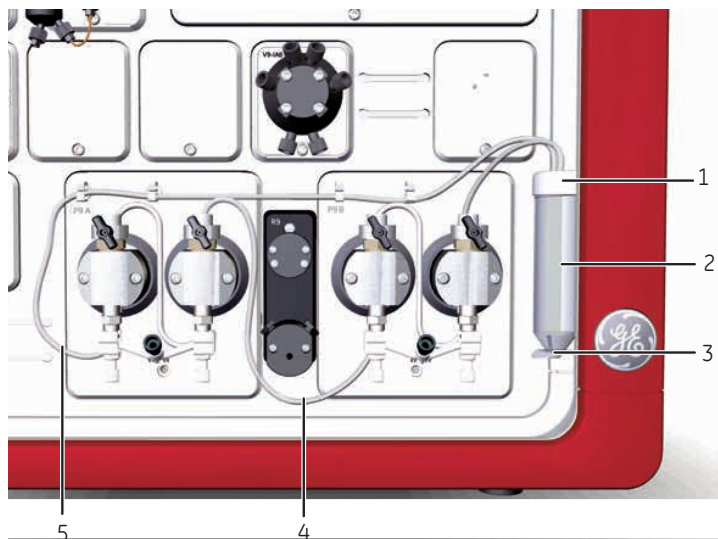

Part	Description
1	Rinsing system tube holder, top
2	Rinsing system tube
3	Rinsing system tube holder, bottom
4	Outlet tubing
5	Inlet tubing

## System pump rinsing systems flow path

The illustration below shows the tubing configuration of the pump piston rinsing system of the system pumps.

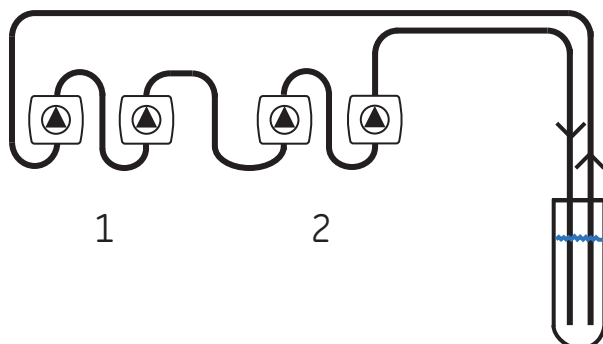

## 2 The ÄKTA pure instrument

### 2.4 Instrument modules

#### 2.4.1 System pumps

Part	Description
1	System pump A
2	System pump B

## 2.4.2 Mixer

### Function of the Mixer

Mixer **M9** is located after System pump A and System pump B, and before the Injection valve. The Mixer is a dynamic mixer for high-performance gradients. It is used to make sure that the buffers from the System pumps are mixed to give a homogenous buffer composition.

The Mixer has a built-in filter that prevents particles from reaching the column.

**Note:** Replace the sealing ring of the mixer with a highly resistant O-ring if the system is going to be exposed to organic solvents or high concentrations of organic acids for longer periods of time. Refer to [Section 7.8.4 Replace the O-ring inside the Mixer, on page 323](#) for how to change the ring.

### Location and illustration

The illustration below shows the location, together with a detailed view of Mixer **M9**.



Part	Description
1	Outlet
2	Mixer chamber (0.6, 1.4, 5 or 15 ml)  <div style="border: 1px solid black; padding: 5px;">  <p><b>CAUTION</b>  <b>Risk of explosion.</b> Do not use Mixer chamber 15 ml with an ÄKTA pure 25 configuration. The maximum pressure for Mixer chamber 15 ml is 5 MPa.</p> </div>
3	Inlet

## 2.4.3 Valves, overview

### General design and function of rotary valves

The valves of the ÄKTA pure instrument allow flexibility in the liquid flow path.

All valves used in the ÄKTA pure instrument are rotary valves. The motorized rotary valve consists of a Valve connection block with a number of defined bores with channels to the inlet and outlet ports of the valve. The Rotary disc, mounted on the motor, has a number of defined channels. The pattern of channels of the Rotary disc together with the pattern and location of the ports of the Valve connection block, define the flow path and function of each type of valve. When the Rotary disc turns, the flow path in the valve changes.

### Illustration of inlet valve components

The illustration below shows the components of a disassembled Inlet valve A or a disassembled Inlet valve B.

Inlet valve AB is built up by the same parts but have another configuration of defined bores.

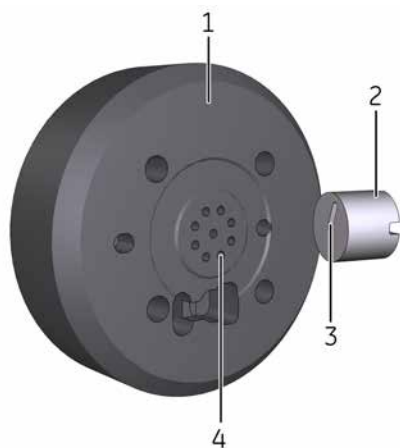

Part	Description
1	Valve connection block (stator)
2	Rotary disc (rotor)
3	Defined channel(s) in the Rotary disc
4	Defined bores in the Valve connection block

**Note:** Inlet and outlet ports are not visible in the picture. They are located on the opposite side of the Valve connection block.

## 2.4.4 Inlet valves

### Function of the inlet valves

The inlet valves are used to select which buffers or samples to use in a run. The inlet valves available for ÄKTA pure and their functions are described in the table below.

Inlet valve	Label in		Function
	ÄKTA pure 25	ÄKTA pure 150	
Inlet valve A	<b>V9-IA</b>	<b>V9H-IA</b>	Enables automatic change between different buffers and wash solutions (seven inlet ports). Can be used together with Inlet valve B to generate gradients by mixing buffer from System pump A and buffer from System pump B.
Inlet valve B	<b>V9-IB</b>	<b>V9H-IB</b>	Enables automatic change between different buffers and wash solutions (seven inlet ports). Can be used together with Inlet valve A to generate gradients by mixing buffer from System pump A and buffer from System pump B.
Inlet valve AB	<b>V9-IAB</b>	<b>V9H-IAB</b>	Enables automatic change between different buffers and wash solutions (two A and two B inlet ports). Can be used to generate gradients by mixing buffer from System pump A and buffer from System pump B.
Sample inlet valve	<b>V9-IS</b>	<b>V9H-IS</b>	Enables automatic loading of up to seven samples when used together with a sample pump.
Inlet valve X	<b>V9-IX</b>	<b>V9H-IX</b>	Increases the total number of inlets to the system. Can be used in two different configurations X1 and X2. The configurations are called <b>V9-X1</b> and <b>V9-X2</b> for ÄKTA pure 25 and, <b>V9H-X1</b> and <b>V9H-X2</b> for ÄKTA pure 150.

The modular design of ÄKTA pure allows the use of several combinations of inlet valves.

The possible combinations of Inlet valve A, Inlet valve B and Inlet valve AB are:

- one Inlet valve A
- one Inlet valve B
- Inlet valve A and Inlet valve B,
- Inlet valve AB together with Inlet valve A or Inlet valve B,
- one Inlet valve AB,

or

## 2 The ÄKTA pure instrument

### 2.4 Instrument modules

#### 2.4.4 Inlet valves

- no installed inlet valves.

The sample inlet valve can be used together with any of the combinations listed above.

The air sensors integrated in Inlet valve A, Inlet valve B, and Sample inlet valve detect the presence of air and prevent the air from entering the pump.

Inlet valve AB and Inlet valve IX lack built-in air sensors, but can be used together with external air sensors.

### Location of inlet valves

The locations of the inlet valves are described in the following table:

Inlet valve	Location
Inlet valve A	Before System pump A
Inlet valve B	Before System pump B
Inlet valve AB	Before both System pump A and System pump B
Sample inlet valve	Before the sample pump
Inlet valve IX	For example, before another inlet valve

### Illustration of Inlet valve A and Inlet valve B

The illustration below shows a detailed view of Inlet valve A and Inlet valve B, in this example with labels **V9-IA** and **V9-IB**.

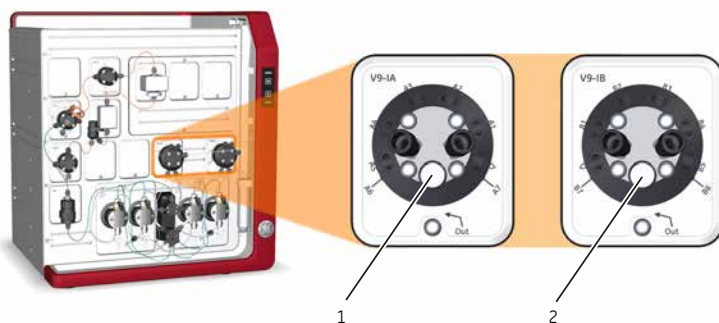

Part	Description
1	Integrated air sensor of Inlet valve A (located under the plug)
2	Integrated air sensor of Inlet valve B (located under the plug)



## Ports of Inlet valve A and Inlet valve B

The illustration below shows the ports of Inlet valve A and Inlet valve B, in this example with labels **V9-IA** and **V9-IB**.

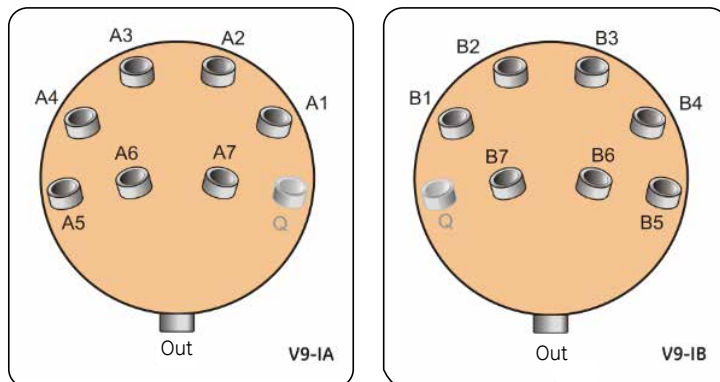

Port	Description
<b>A1-A7</b>	Buffer inlets of Inlet valve A
<b>B1-B7</b>	Buffer inlets of Inlet valve B
<b>Q</b>	Not used for ÄKTA pure
<b>Out</b>	To the respective System pump

## Illustration of Inlet valve AB

The illustration below shows a detailed view of Inlet valve AB.

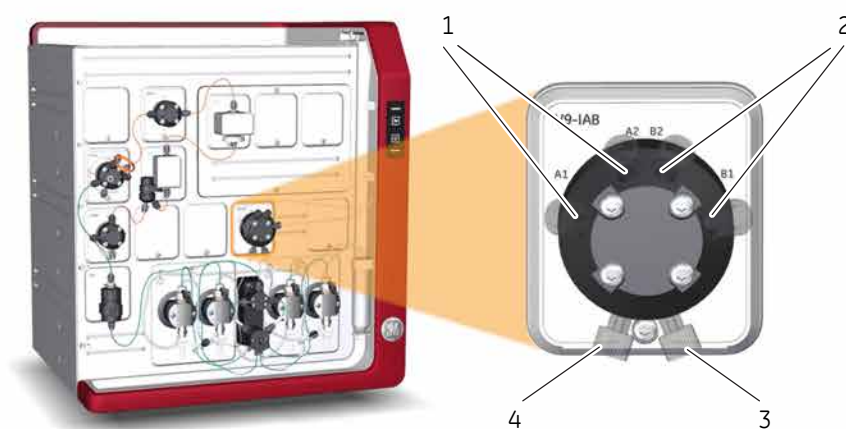

Part	Description
1	A inlet ports
2	B inlet ports
3	Outlet port to System pump B
4	Outlet port to System pump A

**Note:** *Inlet valve AB does not have any integrated air sensor.*

## Ports of Inlet valve AB

The illustration below shows the ports of Inlet valve AB.

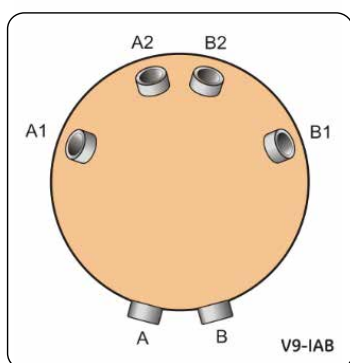

Port	Description
<b>A1-A2</b>	Inlet ports <b>A1</b> and <b>A2</b> of Inlet valve AB are used when buffers or samples should be delivered to System pump A
<b>B1-B2</b>	Inlet ports <b>B1</b> and <b>B2</b> of Inlet valve AB are used when buffers or samples should be delivered to System pump B
<b>A</b>	Outlet port <b>A</b> of Inlet valve AB leads to System pump A
<b>B</b>	Outlet port <b>B</b> of Inlet valve AB leads to System pump B

## Illustration of Sample inlet valve

The illustration below shows a detailed view of the Sample inlet valve.

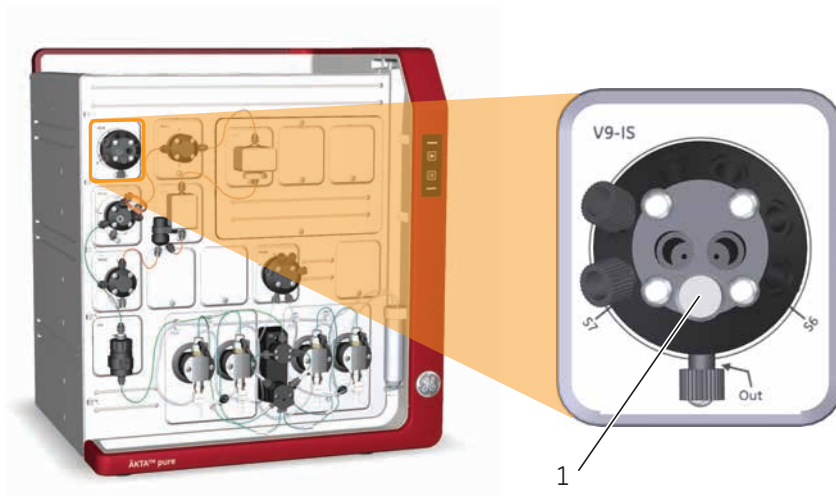

Part	Description
1	Integrated air sensor (located under the plug)

## Ports of Sample inlet valve

The illustration below shows the ports of Sample inlet valve, in this example labeled **V9-IS**.

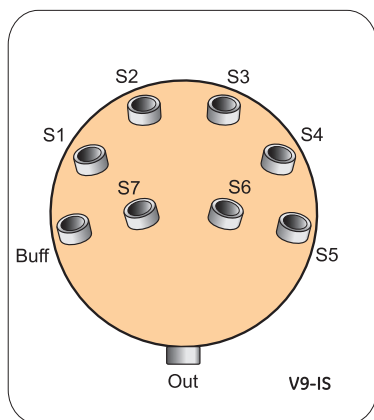

Port	Description
<b>S1-S7</b>	Sample inlets
<b>Buff</b>	Buffer inlet
<b>Out</b>	To Sample pump

## Ports of Inlet valve IX

The illustration below shows the ports of Inlet valve IX.

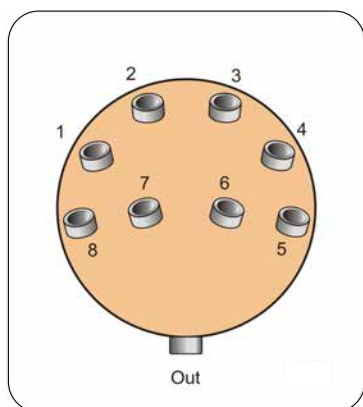

Port	Description
1-8	Inlets
Out	For example, to another inlet valve

**Note:** Inlet valve IX does not have an integrated air sensor.

## Connect tubing

The table below shows the tubing and connectors that is delivered together with the optional inlet valves.

Tubing label	Connection	Tubing		Connector		Tubing length (mm)
		ÄKTA pure 25	ÄKTA pure 150	ÄKTA pure 25	ÄKTA pure 150	
<b>A1-A2</b> and <b>B1-B2</b>	Inlets to Inlet valve AB	FEP, o.d. 1/8", i.d. 1.6 mm	FEP, o.d. 3/16", i.d. 2.9 mm	Tubing connector, 5/16" with Ferrule (yellow), 1/8"	Tubing connector, 5/16" with Ferrule (blue), 3/16"	1500
<b>A1-A7</b>	Inlets to Inlet valve A	FEP, o.d. 1/8", i.d. 1.6 mm	FEP, o.d. 3/16", i.d. 2.9 mm	Tubing connector, 5/16" with Ferrule (yellow), 1/8"	Tubing connector, 5/16" with Ferrule (blue), 3/16"	1500
<b>B1-B7</b>	Inlets to Inlet valve B	FEP, o.d. 1/8", i.d. 1.6 mm	FEP, o.d. 3/16", i.d. 2.9 mm	Tubing connector, 5/16" with Ferrule (yellow), 1/8"	Tubing connector, 5/16" with Ferrule (blue), 3/16"	1500

Tubing label	Connection	Tubing		Connector		Tubing length (mm)
		ÄKTA pure 25	ÄKTA pure 150	ÄKTA pure 25	ÄKTA pure 150	
<b>InA</b>	From Inlet valve A or Inlet valve AB to System pump A	FEP, o.d. 1/8", i.d. 1.6 mm	FEP, o.d. 3/16", i.d. 2.9 mm	Tubing connector, 5/16" with Ferrule (yellow), 1/8"	Tubing connector, 5/16" with Ferrule (blue), 3/16"	300
<b>InB</b>	From Inlet valve B or Inlet valve AB to System pump B	FEP, o.d. 1/8", i.d. 1.6 mm	FEP, o.d. 3/16", i.d. 2.9 mm	Tubing connector, 5/16" with Ferrule (yellow), 1/8"	Tubing connector, 5/16" with Ferrule (blue), 3/16"	300
<b>S1-S7</b>	Sample inlets to Sample inlet valve	FEP o.d. 1/8", i.d. 1.6 mm	FEP, o.d. 3/16", i.d. 2.9 mm	Tubing connector, 5/16" with Ferrule (yellow), 1/8"	Tubing connector, 5/16" with Ferrule (blue), 3/16"	1000
<b>Buff</b>	Buffer inlet to Sample inlet valve	FEP o.d. 1/8", i.d. 1.6 mm	FEP, o.d. 3/16", i.d. 2.9 mm	Tubing connector, 5/16" with Ferrule (yellow), 1/8"	Tubing connector, 5/16" with Ferrule (blue), 3/16"	1000
<b>InS</b>	Sample inlet valve to Sample Pump	FEP o.d. 1/8", i.d. 1.6 mm	FEP, o.d. 3/16", i.d. 2.9 mm	Tubing connector, 5/16" with Ferrule (yellow), 1/8"	Tubing connector, 5/16" with Ferrule (blue), 3/16"	580

**Note:** Narrow inlet tubing is available for **S1-S7**. Refer to [Section 9.3 Tubing and connectors](#), on [page 420](#) for more information.

## 2.4.5 Mixer valve

### Function of Mixer valve

Mixer valve (**V9-M** or **V9H-M**) allows the user to bypass the mixer. It is intended to be used when the System pump is used for sample application or when a sample is re-injected.

**Note:** Mixer valve (**V9-M** or **V9H-M**) cannot be used together with Sample pump **S9** or Sample pump **S9H**.

---

### Location and illustration of Mixer valve

The illustration below shows the recommended location, together with a detailed view of the Mixer valve.



### Ports and flow paths of the mixer valve

The illustration and tables below describe the ports of and different flow paths through the Mixer valve. The Mixer valve has two available flow paths; **By-pass**, and **Mixer** (default). If the Mixer valve is installed in the recommended location before the Mixer, **By-pass** allows the flow to bypass the Mixer, and **Mixer** directs the flow to the Mixer.

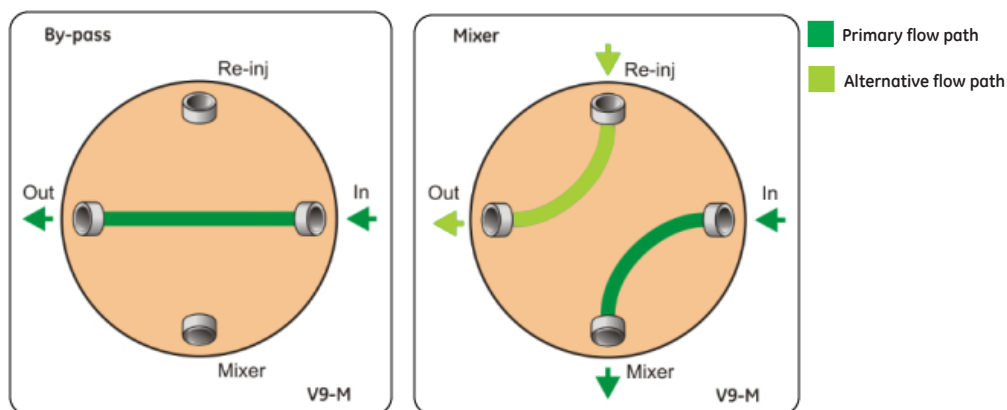

Port	Description
<b>In</b>	Port in which the flow enters the valve. Should be connected to the System pressure monitor outlet.
<b>Out</b>	Port from which the flow leaves the Mixer valve and bypasses the Mixer. Connect to the injection valve <b>SaP</b> port.
<b>Re-inj</b>	Port for advanced configurations including re-injection.
<b>Mixer</b>	Port from which the flow leaves the valve and is directed to the Mixer.

## Connect tubing

The table below shows recommended tubing and connectors.

Tubing label	Connection	Tubing		Connector	Tubing length (mm)
		ÄKTA pure 25	ÄKTA pure 150		
<b>3-1</b>	Pressure monitor R9 to Mixer valve V9-M port <b>In</b>	PEEK, o.d. 1/16", i.d. 0.75 mm	PEEK, o.d. 1/16", i.d. 1.00 mm	Fingertight connector, 1/16"	160
<b>3-2</b>	Mixer valve V9-M port <b>Mixer</b> to Mixer M9	PEEK, o.d. 1/16", i.d. 0.75 mm	PEEK, o.d. 1/16", i.d. 1.00 mm	Fingertight connector, 1/16"	330
<b>3-3</b>	Mixer valve V9-M port <b>Out</b> to Injection valve V9-Inj port <b>SaP</b>	PEEK, o.d. 1/16", i.d. 0.75 mm	PEEK, o.d. 1/16", i.d. 1.00 mm	Fingertight connector, 1/16"	260

## Flow paths through Mixer valve

The Mixer valve (V9-M, V9H-M) has two available flow paths; **By-pass**, and **Mixer**. If the Mixer valve is installed in the recommended location before the Mixer, **By-pass** allows the flow to bypass the Mixer, and **Mixer** directs the flow to the Mixer.

The illustration below shows the different flow paths through the Mixer valve **V9-M**.

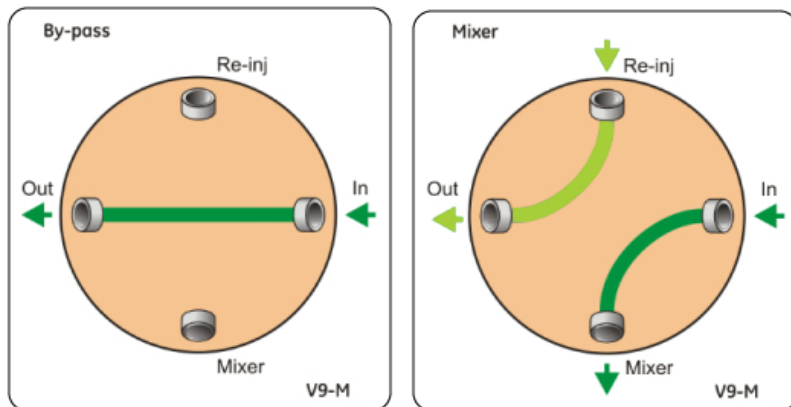

- Primary flow path
- Alternative flow path

Flow path	Description
<b>By-pass</b>	The flow from the system pumps bypasses the mixer.
<b>Mixer</b>	The flow from the system pumps is directed to the Mixer. <b>Mixer</b> is the default flow path.



## 2.4.6 Injection valve

### Function of the Injection valve

The Injection valve is used to direct sample onto the column. The valve enables usage of a number of different sample application techniques.

The injection valve is labeled **V9-Inj** for ÄKTA pure 25 and **V9H-Inj** for ÄKTA pure 150.

A sample loop or a Superloop can be connected to the injection valve and filled either automatically, using a Sample Pump or System pump A, or manually, using a syringe. The sample can also be injected directly onto the column using a Sample pump, or System pump A together with the mixer valve.

For instructions on how to connect and use loops, see [Section 5.7 Sample application, on page 179](#).

### Location and illustration of the Injection valve

The illustration below shows the location, together with a detailed view of the Injection valve, in this example labeled **V9-Inj**.



### Ports and flow paths of the Injection valve

The illustration and tables below describe the ports of and different flow paths through the Injection valve.

The Injection valve can be set to different positions that give different flow paths through the valve.

## 2 The ÄKTA pure instrument

### 2.4 Instrument modules

#### 2.4.6 Injection valve

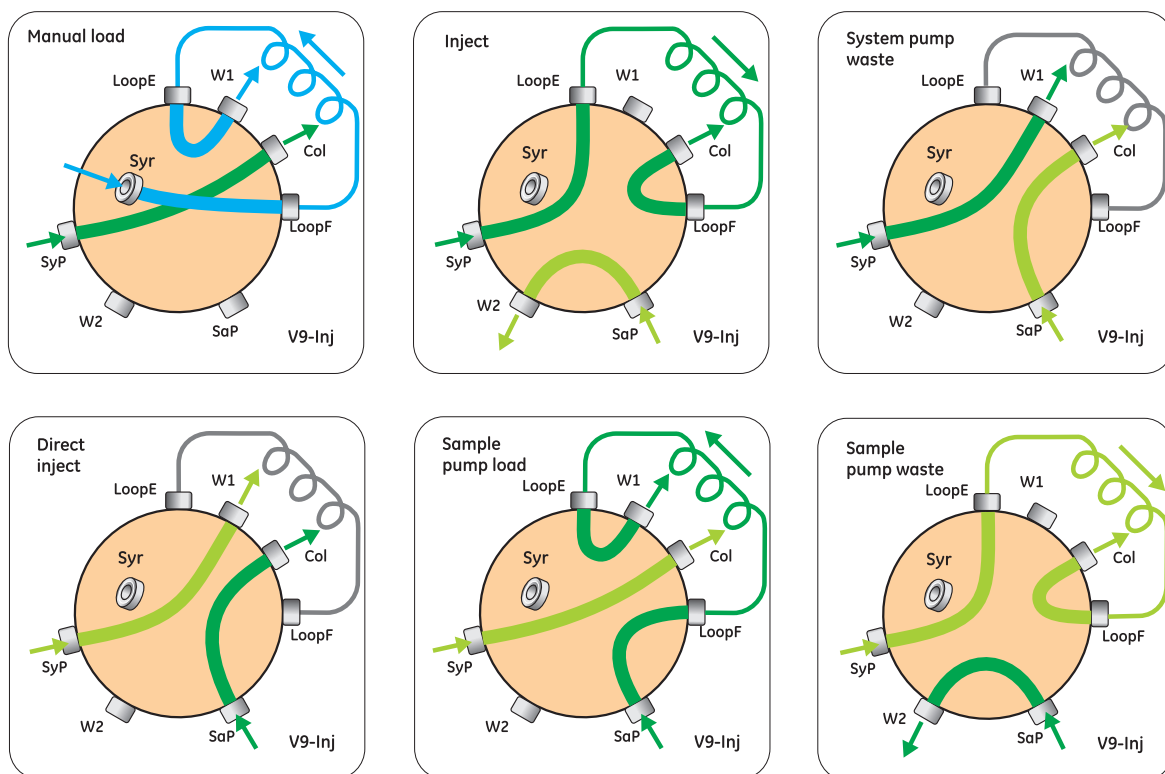

- Primary flow path
- Alternative flow path
- Flow path for manual load
- Closed flow path

Port	Description
<b>SaP</b>	Inlet from <ul style="list-style-type: none"> <li>sample pump, or</li> <li>system pump via the Mixer valve <b>Out</b> port.</li> </ul>
<b>SyP</b>	Inlet from the System pumps via the Mixer
<b>Syr</b>	Syringe connection
<b>Col</b>	Outlet to one of the Column valves or to the column.
<b>LoopF</b>	Port for connection of a loop. Used to fill the loop.
<b>LoopE</b>	Port for connection of a loop. Used to empty the loop into the flow path.
<b>W1</b>	Loop and System pump waste
<b>W2</b>	Sample flow waste

Flow path	Description
<b>Manual load</b> - Default position of the valve	The system flow is directed onto the column or column valve. Sample can be manually injected into the loop. Excess sample leaves the valve through waste port <b>W1</b> .
<b>Inject</b>	The system flow is directed through the loop and onto the column or column valve. If a mixer valve or the sample pump is used, the flow entering the <b>SaP</b> port is directed to waste port <b>W2</b> .
<b>System pump waste</b>	The system flow is directed to waste port <b>W1</b> . If a mixer valve or the sample pump is used, the flow entering the <b>SaP</b> port is directed to the column or the column valve.
<b>Direct inject</b>	The flow entering the <b>SaP</b> port is directed to the column or the column valve. This position is used with: <ul style="list-style-type: none"> <li>• the sample pump, or</li> <li>• a mixer valve and System pump A, bypassing the mixer.</li> </ul> Flow entering the <b>SyP</b> port is directed to waste port <b>W1</b> .
<b>Sample pump load</b>	The flow entering the <b>SaP</b> port is directed to the loop. This position is used with: <ul style="list-style-type: none"> <li>• the sample pump, or</li> <li>• a mixer valve and System pump A, bypassing the mixer.</li> </ul> Excess sample leaves the valve through waste port <b>W1</b> . The flow entering the <b>SyP</b> port is directed to the column or the column valve.
<b>Sample pump waste</b>	The flow entering the <b>SaP</b> port is directed to waste port <b>W2</b> . This position is used with: <ul style="list-style-type: none"> <li>• the sample pump, or</li> <li>• a mixer valve and System pump A.</li> </ul> The flow entering the <b>SyP</b> port is directed to the column via the loop.

- Note:**
- *In order to avoid sample carry-over when switching techniques for loading samples, wash the injection valve with buffer between the loading of two different samples. For example, when switching from loading sample onto the loop to loading sample directly onto the column with the valve in **Direct inject** position.*
  - *Make sure that the **SaP** port is plugged with a stop plug if neither the sample pump nor the mixer is used.*

## 2.4.7 Loop valve

### Function of the Loop valve

The Loop valve allows the user to connect several loops simultaneously to the instrument. It can for example be used for storing intermediate fractions in multi-step purifications, for storing samples to be used in scouting runs, or for storing eluents needed in low volumes. The valve also has a built-in bypass function that enables bypassing all loops. The Loop valve is labeled **V9-L** or **V9H-L**.

### Location and illustration of Loop valve

The illustration below shows the recommended location, together with a detailed view of Loop valve **V9-L**.



### Ports and flow paths of the Loop valve

The illustration and tables below describe the ports and different flow paths through the Loop valve.

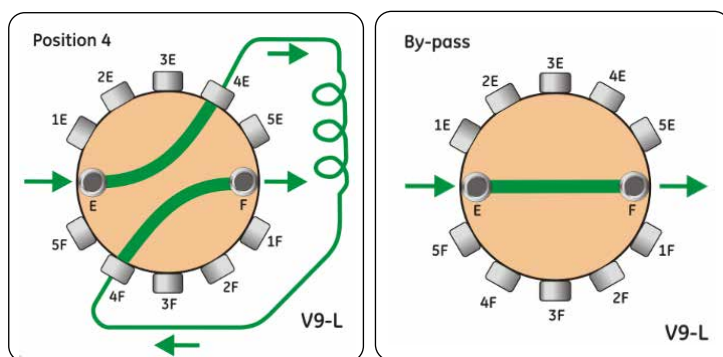

In the **Position 4** example, the loop is connected to loop position 4 and the loop is being emptied.

Port	Description
<b>F</b>	Port connected to the <b>LoopF</b> port of the Injection valve.
<b>1F</b> and <b>1E</b>	Ports for connection to loop 1.
<b>2F</b> and <b>2E</b>	Ports for connection to loop 2.
<b>3F</b> and <b>3E</b>	Ports for connection to loop 3.
<b>4F</b> and <b>4E</b>	Ports for connection to loop 4.
<b>5F</b> and <b>5E</b>	Ports for connection to loop 5.
<b>E</b>	Port connected to the <b>LoopE</b> port of the Injection valve.

**Note:** Ports denoted by the letter *F* are used for filling the loop and ports denoted by the letter *E* are used for emptying the loop.

Flow path	Description
Position <b>1-5</b>	The flow direction depends on the Injection valve position.
<b>By-pass</b>	The flow bypasses the loop(s). <b>By-pass</b> is the default flow path.

## Connect tubing

The table below shows recommended tubing and connectors.

Tubing label	Connection	Tubing		Connector	Tubing length (mm)
		ÄKTA pure 25	ÄKTA pure 150		
<b>L1</b>	Injection valve position <b>LoopF</b> to Loop valve position <b>F</b>	PEEK, o.d. 1/16", i.d. 0.50 mm	PEEK, o.d. 1/16", i.d. 0.75 mm	Fingertight connector, 1/16"	160
<b>L2</b>	Injection valve position <b>LoopE</b> to Loop valve position <b>E</b>	PEEK, o.d. 1/16", i.d. 0.50 mm	PEEK, o.d. 1/16", i.d. 0.75 mm	Fingertight connector, 1/16"	160

## Connect a Loop valve

The Loop valve is connected to the Injection valve instead of a loop, as described below.

Step	Action
------	--------

- |   |  |
|---|--|
| 1 | Connect port <b>E</b> on the Loop valve to port <b>LoopE</b> on the Injection valve.                           |
| 2 | Connect port <b>F</b> on the Loop valve to port <b>LoopF</b> on the Injection valve.                           |
| 3 | Connect one or many loops to the Loop valve. See <a href="#">Section 5.7 Sample application, on page 179</a> . |

**Note:**

*Always use the the first positions of the valve for the connected loops (e.g., if three loops will be used, use port **1F-3F** and the corresponding ports **1E-3E**) to avoid cross-contamination.*

**Note:** *It is possible to place the Loop valve in other positions in the flow path than the one described above. However, the volume used for washes will then be incorrect, just as the system configuration shown in the process picture.*

## 2.4.8 Column valves

### Function of the Column valves

The Column valves are used to connect columns to the system, and to direct the flow onto the column. The Column valves available for ÄKTA pure and their functions are described in the table below.

Label in		Function
ÄKTA pure 25	ÄKTA pure 150	
<b>V9-C</b>	<b>V9H-C</b>	Connects columns to the system and allows the user to choose column, flow direction through the column, or to bypass the columns. Up to five columns can be connected to the valve.
<b>V9-C2</b>	<b>V9H-C2</b>	Optional column valve allows up to ten columns to be connected when combined with <b>V9-C</b> or <b>V9H-C</b> . The user can choose column, flow direction through the column, or to bypass the columns.
<b>V9-Cs</b>	<b>V9H-Cs</b>	Connects one column to the system and allows the user to choose flow direction through the column, or to bypass the column.

The inlet and outlet ports of Column valves **V9-C**, **V9H-C** and **V9-C2**, **V9H-C2** have built in pressure sensors that measure the actual pressure over the column. For further information on the pressure sensors, see [Function of pressure monitors integrated in Column valves V9-C or V9H-C, on page 68](#).

Column valves **V9-Cs** and **V9H-Cs** have no pressure sensors. See [Section 5.5 Connect a column, on page 172](#) for information on how to set the pressure alarm to protect the column when using **V9-Cs** or **V9H-Cs**.

### Location and illustration of Column valves

#### ÄKTA pure with one column valve

The illustration below shows the recommended location of the column valve when only **V9-Cs** or **V9-C** are installed.



Part	Function
1	Column valve <b>V9-Cs</b> or <b>V9H-Cs</b> (no integrated pressure sensors)
2	Column valve <b>V9-C</b> or <b>V9H-C</b> (integrated pressure sensors)

### ÄKTA pure with two column valves

The standard configuration for **ÄKTA pure** is with one column valve. Valves **V9-C** or **V9H-C** have 5 column positions. To increase the number of column positions to 10, **V9-C** or **V9H-C** must be combined with a second column valve (either **V9-C2** or **V9H-C2**).

Use positions 8 and 9 to install two column valves with the shortest possible flow path. Install the first column valve (**V9-C** or **V9H-C**) in position 8. Install the second column valve (**V9-C2** or **V9H-C2**) in position 9.



### Ports and flow paths of the column valves

The illustration and tables below describe the different ports of and flow paths through Column valves **V9-C**, **V9H-C**, **V9-C2** and **V9H-C2**. In the example below the column is connected to column position 4 and the valve is labeled **V9-C**.

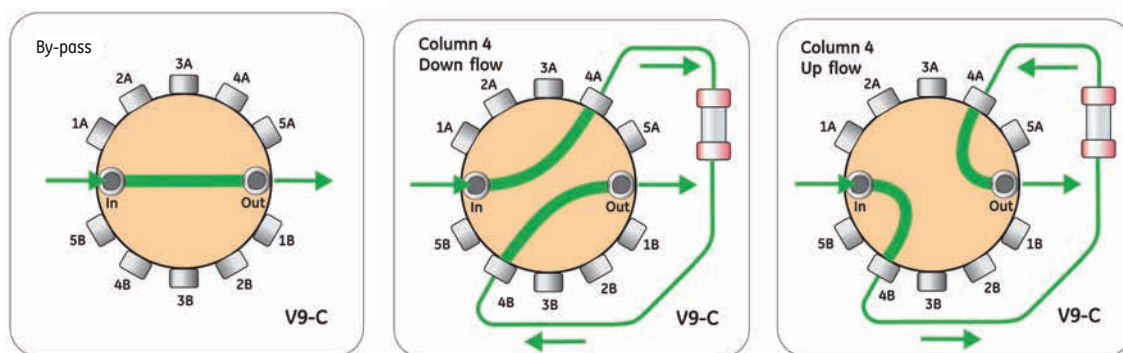

Port	Description
<b>In</b>	Inlet from Injection valve via a built-in pressure monitor.



Port	Description
<b>1A-5A</b>	Ports for connection to the top of columns.
<b>1B-5B</b>	Ports for connection to the bottom of columns.
<b>Out</b>	Outlet to UV monitor via a built-in pressure monitor.

Flow path	Description
<b>By-pass</b>	The flow bypasses the column(s). <b>By-pass</b> is the default flow path.
<b>Down flow</b>	The flow direction is from the top of the column to the bottom of the column. Down flow is the default flow direction.
<b>Up flow</b>	The flow direction is from the bottom of the column to the top of the column.

## Ports and flow paths of Column valves V9-Cs and V9H-Cs

The illustration and tables below describe the different ports and flow paths of Column valve **V9-Cs**.

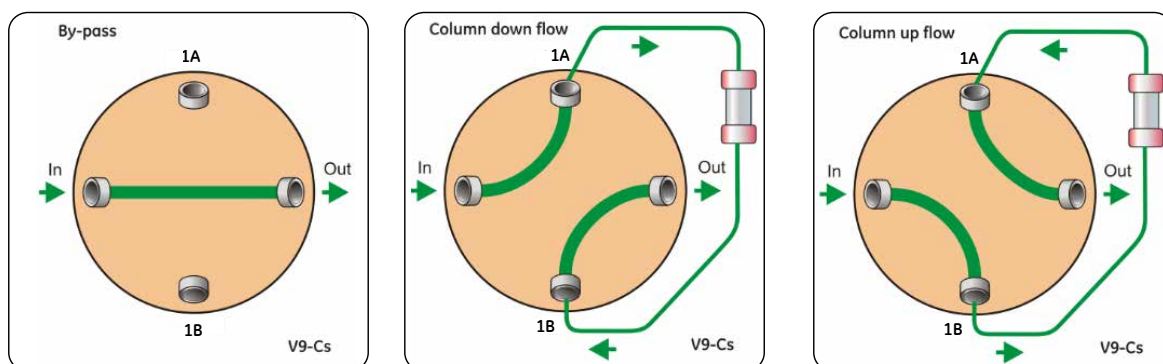

Port	Description
<b>In</b>	Inlet from Injection valve.
<b>1A</b>	Port for connection to the top of a column.
<b>1B</b>	Port for connection to the bottom of a column.
<b>Out</b>	Outlet to UV monitor.

Flow path	Description
<b>By-pass</b>	The flow bypasses the column. <b>By-pass</b> is the default flow path.

Flow path	Description
<b>Down flow</b>	The flow direction is from the top of the column to the bottom of the column. Down flow is the default flow direction.
<b>Up flow</b>	The flow direction is from the bottom of the column to the top of the column.

## Connect tubing

The table below shows recommended tubing and connectors.

Tubing label	Connection	Tubing		Connector	Tubing length (mm)
		ÄKTA pure 25	ÄKTA pure 150		
<b>5</b>	Injection valve to Column valve				100
<b>5C2</b>	Standard column valve and extra column valve	PEEK, o.d. 1/16", i.d. 0.50 mm (orange)	PEEK, o.d. 1/16", i.d. 0.75 mm (green)	Fingertight connector, 1/16"	100
<b>6</b>	Column valve to UV monitor				160

Follow the instructions below to connect tubing to the column valves.

Step	Action
1	If no Column valve is installed, remove the Union F/F between tubing <b>5</b> and tubing <b>6</b>
2	Connect tubing between Injection valve, Column valve and UV monitor according to the table above.

**Note:** The built-in pressure sensors for column valve(s) **V9-C**, **V9-C2**, **V9H-C** and **V9H-C2** have to be re-calibrated after installation. See [Calibrate the monitors](#), on page 305.

**Note:** When using two column valves, only the pre-column pressure sensor on the first valve and the post-column pressure sensor on the second valve are used.

## 2.4.9 Versatile valve

### Function of the Versatile valve

The Versatile valve is a 4-port, 4-position valve, which can be used to add extra features to the flow path. For example, the valve can be used to connect external equipment to the flow path during parts of a run. The versatile valve can be installed in any position. The versatile valve is labeled **V9-V** or **V9H-V**.

It is possible to install up to four versatile valves simultaneously in ÄKTA pure. The configuration is defined by the module's Node ID.

### Ports and flow paths of the Versatile valve

The illustration and table below describe the different ports of and flow paths through the Versatile valve. The valve has four ports (**1-4**).

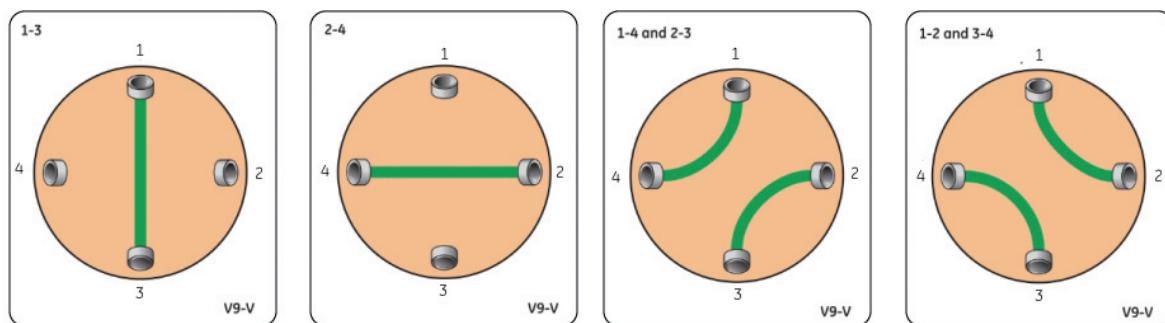

The Versatile valve has four available sets of flow paths; two where a single flow channel is used and two where the flow can be directed through two different channels simultaneously.

Flow path	Description
<b>1-3</b>	A single flow channel where the flow is directed between port <b>1</b> and port <b>3</b> .
<b>2-4</b>	A single flow channel where the flow is directed between port <b>2</b> and port <b>4</b> .
<b>1-4 and 2-3</b>	Two simultaneously used flow channels where the flow is directed between port <b>1</b> and port <b>4</b> and between port <b>2</b> and port <b>3</b> .
<b>1-2 and 3-4</b>	Two simultaneously used flow channels where the flow is directed between port <b>1</b> and port <b>2</b> and between port <b>3</b> and port <b>4</b> .

## 2.4.10 pH valve

### Function of the pH valve

The pH valve is used to direct the flow to a pH electrode when inline monitoring of pH is desired during a run. The pH valve is labeled **V9-pH** for ÄKTA pure 25 and **V9H-pH** for ÄKTA pure 150.

The pH valve has an integrated flow cell in which the pH electrode can be installed.

It is recommended to connect a Flow restrictor to the pH valve. The flow restrictor is used to generate a back pressure high enough to prevent the formation of air bubbles in the UV flow cell.

The valve directs the flow to the pH electrode and to the flow restrictor, or bypasses one or both.

**Note:** *The Flow restrictor is normally included in the flow path after the Conductivity monitor. When installing the pH valve on ÄKTA pure, the flow restrictor should be moved from its normal position on the conductivity monitor to the pH valve.*

### Location and illustration of the pH valve

The illustration below shows the recommended location, together with a detailed view of the pH valve.

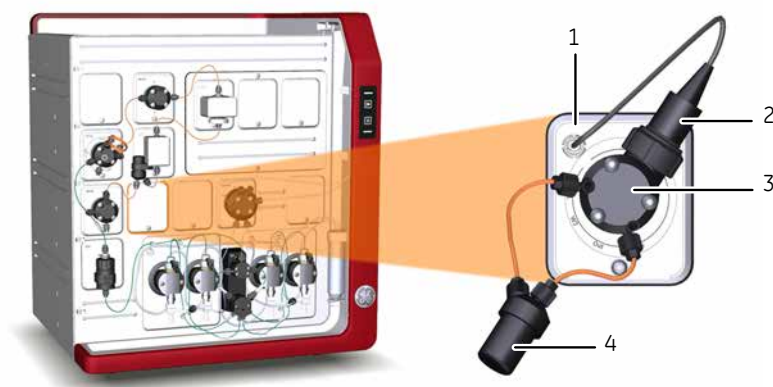

Part	Description
1	pH valve
2	pH electrode
3	pH flow cell
4	Flow restrictor

## Ports and flow paths of the pH valve

The illustration and table below describe the different ports of and flow paths through the pH valve, in this example labeled **V9-pH**.

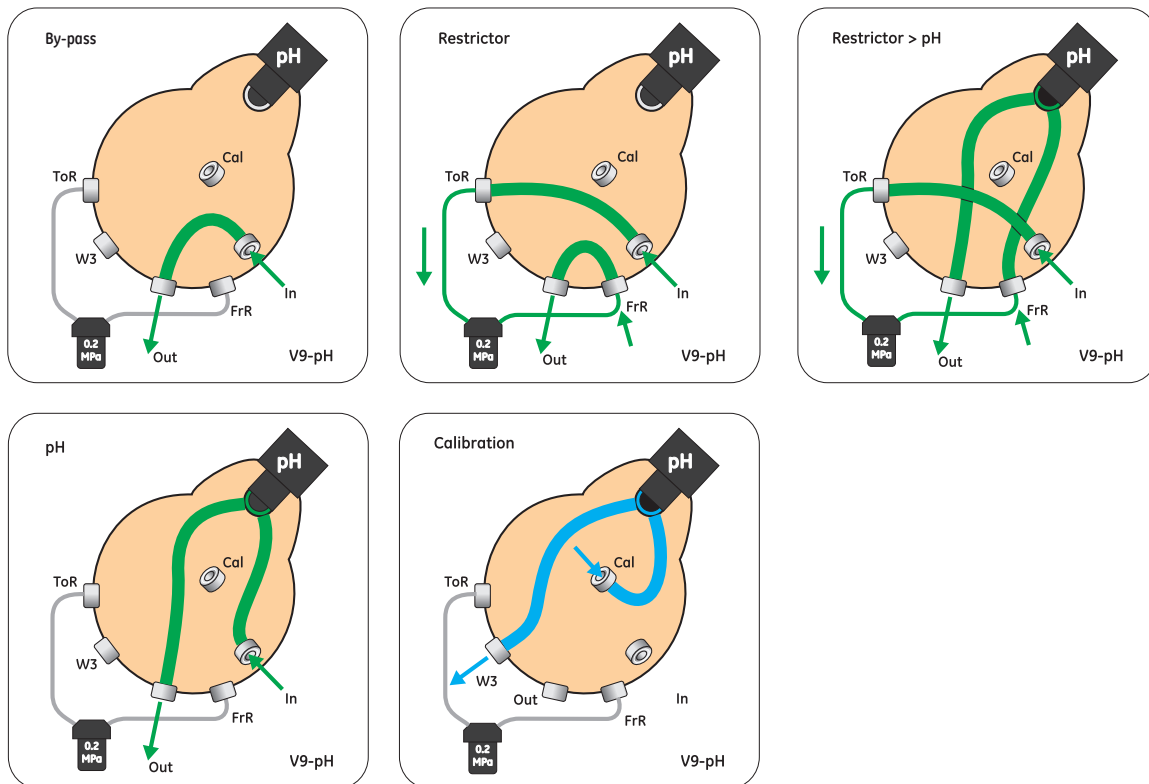

- Primary flow path
- Flow path for calibrations
- Closed flow path

Port	Description
<b>In</b>	From Conductivity monitor
<b>ToR</b>	To Flow restrictor
<b>FrR</b>	From Flow restrictor
<b>Out</b>	To Outlet valve
<b>Cal</b>	Calibration port
<b>W3</b>	To Waste

Flow path	Description
<b>By-pass</b>	Both pH electrode and Flow restrictor are bypassed.
<b>Restrictor</b>	Flow restrictor is in use and pH electrode is bypassed.
<b>Restrictor and pH</b>	Both pH electrode and Flow restrictor are in use.
<b>pH</b>	pH electrode is in use and Flow restrictor is bypassed.
<b>Calibration</b>	Flow path used when calibrating the pH monitor and when filling the pH flow cell with storage solution. The <b>Cal</b> port is used to inject solution into the flow cell using a syringe. Excess solution leaves the valve through port <b>W3</b> .

## pH monitor

The pH monitor continuously measures the pH of the buffer and eluted proteins when the pH electrode is inline. A pH electrode can be installed in the pH flow cell. For instruction on how to install the pH electrode, see [Section 7.5.2 Replace the pH electrode, on page 275](#). The pH electrode should not be exposed to more than 0.5 MPa during a normal run, but can withstand pressure spikes of 0.8 MPa. It is therefore important to place it after the column.

The illustration below shows the location of the pH flow cell and a pH electrode installed in the pH valve.

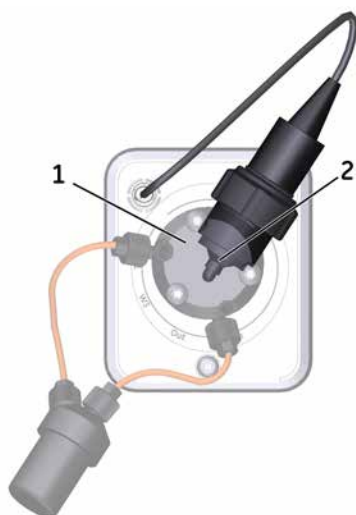

Part	Description
1	pH flow cell
2	pH electrode

## Connect tubing

The table below shows recommended tubing.

Tubing label	Connection	Tubing		Connector	Tubing length (mm)
		ÄKTA pure 25	ÄKTA pure 150		
<b>8pH</b>	Conductivity monitor to port <b>In</b>	PEEK, o.d. 1/16", i.d. 0.50 mm	PEEK, o.d. 1/16", i.d. 0.75 mm	Fingertight connector, 1/16"	180
<b>1R</b>	Flow restrictor to port <b>ToR</b>	PEEK, o.d. 1/16", i.d. 0.50 mm	PEEK, o.d. 1/16", i.d. 0.75 mm	Fingertight connector, 1/16"	80
<b>2R</b>	Flow restrictor to port <b>FrR</b>	PEEK, o.d. 1/16", i.d. 0.50 mm	PEEK, o.d. 1/16", i.d. 0.75 mm	Fingertight connector, 1/16"	80
<b>9pH</b>	Port <b>Out</b> to Outlet valve	PEEK, o.d. 1/16", i.d. 0.50 mm	PEEK, o.d. 1/16", i.d. 0.75 mm	Fingertight connector, 1/16"	160
N/A	to Calibration port <b>Cal</b>	N/A	N/A	N/A	N/A
<b>W3</b>	Port <b>W3</b> to Waste	ETFE I.D. 1 mm	ETFE I.D. 1 mm	Fingertight connector, 1/16"	1500

**Note:** The dimensions of the PEEK tubing depends on which tubing kit that is used. See [Section 9.3 Tubing and connectors](#), on page 420 for more information.

## 2.4.11 Outlet valves

### Function of the outlet valves

The outlet valve is used to direct the flow to the fraction collector, to an outlet port, or to waste. The table below shows the labeling of the outlet valves for ÄKTA pure 25 and ÄKTA pure 150.

Label in		Description
ÄKTA pure 25	ÄKTA pure 150	
<b>V9-O</b>	<b>V9H-O</b>	10 outlet ports
<b>V9-Os</b>	<b>V9H-Os</b>	1 outlet ports

### Location and illustration of outlet valves

The illustration below shows the recommended location, together with a detailed view of the outlet valves. In this example the valves are labeled **V9-Os** and **V9-O**.



### Ports of Outlet valves V9-O and V9H-O

The illustration below shows the ports of Outlet valve **V9-O** and **V9H-O**, in this example labeled **V9-O**.

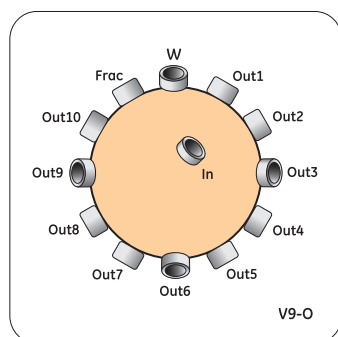

Port	Description
<b>In</b>	Inlet port



Port	Description
<b>Out1 - Out10</b>	Outlet ports 1 - 10
<b>Frac</b>	Port to Fraction collector  <b>Note:</b> <i>If a secondary <b>Fraction collector F9-R</b> is used it should be connected to port <b>Out10</b>.</i>
<b>W</b>	Waste port

### Ports of Outlet valves V9-Os and V9H-Os

The illustration below shows the ports of Outlet valve **V9-Os**.

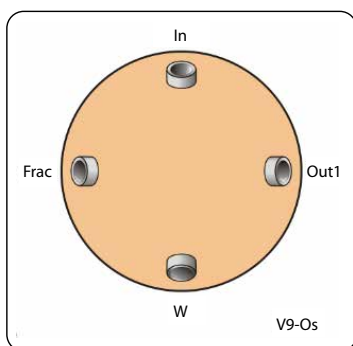

Port	Description
<b>In</b>	Inlet port
<b>Out1</b>	Outlet port
<b>Frac</b>	Port to fraction collector  <b>Note:</b> <i>If a secondary <b>Fraction collector F9-R</b> is used it should be connected to port <b>Out1</b>.</i>
<b>W</b>	Waste port

## Connect tubing

The table below shows recommended tubing and connectors.

Tubing label	Connection	Tubing		Connector	Tubing length (mm)
		ÄKTA pure 25	ÄKTA pure 150		
<b>9</b>	Flow restrictor to Outlet valve	PEEK, o.d. 1/16", i.d. 0.50 mm	PEEK, o.d. 1/16", i.d. 0.75 mm	Fingertight connector, 1/16"	135
<b>9pH</b>	pH valve to Outlet valve	PEEK, o.d. 1/16", i.d. 0.50 mm	PEEK, o.d. 1/16", i.d. 0.75 mm	Fingertight connector, 1/16"	160
<b>Out1 - Out10</b>	Outlets from the outlet valves	ETFE, o.d. 1/8", i.d. 1 mm	ETFE, o.d. 1/8", i.d. 1 mm	Fingertight connector, 1/16"	1500

**Note:** If ÄKTA pure previously has been configured without an Outlet valve, remove the Union F/F between tubing **9** and tubing **W** before installation of the Outlet valve. Then connect tubing **9** to the **In** port on the Outlet valve and the waste tubing **W** to the **W** port on the Outlet valve.

## 2.4.12 Pressure monitors

### Introduction

This section describes the location and function of the pressure monitors.  
Up to four pressure monitors are included in ÄKTA pure.

### Function of the system pump and the sample pump pressure monitors

Up to four pressure monitors are included in ÄKTA pure. One pressure monitor is always connected to the system pumps and one pressure monitor is part of the Sample pump (**S9** or **S9H**). The monitors of the pumps are both labelled **R9**.

The System pump pressure monitor measures the pressure after the system pumps, the system pressure. The pressure monitor of the sample pump measures the pressure after the sample pump, the sample pressure. To provide a reading of the highest pressure in the system there are connections to all pump cylinders.

The pressure monitor also contains pump flow restrictors in order to stop siphoning effects. Siphoning effects can occur if tubing in the system is disconnected while the inlet tubing is immersed in buffers that are placed on a higher level than the pump.

### Location and illustration of System pressure monitor

The illustration below shows the location, together with a detailed view of System pressure monitor.



Part	Description
1	Pressure monitor
2	Pump flow restrictors

## Function of pressure monitors integrated in Column valves V9-C or V9H-C

Pressure monitors are integrated into the column valves: **V9-C**, **V9H-C**, **V9-C2**, and **V9H-C2**. Column valves **V9-Cs** and **V9H-Cs** do not have pressure monitors.

Pressure monitors are integrated in the inlet and outlet ports of the column valve to measure pre-column pressure (A), and post-column pressure (B). The Delta column pressure (C), or pressure drop, is the difference between the pre- and the post-column pressure.

Pressure alarms can be set for both the pre-column pressure and the Delta-column pressure. Pressure control of flow can use either the pre-column pressure or the Delta-column pressure.

The table below shows the pressure monitor settings when the instrument is configured with one or two column valves. Set the **pre-column** and **post-column** pressure monitors by turning the arrows on the switches on the **left** and **right** sides of the module with a screwdriver. Set Node ID for the **column valve** by turning the arrows in the two rotating switches at the **back** of the module.

**Note:**

Column valves **V9-Cs** and **V9H-Cs** do not have pressure monitors.

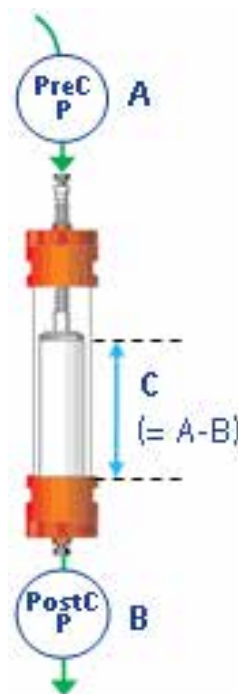

Module	Label	Settings	
		Node ID	Pressure monitor
<b>First column valve</b>	<b>V9-C</b> or <b>V9H-C</b>	5	NA
Pre-column pressure monitor in column valve <b>V9-C</b> and <b>V9H-C</b>	NA	NA	2
Post-column pressure monitor in column valve <b>V9-C</b> and <b>V9H-C</b>	NA	NA	3
<b>Second column valve</b>	<b>V9-C2</b> or <b>V9H-C2</b>	6	NA
Pre-column pressure monitor in column valve <b>V9-C2</b> and <b>V9H-C2</b>	NA	NA	4
Post-column pressure monitor in column valve <b>V9-C2</b> and <b>V9H-C2</b>	NA	NA	5
Column valve <b>V9-Cs</b> and <b>V9H-Cs</b>	<b>V9-Cs</b> or <b>V9H-Cs</b>	7	NA

## 2.4.13 UV monitors

### Introduction

This section describes the design and function of UV monitors **U9-M** and **U9-L**. The modules include a monitor unit and a detector with a UV flow cell.

### Function of UV monitor U9-M

UV monitor **U9-M** measures the UV absorbance at a wavelength range of 190 to 700 nm.

A flip-mode enables measuring of UV/Vis absorbance at three wavelengths simultaneously during a run. The second and third wavelength can be turned off or on in method phase properties, by manual instructions or in system settings. The UV lamp can be shut off manually if not needed during a run. The lamp starts automatically for next run.

**Note:** Installation of UV monitor **U9-M** should only be performed by GE Service personnel.

**Note:** The resolution is decreased when more than one wavelength is used simultaneously due to lower sampling frequency per wavelength. Do not use more wavelengths than necessary.

### Location and illustration of UV monitor U9-M

The illustration below shows the location of UV monitor **U9-M**, together with a detailed view of the monitor unit and detector. The monitor unit is labelled **U9-M** and the detector **U9-D**.

**Note:** When UV monitor **U9-M** is used, the entire Multi-module panel shown in the illustration is replaced by **U9-M**.

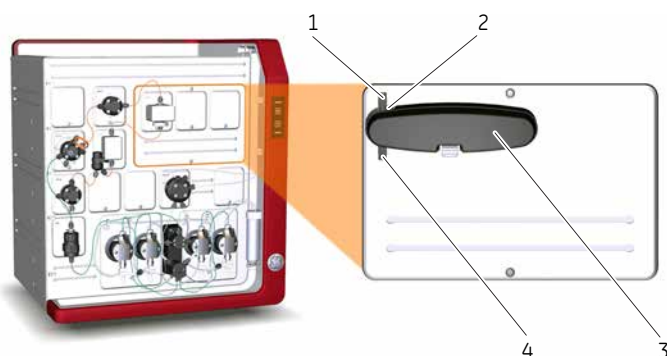

Part	Description
1	Inlet
2	UV flow cell. Three different path lengths are available: 0.5 mm, 2 mm (default) and 10 mm
3	UV detector
4	Outlet

## Function of UV monitor U9-L

The UV monitor **U9-L** measures the UV absorbance at the fixed wavelength of 280 nm.

It is not possible to vary the wavelength. Therefore it is not shown in the **Phase Properties** pane in **Method Editor**. The UV lamp can be shut off manually if not needed during a run. The lamp starts automatically for next run.

## Location and illustration of UV monitor U9-L

The illustration below shows the recommended location of UV monitor **U9-L**, together with a detailed view of the monitor and detector. The UV monitor **U9-L** requires that the Multi-module panel is installed, see [Example of a typical configuration of the wet side, on page 15](#). The UV monitor can also be installed in an Extension box, see [Extension box, on page 85](#).

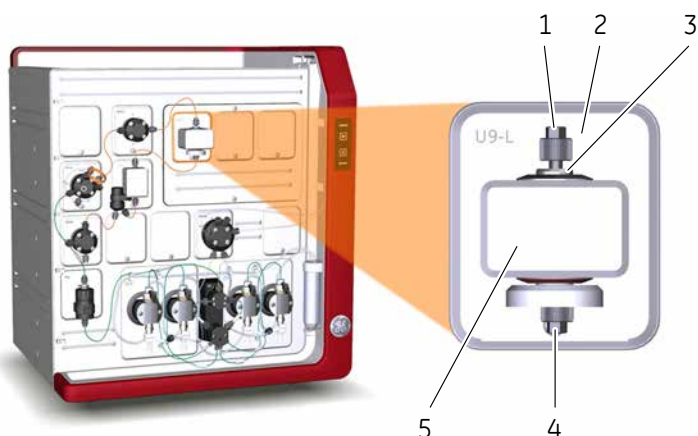

Part	Description
1	Inlet
2	UV monitor <b>U9-L</b>
3	UV flow cell. Two different path lengths are available: 2 mm (default) and 5 mm
4	Outlet
5	UV detector

## Using two UV monitors

It is possible to use two UV monitors in ÄKTA pure, in two combinations. The configuration is defined by the module's Node ID.

- UV monitor U9-M together with UV monitor U9-L, 2nd
- UV monitor U9-L together with UV monitor U9-L, 2nd

**Note:** When using two UV monitors, the signal from the first UV monitor is by default used for peak fractionation. This can be changed by editing the text instruction **Fraction Collection:Peak fractionation parameters:Signal source** and choosing **UV 2nd** as **Signal source**.

**Note:** When using two UV monitors with different cell lengths to increase the UV absorption dynamic range, the U9-L signal comes from the real cell length and has to be calibrated for exact calculations. The U9-M signal is automatically calibrated to nominal cell length.

UV monitor U9-L, 2nd can be located anywhere in the flow path and is therefore shown in the **Process Picture** in UNICORN as a component without a fixed place. This means that it is possible to place U9-L, 2nd before the other UV monitor in the flow path.

**Note:** If **U9-L 2nd** is placed on the high pressure side of the column, pressure limits have to be considered. See [UV monitor options, on page 416](#)

## Connect tubing

The table below shows the tubing and connectors to be used with UV monitor **U9-L**.

**Note:** If a second UV monitor is used, the tubing for this has to be cut manually.

Tubing label	Connection	Tubing		Connector	Tubing length (mm)
		ÄKTA pure 25	ÄKTA pure 150		
<b>6</b>	Tubing to UV monitor U9-L	PEEK, o.d. 1/16", i.d. 0.50 mm	PEEK, o.d. 1/16", i.d. 0.75 mm	Fingertight connector, 1/16"	160
<b>7</b>	Tubing from UV monitor U9-L	PEEK, o.d. 1/16", i.d. 0.50 mm	PEEK, o.d. 1/16", i.d. 0.75 mm	Fingertight connector, 1/16"	170

**Note:** To perform a run with the flow in reverse direction through UV monitor **U9-L**, a longer tubing **7** is needed. Replace the 170 mm tubing from the UV monitor with tubing that is 210 mm long and adjust the delay volume accordingly. For example, changing from 170 mm to 210 mm for 0.5 mm i.d. tubing increases the delay volume with 8 µl.

## 2.4.14 Conductivity monitor

### Function of the Conductivity monitor

The Conductivity monitor continuously measures the conductivity of buffers and eluted proteins. The monitor is labelled **C9**.

The Conductivity flow cell has two electrodes positioned in the flow path of the cell. An alternating voltage is applied between the electrodes and the resulting current is measured and used to calculate the conductivity of the eluent.

The conductivity is automatically calculated by multiplying the measured conductance by the cell constant of the flow cell. The cell constant is factory-calibrated on delivery but can be re-calibrated if needed, see [Section 7.7.3 Calibrate the Conductivity monitor, on page 308](#).

As variation in temperature influences conductivity readings, the conductivity flow cell is fitted with a temperature sensor that measures the temperature of the eluent. A temperature compensation factor is used to report the conductivity in relation to a set reference temperature.

### Location and illustration of the Conductivity monitor

The illustration below shows the recommended location of Conductivity monitor **C9**, together with a detailed view of the monitor.

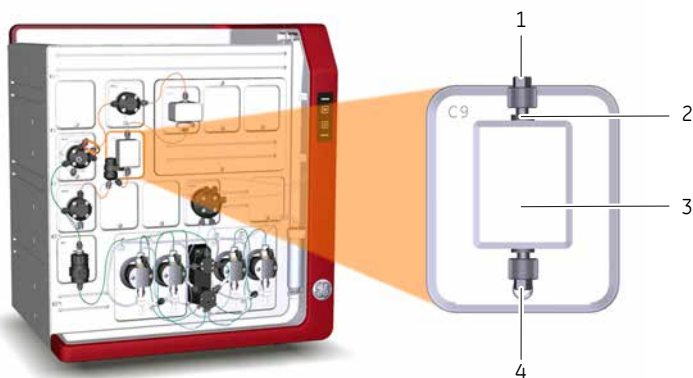

Part	Description
1	Inlet
2	Conductivity flow cell
3	Conductivity monitor
4	Outlet



## Connect tubing

The table below shows recommended tubing and connectors.

Tubing label	Connection	Tubing		Connector	Tubing length (mm)
		ÄKTA pure 25	ÄKTA pure 150		
<b>7</b>	UV monitor U9-L to Conductivity monitor C9	PEEK, o.d. 1/16", i.d. 0.50 mm	PEEK, o.d. 1/16", i.d. 0.75 mm	Fingertight connector, 1/16"	170
<b>8</b>	Conductivity monitor C9 to Flow restrictor	PEEK, o.d. 1/16", i.d. 0.50 mm	PEEK, o.d. 1/16", i.d. 0.75 mm	Fingertight connector, 1/16"	95

## 2.4.15 Flow restrictor

### Function of Flow restrictor FR-902

The Flow restrictor is included in the flow path to generate a steady back pressure of approximately 0.2 MPa, to prevent formation of air bubbles in the UV flow cell.

**Note:** Do not remove the flow restrictor to lower the pressure in the system. There is a risk that air bubbles cause large disturbances in the UV flow cell. Use the automatic pressure control function to avoid pressure alarms, see [Recommended pressure control parameters, on page 501](#)

### Location and illustration of Flow restrictor FR-902

The Flow restrictor is normally included in the flow path after the Conductivity monitor. The Conductivity monitor is equipped with a special holder for the Flow restrictor.

The illustration below shows Flow restrictor **FR-902** fitted on the Conductivity monitor.

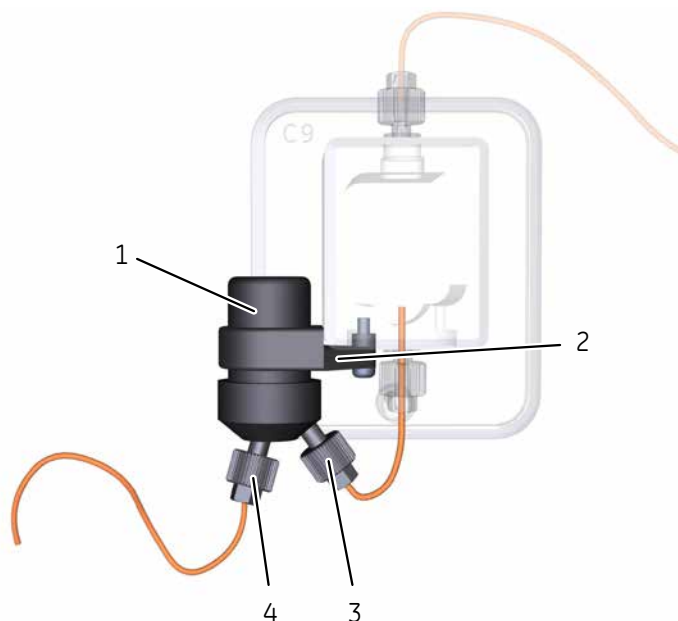

Part	Function
1	Flow restrictor
2	Holder
3	Inlet
4	Outlet

If ÄKTA pure is fitted with pH valve **V9-pH** or **V9H-pH** the Flow restrictor has to be moved from the Conductivity monitor to the pH valve.

The illustration below shows Flow restrictor **FR-902** fitted on the pH valve.

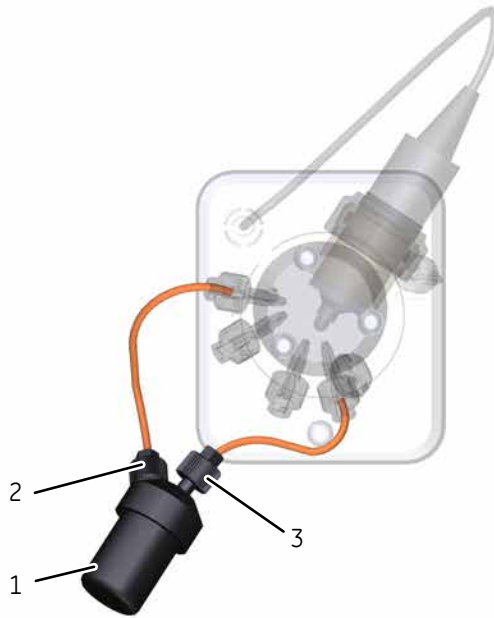

Part	Function
1	Flow restrictor
2	Flow restrictor inlet connection from pH valve <b>ToR</b> port
3	Flow restrictor outlet connection to pH valve <b>FrR</b> port

## 2.5 Installation of internal modules

### Introduction

Optional modules and valves are easy to install in the instrument. The existing module or Module Panel is removed with a Torx T20 screwdriver and the cable is disconnected. The cable is then connected to the optional module, which is subsequently inserted into the instrument. The newly installed module is then added to the **System properties** in UNICORN.

### Node ID

All of the available optional modules are preconfigured to give the desired function. However, the function of a module or valve can be changed by changing its Node ID. Node ID is a unit number designation that is used by the instrument to distinguish between several units of the same type.

In a troubleshooting situation it may be useful to check a valve's or module's Node ID. Refer to [Section 9.16 Node IDs, on page 502](#) for a list of Node IDs for valves and modules.

**Note:** *The function of a valve or module is defined by its Node ID, not by its physical position.*

The Node ID is set by positioning the arrows of the one or two rotating switches at the back of the valve. Use a screwdriver to set the arrows of the switches to the desired number.

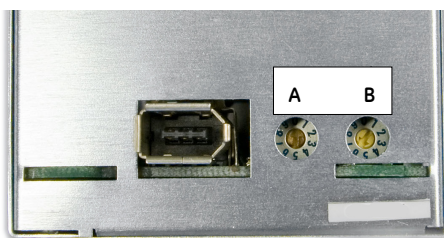

The illustration shows an example of a valve module with two rotating switches.

- The first rotating switch, labeled **A**, sets the tens
- The second switch, labeled **B**, sets the units.

### Hardware installation of a module

The instruction below describes how to install a module in the instrument.

**Note:** *The illustrations show the principle how to install an optional module. The position of the module on the instrument and the used type of module will depend on the module being installed.*



#### CAUTION

**Disconnect power.** Always switch off power to the ÄKTA pure instrument before replacing any of its components, unless stated otherwise in the user documentation.

- | Step | Action   |
|------|--|
| 1    | Disconnect power from the instrument by switching off the instrument power switch.   |
| 2    | Loosen the connectors and remove the tubing from the existing module.<br><b>Note:</b><br><i>This step does not apply for a Module Panel.</i> |
| 3    | Loosen the module with a Torx T20 screwdriver.   |



- |   |                    |
|---|--------------------|
| 4 | Remove the module. |
|---|--------------------|



- |   |   |
|---|---|
| 5 | Disconnect the cable and secure it in the slit. |
|---|---|



Step	Action
6	Connect the cable to the module to be installed.



7	Insert the module.
---	--------------------



8	Fasten it with a Torx T20 screwdriver.
---	--

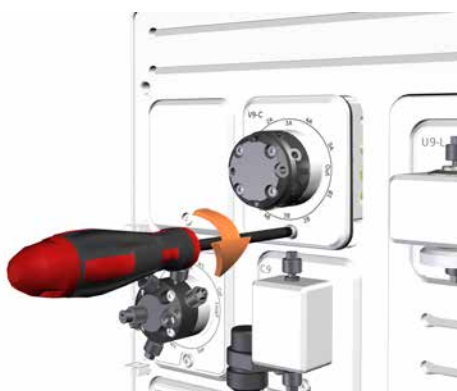

**Note:** A warning message is displayed at start up if a module has been installed in the instrument but not added to the current system configuration in UNICORN.

## Install internal modules in the Extension box

The Extension box can be used to install extra modules on the ÄKTA pure instrument. See [Extension box, on page 85](#) for more information.

## 2.6 Accessories

### Introduction

This section describes the holders and other available accessories. These are used to attach and organize columns, tubing and bottles to the ÄKTA pure instrument. The holders are attached to the instrument using the holder rails on the left side and the front of the instrument.

### Rail extension

The Rail extension rod can be used to attach accessories, eg., column holders or a Multi-purpose holder. The rod has extra rails on both sides. Push the button of the rod to attach it to a holder rail. The illustration below shows the Rail extension rod.

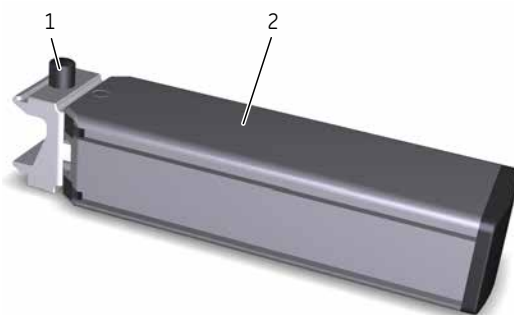

Part	Function
1	Button
2	Extension rod

### Multi-purpose holder

The Multi-purpose holder can be used to attach accessories, eg., a Loop holder or a cassette. Attach the holder to a holder rail.

The illustration below shows the Multi-purpose holder.

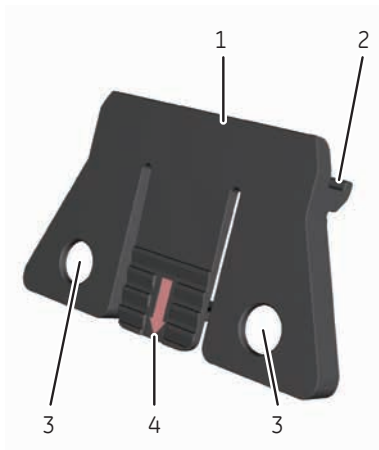

Part	Function
1	Attachment point for accessories
2	Snap-in to holder rails
3	Attachment points for tubing holders
4	Tab

## Loop holder

The Loop holder can be used to attach up to five 10 ml sample loops. Use two Multi-purpose holders to attach the holder to a holder rail.

The illustration below shows the Loop holder.



Part	Function
1	Upper attachment to multi-purpose holder
2	Lower attachment to multi-purpose holder

## Column holder

The Column holder has one position for medium sized columns and one position for small sized columns. The Column holder can also be used for bottles. Use two holders to attach long columns.

The illustration below shows the Column holder.

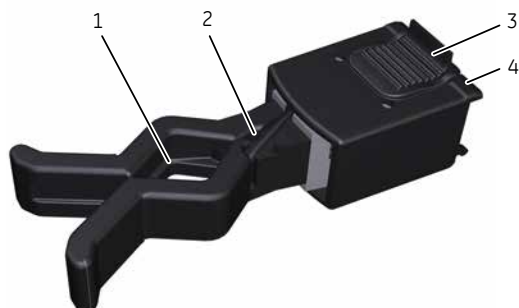

Part	Description
1	Position for a medium sized column or bottle
2	Position for a small sized column
3	Tab
4	Snap-in to holder rails



## Column clamp

The column clamp can be used to attach small sized columns. Use two clamps to attach long columns. The illustration below shows the Column clamp.

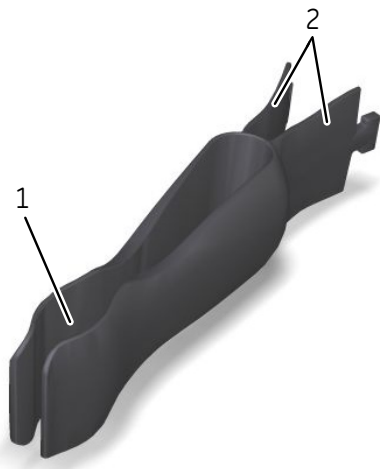

Part	Description
1	Position for a column
2	Inner end tabs

## Column holder rod

The Column holder rod can be used to attach several HiTrap™ columns. The holder has threaded ports for HiTrap columns and tubing connectors. Push the button of the holder to attach the holder to a holder rail.

The illustration below shows the Column holder rod.

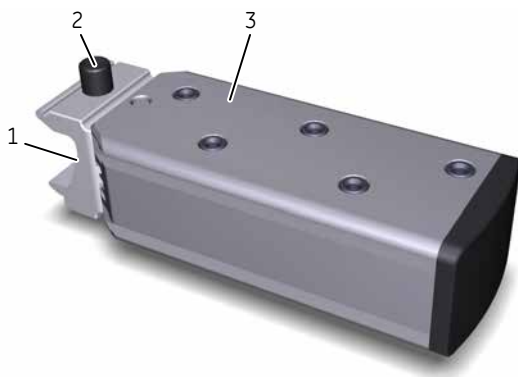

Part	Description
1	Snap-in to holder rails
2	Button
3	Column holder rod

## Flexible column holder

The Flexible column holder can be used to attach, for example, HiScreen™ columns. The illustration below shows the Flexible column holder.

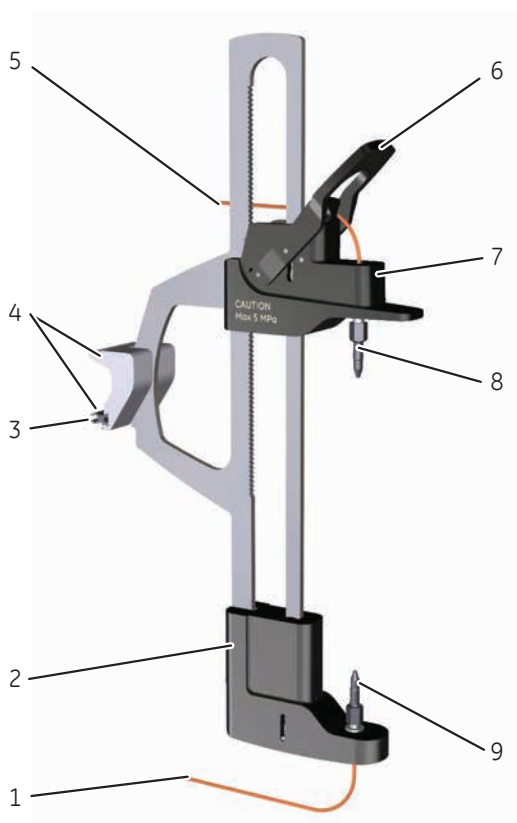

Part	Function
1	Lower tubing
2	Lower part
3	Snap-in-strips
4	Attachment part
5	Upper tubing
6	Lever
7	Upper part
8	Upper connector
9	Lower connector

## Tubing holder spool

The Tubing holder spool is used to hold and arrange tubing. The illustration below shows the Tubing holder spool.

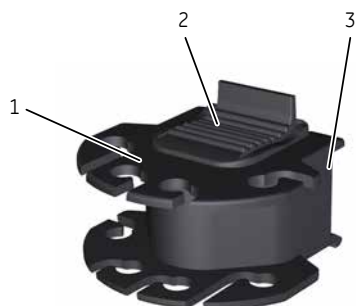

Part	Description
1	Positions for tubing
2	Tab
3	Snap-in to holder rails

## Tubing holder comb

The Tubing holder comb is used to hold and arrange tubing.  
The illustration below shows the Tubing holder comb.



Part	Description
1	Positions for tubing
2	Tab
3	Snap-in to holder rails

## Bottle holder

The Bottle holder is used for holding bottles. For example, the Bottle holder can be attached to the holder rails to hold a sample bottle.  
The illustration below shows the Bottle holder.

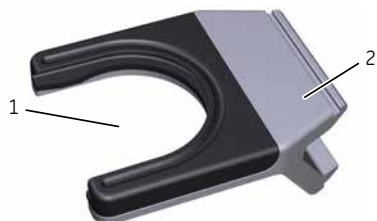

Part	Description
1	Position for bottle
2	Snap-in to holder rails

## Adapter for air sensor

The adapter for air sensor is used to hold an optional air sensor.  
The air sensor with adapter is connected to the Bottle holder, see illustrations below.

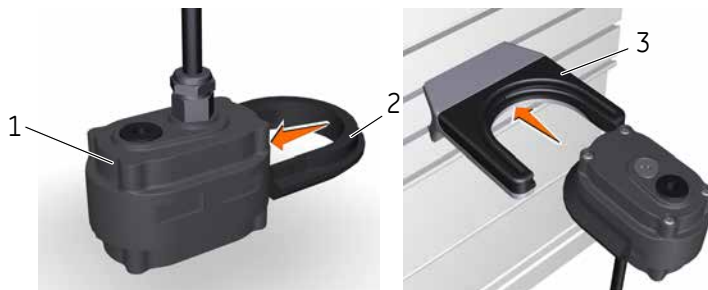

Part	Description
1	Air sensor
2	Air sensor adapter
3	Bottle holder

## Module Panel

### Description

All positions in ÄKTA pure must be occupied. Positions not used for core or optional modules must be fitted with a Module Panel.

Module Panels are installed in the same way as the other optional modules and the cable inside must be connected to the Module Panel, see [Hardware installation of a module, on page 76](#).

When an optional module is replaced by a Module panel, the removed module has to be deselected in the software configuration, see [Edit system properties, on page 127](#).

### Illustration

The illustration shows the Module Panels installed in the example configuration used in this manual.

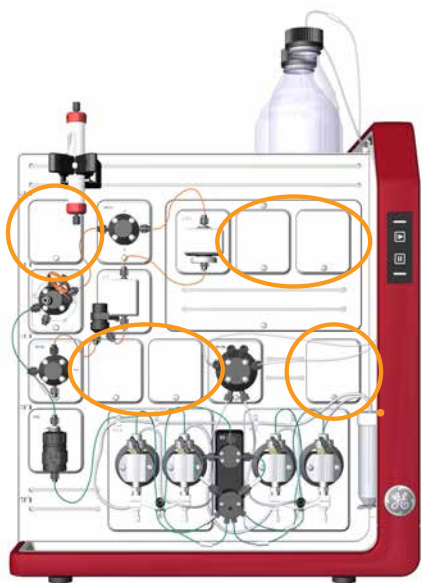

## Extension box

### Description

The Extension box can be used to install extra modules on the ÄKTA pure instrument outside the system chassis when the positions on the chassis are filled. It is possible to install up to six Extension boxes with extra modules when using ÄKTA pure. See the Extension box instruction for more information.

### Location

The illustration below shows an Extension box with a module mounted on the side of ÄKTA pure.

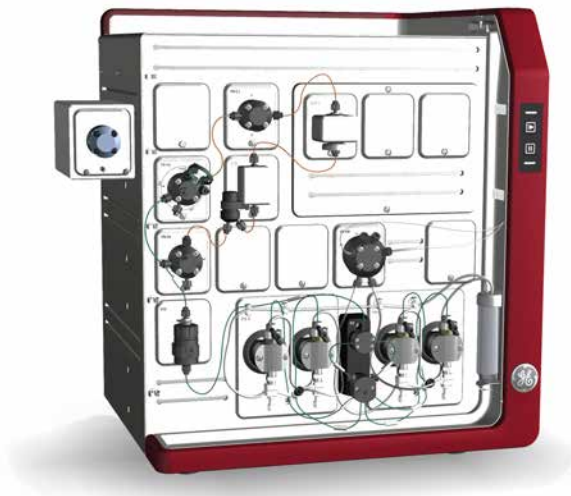

The Extension box can be mounted in three ways.

- On the side of ÄKTA pure.
- Standing on top of or next to ÄKTA pure.
- On a Rail extension rod (29-0113-52) on ÄKTA pure.

# 3 ÄKTA pure external modules

## About this chapter

This chapter provides an overview of the external modules that can be connected to the ÄKTA pure instrument. A brief description of how to connect external modules is also provided.

---

## In this chapter

This chapter contains the following sections:

Section	See page
3.1 External air sensors	87
3.2 Fraction collector F9-C	89
3.3 Fraction collector F9-R	103
3.4 Sample pump S9 and S9H	107
3.5 I/O-box E9	111
3.6 Connection of external modules	121

---

## 3.1 External air sensors

### Introduction

Up to four external air sensors can be added to ÄKTA pure, and there are two different versions to choose from. They differ in internal diameter and optimal position on the instrument.

The air sensors can be attached to the instrument using the rails and holders, see [Adapter for air sensor, on page 83](#). No Module Panels need to be removed.

In addition to be used for preventing air from entering the system, the external air sensors can be used together with System pump A, or an Sample pump to load the entire sample volume.

### Air sensor L9-1.5

**L9-1.5** has a 1.5 mm inner diameter and is designed for i.d. 1.6 mm FEP, ÄKTA pure 25, and for i.d. 2.9 mm FEP tubing, ÄKTA pure 150, at the low pressure side before the pumps. It is installed in the flow path before the system pumps or the sample pump and is used to prevent air entering the subsequent module.

### Air sensor L9-1.2

**L9-1.2** has a 1.2 mm inner diameter and is designed for o.d. 1/16" tubing at the high pressure side after the pumps. It is installed after the injection valve and is used to prevent air entering the column.

**Note:** *L9-1.2 can be used in the same fashion as L9-1.5 if O.D. 1/16" ETFE tubing is used between the air sensor and the inlet valve.*

## Tubing connections

### Air sensor L9-1.5

Connection between...	Tubing		Connector		Tubing length (mm)
	ÄKTA pure 25	ÄKTA pure 150	ÄKTA pure 25	ÄKTA pure 150	
<b>L9-1.5</b> and inlet valves	FEP, o.d. 1/8", i.d. 1.6 mm	FEP, o.d. 3/16", i.d. 2.9 mm	Tubing connector, 5/16" + Ferrule (yellow), 1/8"	Tubing connector, 5/16" + Ferrule (blue), 3/16"	See note

**Note:** *When sample is loaded at high flow rate and the external air sensor is placed before the pump that is used for loading the sample, it is necessary to use longer tubing to ensure that no air reaches the pump. Use tubing with the minimum lengths given below between the valve located before the pump and the external air sensor. The length applies for maximum flow rate, but shorter tubing can be used at lower flow rates.*

- Sample pump S9: 40 cm.
- Sample pump S9H: 20 cm.

**Air sensor L9-1.2**

Connection between...	Tubing	Connector	Tubing length (mm)
Injection valve and <b>L9-1.2</b>	PEEK, o.d. 1/16"	Fingertight connector, 1/16"	100
<b>L9-1.2</b> and Column valve/the connected column	PEEK, o.d. 1/16"	Fingertight connector, 1/16"	100



## 3.2 Fraction collector F9-C

### About this section

This section shows an overview of Fraction collector F9-C.  
Technical details are found in the ÄKTA pure *User manual*.

---

### In this section

This section contains the following subsections:

Section	See page
3.2.1 Function	90
3.2.2 Fraction collector F9-C illustrations	92
3.2.3 Cassettes, Cassette tray and racks	96
3.2.4 Connect tubing to the ÄKTA pure instrument	102

---

## 3.2.1 Function

### Introduction

Fraction collector F9-C can collect fractions in deep well plates, tubes of different sizes or bottles. Up to six cassettes for deep well plates and tubes can be used. The cassettes can be used in any combination and are placed on the Cassette tray. A rack for 50 ml tubes and a rack for 250 ml bottles are also available.

Scanner functions detect which types of trays, racks, cassettes and deep well plates that are used in each run.

The Cassette tray or one of the racks is placed inside the fraction collector. A height exclusion bar ensures that the bottles, tubes and deep well plates are correctly positioned and cannot damage the Dispenser head. The Tray catch and positioning discs on the floor of the fraction collector guide the Cassette tray or the rack into the correct position.

---

### Scanning of Cassettes

When the door of the fraction collector is closed automatic scanning is performed. There are two types of scanning procedures:

- **Full scan:** Scanning of Cassette type codes to determine which types of Cassettes are used, and scanning of rows and columns in deep well plates to identify which types of plates are used (24, 48, or 96 wells). Full scan is performed only when the system is in state **Ready**.
  - **Quick scan:** Scanning of Cassette type codes to determine which type of Cassettes are used. Quick scan is performed during the run to ensure that correct Cassettes are placed in the Fraction collector.
- 

### Fractionation modes to avoid spillage

Three fractionation modes are available, all of which avoid spillage between wells or tubes during fractionation:

- **Accumulator:** The accumulator is used to collect liquid during movement between wells, tubes or bottles. The liquid is then dispensed in the next well or tube. Fractionation with accumulator can be used at all flow rates.
  - **DropSync:** When using **DropSync** the sensors in the Dispenser head detect when a drop is released from the nozzle. The Dispenser head moves to the next well or tube just after a drop is released. Fractionation with **DropSync** can be used at flow rates up to 2 ml/min. If the cassettes are placed near the waste funnel the **DropSync** mode can be used at higher flow rates. Volatile solutions and solutions with low surface tension may require a lower flow.
  - **Automatic:** The fraction collector uses the Drop Sync mode for flow rates up to 2 ml/min and automatically switches to Accumulator mode for higher flow rates.
-

## Fractionation arm positions

- **Home position:** The home position is used when the fraction collector is idle. The Fractionation arm is positioned in the front of the interior of the fraction collector and the Dispenser head is positioned over the waste funnel. This position is called **Waste (Frac)** in UNICORN.
  - **Frac cleaning position:** The Frac cleaning position is used for convenient cleaning of the Dispenser head. The Fractionation arm is positioned in the front of the interior of the fractionation collector and the Dispenser head is moved to the center of the Fractionation arm.
-

## 3.2.2 Fraction collector F9-C illustrations

### Introduction

This section provides illustrations of Fraction collector F9-C. The main features and components are indicated.

### Front view

The illustration below shows the main parts of the exterior of Fraction collector F9-C.

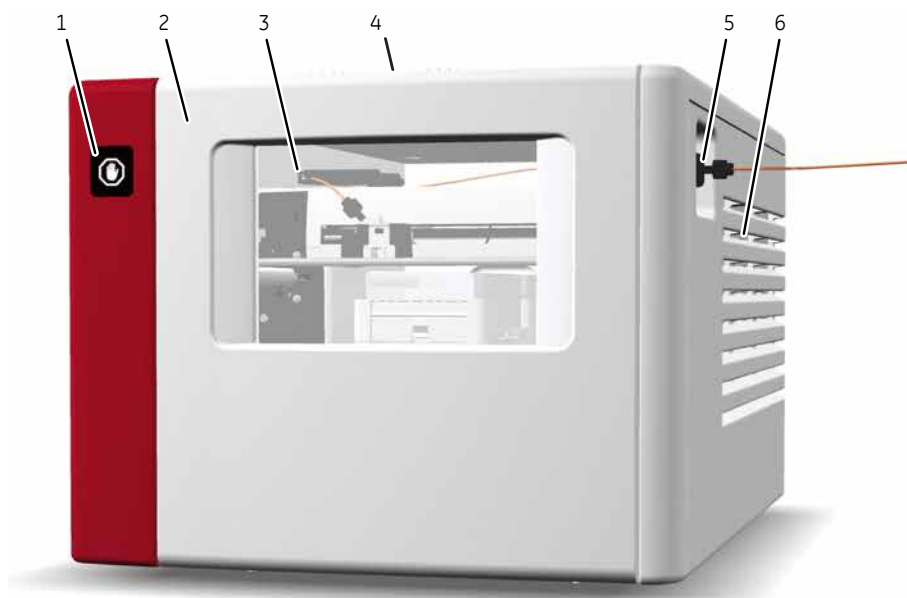

Part	Description
1	Fractionation indicator Symbol indicating that fractionation is ongoing. Do not open the door while the indicator is lit.
2	Door
3	Window
4	Door handle
5	Tubing connector for outlet valve tubing
6	Vents

## Rear view

The illustration below shows the rear view of Fraction collector F9-C.



Part	Description
1	Vents
2	UniNet-9 D-type connector (for communication and power supply)
3	Waste tube

## Interior

The illustration below shows the main parts of the interior of Fraction collector F9-C.

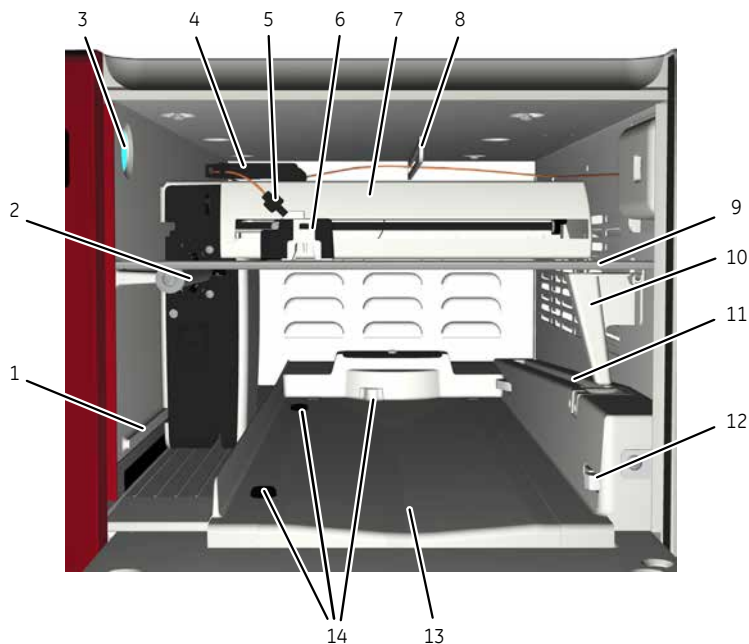

Part	Description
1	Fractionation arm guide rail
2	Fractionation arm main rail
3	Lamp
4	Tubing guide
5	Tubing connection
6	Dispenser head
7	Fractionation arm
8	Tubing guide
9	Height exclusion bar
10	Waste funnel
11	Waste tube
12	Tray catch
13	Waste groove, in case of overflow
14	Tray guides

## Dispenser head

The illustration below shows the Dispenser head of Fraction collector F9-C.

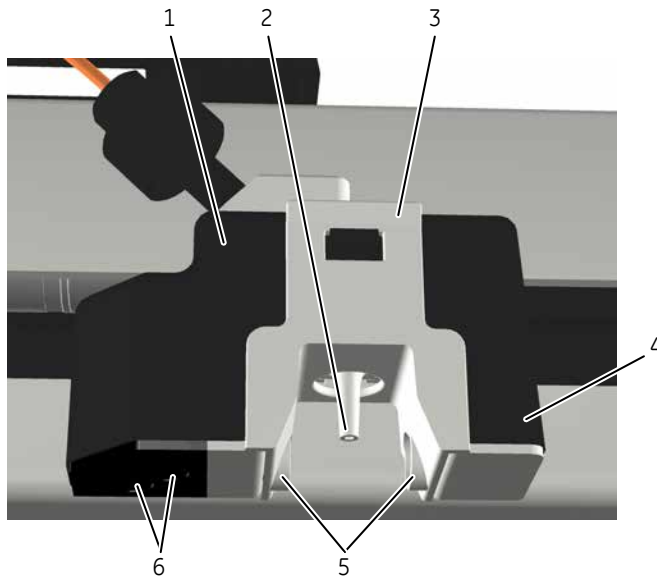

Part	Description
1	Dispenser head
2	Nozzle
3	Dispenser head cover
4	Accumulator (back part of Dispenser head)
5	Drop sync sensor
6	Type code reader

## 3.2.3 Cassettes, Cassette tray and racks

### Introduction

Fractions can be collected in deep well plates and in tubes of different sizes. A number of cassettes and racks for different tubes and deep well plates are available. The cassettes are placed on a rack with six cassette positions. The Cassette type codes are scanned by the Cassette code reader to determine the type of Cassette.

---

### Available cassettes, trays and racks

The following Cassettes and racks are available:

- Cassette 3 ml tubes (for 40 tubes)
- Cassette 5 ml tubes (for 40 tubes)
- Cassette 8 ml tubes (for 24 tubes)
- Cassette 15 ml tubes (for 15 tubes)
- Cassette 50 ml tubes (for 6 tubes)
- Cassette for deep well plate (24, 48, 96 wells)
- Cassette tray (for six cassettes)
- Rack for 50 ml tubes (for 55 tubes)
- Rack for 250 ml bottles (for 18 bottles)

For information on dimension requirements for tubes and deep well plates to be used in the fraction collector, see [Fraction collector tubes and bottles, on page 99](#) and [Deep well plates, on page 100](#) respectively.

---

### Illustrations of Fraction collector F9-C tray and racks

The illustrations below show the Cassette tray, the Rack for 50 ml tubes and the Rack for 250 ml bottles. The fronts of the tray and the racks are marked with the GE-logotype. In the Cassette tray, the cassette positions are marked 1 to 6.

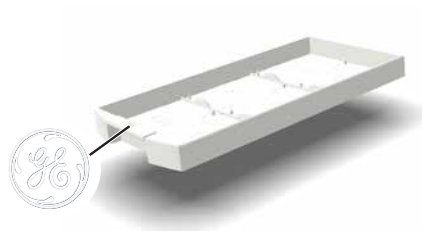

Cassette tray

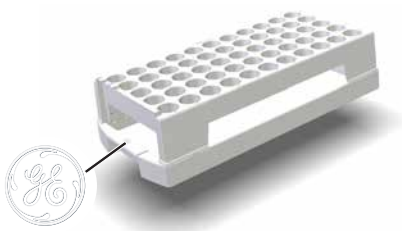

Rack for 50 ml tubes

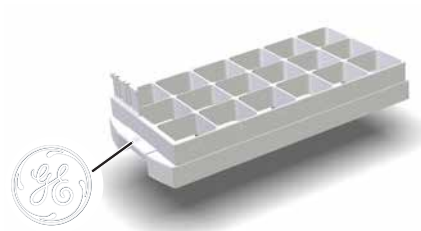

Rack for 250 ml bottles



**Note:** The tray and racks are inserted into the fraction collector with the GE-logotype facing outwards.

**Note:** Do not use the Cassette tray when a rack for tubes or bottles is placed in the fraction collector.

## Illustration of Cassettes on the Cassette tray

The illustration below shows Cassettes placed on the Cassette tray.

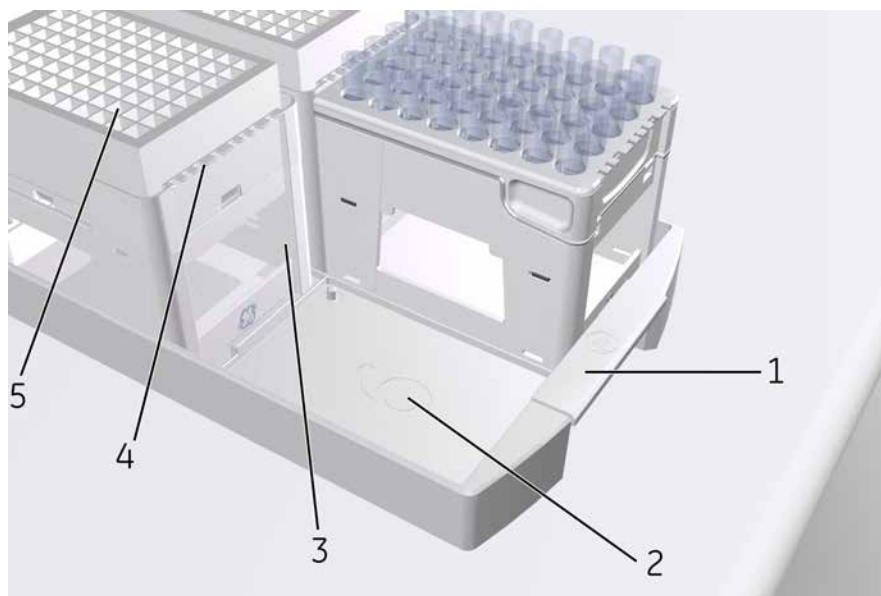

Part	Description
1	Cassette tray
2	Cassette position number
3	Cassette
4	Cassette type code
5	Tubes or deep well plates placed in a Cassette

## QuickRelease function

The Cassettes for the smaller tube sizes (3, 8, and 15 ml) have a built-in QuickRelease function. The QuickRelease function enables easy handling of tubes in the Cassettes. With the QuickRelease device in lock position the tubes are fastened in the Cassette and can easily be emptied. With the QuickRelease function in release position, the Cassette can easily be loaded with tubes and used tubes can easily be discarded.

Step	Action
1	Load the Cassette with tubes before fractionation: <ul style="list-style-type: none"><li>• Pull the QuickRelease device to the release position.</li><li>• Load the Cassette with tubes, and press the QuickRelease device to the locked position.</li></ul>



Release position

Locked position

3	After fractionation, pull the QuickRelease device to the release position and remove the tubes containing the fractions of interest.
---	--

**Step Action**

- 4 Empty and discard the remaining tubes:
- Press the QuickRelease device to the lock position, and empty the remaining tubes.
  - Pull the QuickRelease device to the release position, and discard the tubes.



Empty the tubes



Discard the tubes

## Fraction collector tubes and bottles

The tubes and bottles used in Fraction collector F9-C must fulfill the requirements listed in the table below. Examples of manufacturers are also listed in the table.

Tube or bottle size (ml)	Diameter (mm)		Height (mm)		Examples of manufacturers
	Min.	Max.	Min.	Max.	
3	10.5	11.5	50	56	NUNC™
5	10.5	12	70	76	VWR™
8	12	13.3	96	102	BD™ Biosciences, VWR
15	16	17	114	120	BD Biosciences
50	28	30	110	116	BD Biosciences
250 ml bottle	L: 55 W: 55 <sup>1</sup>	L: 64.5 W: 64 <sup>1</sup>	-	121	Nalgene™, Kautex™

<sup>1</sup> Length and width of the rectangular bottle base

### Maximum flow rate

Fraction collection can be performed at different maximum flow rates depending on the size of the tubes that are used. The table below lists the maximum flow rates for the Fraction collector tubes.

Tube size [ml]	Maximum flow rate [ml/min]
3	15
8	25
15	50
50	150
250	150

## Deep well plates

### Requirements

The deep well plates used in Fraction collector F9-C must fulfill the requirements listed in the table below.

Property	Specification
No. of wells	24, 48, or 96
Shape of wells	Square, not cylindrical
Well volume	10, 5, or 2 ml

### Approved deep well plates

The plates listed in the table below are tested and approved by GE to be used with Fraction collector F9-C.

Plate type	Manufacturer	Part no.
96 deep well plate	GE	7701-5200 (Whatman™)
	BD Biosciences	353966
	Greiner Bio-One	780270
	Porvair Sciences	219009
	Seahorse Bioscience™	S30009
	Eppendorf™	951033405/ 0030 501.306
48 deep well plate	GE	7701-5500 (Whatman)
	Seahorse Bioscience	S30004

Plate type	Manufacturer	Part no.
24 deep well plate	GE	7701-5102 (Whatman)
	Seahorse Bioscience	S30024

### Maximum flow rate

Fraction collection can be performed at different maximum flow rates depending on what type of deep well plates that are used. The table below lists the maximum flow rates for the different plate types.

Plate type	Maximum flow rate (ml/min)
96 deep well plate	10
48 deep well plate	15
24 deep well plate	25

## 3.2.4 Connect tubing to the ÄKTA pure instrument

### Connect tubing

Fraction collector F9-C is delivered with all internal tubing in place. The tubing between the fraction collector and purification instrument need to be installed.

Follow the instructions in the table below to connect the tubing from the ÄKTA pure instrument to the fraction collector.

Step	Action
1	Connect the tubing <b>Frac</b> to the <b>Frac</b> port on the outlet valve on the ÄKTA pure instrument.
2	Connect the other end of the <b>Frac</b> tubing to the inlet port on the fraction collector.

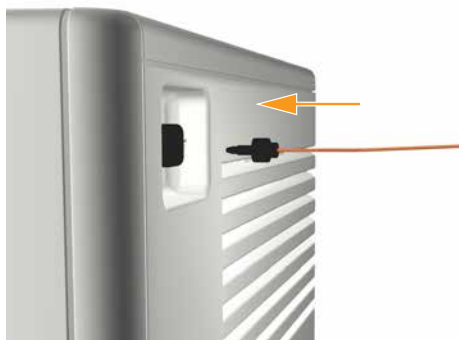

3	Adjust the delay volume setting in UNICORN, see <a href="#">Section 9.8.8 System settings - Tubing and Delay volumes, on page 459</a> for more details.
---	---

## 3.3 Fraction collector F9-R

### About this section

This section shows an overview of Fraction collector F9-R.

Technical details are found in the ÄKTA pure *User manual* and ÄKTA avant *User manual*.

---

### Function

The fraction collector collects fractions from ÄKTA pure purification runs.

The fraction collector can be used for:

- Fixed volume fractionation
- Peak fractionation
- Combined fixed volume fractionation and peak fractionation

Fraction collector F9-R has the following function for reducing sample spill during fractionation:

- Drop Sync
- 

### Front view illustration

The illustration below shows the main parts of the Fraction collector.

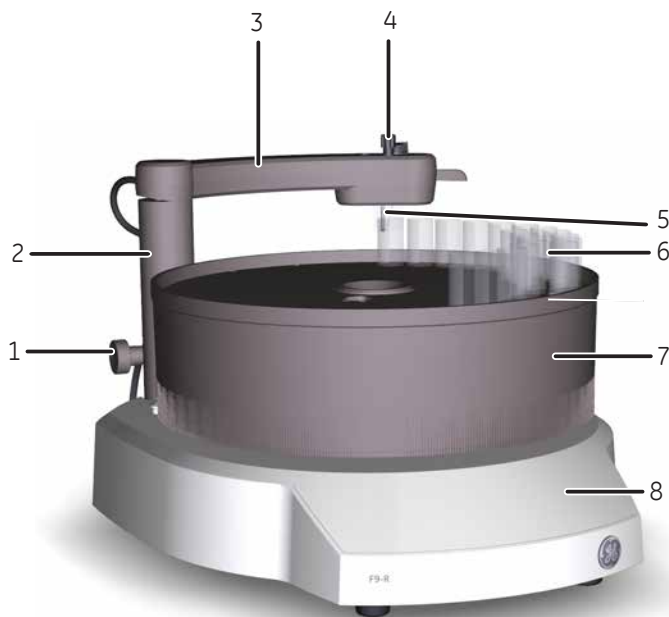

Part	Function
1	Lock knob
2	Stationary part of delivery arm
3	Delivery arm
4	Tubing connector
5	Tube sensor
6	Collection tubes
7	Tube rack
8	Base unit

### Connector panel illustration

The illustration below shows the main parts of the connector panel on the fraction collector.



Part	Function
1	Node ID switch
2	UniNet-9 F-type connector (for communication and power supply)



## Available tubes

For Fraction collector F9-R the fractions are collected in tubes of different sizes.

Tubes with the following diameter can be used with Fraction collector F9-R:

- 12 mm
- 18 mm
- 30 mm

The tubes can have a tube length between 50-180 mm.

## Illustration of the Fraction collector F9-R Tube rack

Each tube rack is made up of a combination of a Bowl, Tube support, Tube guide and Tube holder. For more information on the assembly of the tube rack, see [Assemble the Tube rack, on page 199](#). For information on which Tube rack to use, see [Tube rack inserts, on page 200](#).

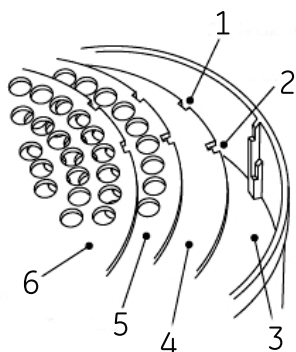

Part	Function
1	Single cutout
2	L-shaped cutout
3	Bowl
4	Tube support
5	Tube guide
6	Tube holder

**Note:** Note that the tube guide has both single and L-shaped cutouts, while the tube holder only has single cutouts. See [Single and L-shaped cutouts, on page 200](#) for more information.

## Connect tubing to ÄKTA pure

Step	Action
------	--------

1	Lift out the Tubing holder (4) from the Delivery arm (1).
---	---

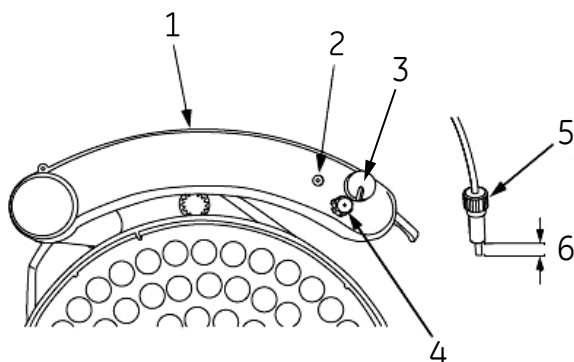

2	Loosen the nut of the Tubing holder. Do not remove the Tubing holder nut (5) from the Tubing holder.
---	--

3	Insert the tubing through the Tubing holder.
---	--

4	Place the Tubing holder with the tubing over the Tube adjustment cavity (2) of the Delivery arm. Push the tubing down against the bottom of the Tube adjustment cavity, and then fingertighten the Tubing holder nut. This ensures the correct length of the exposed tubing end (6).
---	--

5	Re-install the tubing holder in the Delivery arm.
---	---

6	For <b>Fraction collector F9-R</b> : Connect the tubing from the fraction collector to the port <b>Frac</b> on the outlet valve.
---	--

For **Fraction collector F9-R, 2nd**: Connect the tubing from the second fraction collector to:

- port **Out 10** on Outlet valve **V9-O** or **V9H-O**
- port **Out 1** on Outlet valve **V9-Os** or **V9H-Os**

7	Adjust the delay volume setting in UNICORN to the volume of the tubing, see <a href="#">Section 9.8.8 System settings - Tubing and Delay volumes, on page 459</a> for more details.
---	---

## 3.4 Sample pump S9 and S9H

### Introduction

This section describes the design and function of Sample pump S9 and S9H.

### Function of the Sample pump

The Sample pump is dedicated to direct loading of sample onto a column, or to filling of sample loops or Superloops. The pump consists of two pump heads that work alternately to give a continuous, low pulsation, liquid delivery. There are two sample pump configurations available, one for ÄKTA pure 150 and one for ÄKTA pure 25. To ensure delivery of correct liquid volume, the pumps must be free from air. Each pump head is equipped with a purge valve that is used for this purpose.

The Sample pump also comprises a pressure monitor.

The table below contains the operating limits and labels of the sample pump configurations.

Configuration	Pump label	Pump type	Flow rate	Max. pressure
Sample pump <b>S9</b> , ÄKTA pure 25	<b>P9-S</b>	P9-S	0.001 to 50 ml/min	10 MPa
Sample pump <b>S9H</b> , ÄKTA pure 150	<b>P9H S</b>	P9H	0.01 to 150 ml/min	5 MPa

### Front view

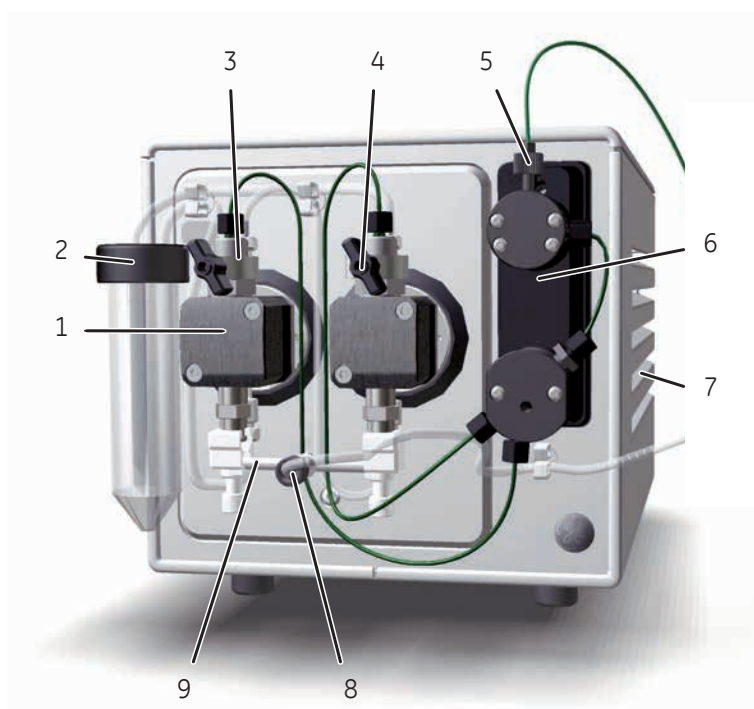

### 3 ÄKTA pure external modules

#### 3.4 Sample pump S9 and S9H

Part	Function
1	Pump head: Encapsulates the inner parts of the pump
2	Pump rinsing liquid tube holder
3	Outlet port with check valves
4	Purge valve: Used to remove air from the pump
5	Sample pump outlet port
6	Sample pressure monitor
7	Vents
8	Sample pump inlet port
9	Inlet manifold

#### Rear view

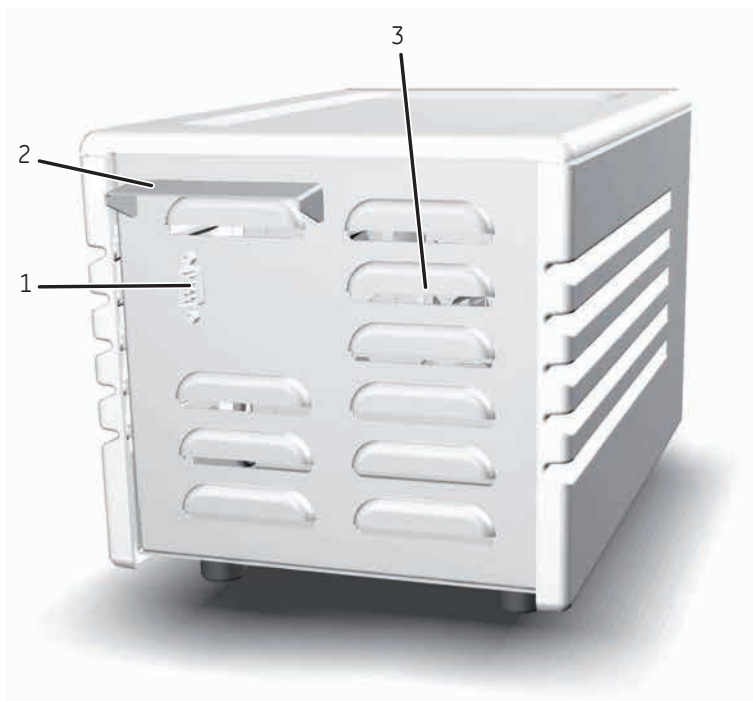

Part	Function
1	UniNet-9 type D port
2	IP cover: Protects pump electronics from liquid spill
3	Vents

## Sample pump piston rinsing system

A seal prevents leakage between the pump chamber and the drive mechanism. The seal is continuously lubricated by the presence of solvent. The pump piston rinsing system continuously flushes the low pressure chamber behind the piston with a low flow of 20% ethanol. This prevents any deposition of salts from aqueous buffers on the pistons and prolongs the working life of the seals.

For instructions on how to fill the rinsing system, see [Section 7.3.1 Change pump rinsing solution, on page 262](#)

## Illustrations of the sample pump piston rinsing system

The illustrations below show the parts, tubing and flow path of the sample pump piston rinsing system.

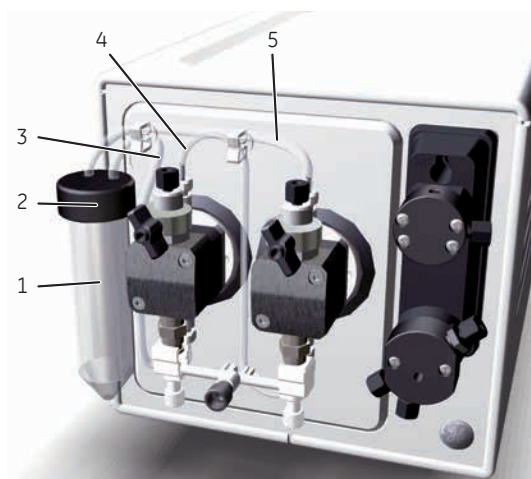

Parts and tubing

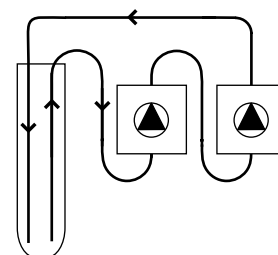

Rinsing system flow path

Part	Function
1	Pump rinsing liquid tube
2	Pump rinsing liquid tube holder
3	Inlet tubing, from the rinsing liquid tube to the left pump head (lower rinsing system connection) .
4	Tubing between the left pump head (upper rinsing system connection) and the right pump head (lower rinsing system connection).
5	Outlet tubing, from the right pump head (upper rinsing system connection) to the rinsing liquid tube.

## Connect tubing to the ÄKTA pure instrument

The table below shows recommended tubing and connectors.

Tubing label	Connection	Tubing		Connector		Tubing length (mm)
		ÄKTA pure 25	ÄKTA pure 150	ÄKTA pure 25	ÄKTA pure 150	
<b>InS</b>	Sample inlet valve port <b>Out</b> to sample pump inlet manifold	FEP o.d. 1/8", i.d. 1.6 mm	FEP o.d. 3/16", i.d. 2.9 mm	Tubing connector 5/16" with Ferrule (yellow), 1/8"	Tubing connector 5/16" with Ferrule (blue), 3/16"	580
No label	Sample container to sample pump inlet manifold (sample inlet valve not used)	FEP o.d. 1/8", i.d. 1.6 mm	FEP o.d. 3/16", i.d. 2.9 mm	Tubing connector 5/16" with Ferrule (yellow), 1/8"	Tubing connector 5/16" with Ferrule (blue), 3/16"	optional
<b>3S</b>	Sample pump pressure monitor to Inlet valve port <b>SaP</b>	PEEK, o.d. 1/16", i.d. 0.75 mm	PEEK, o.d. 1/16", i.d. 1 mm	Fingertight connector, 1/16"	Fingertight connector, 1/16"	530

**Note:** The recommended location of the sample pump is on the bench to the left of the ÄKTA instrument. If the sample pump is placed elsewhere, longer tubing may be needed.

## 3.5 I/O-box E9

### About this section

This section describes the design and the function of the I/O-box E9

---

### In this section

This section contains the following subsections:

Section	See page
3.5.1 Overview of the I/O-box	112
3.5.2 Analog connector and signals	114
3.5.3 Digital connector and signals	116
3.5.4 Connect external equipment to the I/O-box	118

---

## 3.5.1 Overview of the I/O-box

### Function of the I/O-box

The I/O-box **E9** is used to interface other equipment in order to measure parameters such as refractive index, light scattering and fluorescence. See [Requirements on connected equipment, on page 118](#) for information on requirements of the equipment that can be connected to ÄKTA pure. The I/O-box can control external equipment by a digital output signal, as well as detecting the state of them by digital inputs. It is also possible to send out internal detector signals to external equipment.

### Using two I/O-boxes

It is possible to install up to two I/O-boxes when using ÄKTA pure. If two I/O-boxes are to be used, the second I/O-box has to be configured as I/O-box E9, 2nd. The configuration is defined by the Node ID of the I/O-box. The Node ID is set by positioning the arrow of two rotating switches at the back of the I/O-box, see [Connectors, on page 113](#) and [Section 9.16 Node IDs, on page 502](#).

### Location

The illustration below shows the I/O-box, its recommended location and connection.

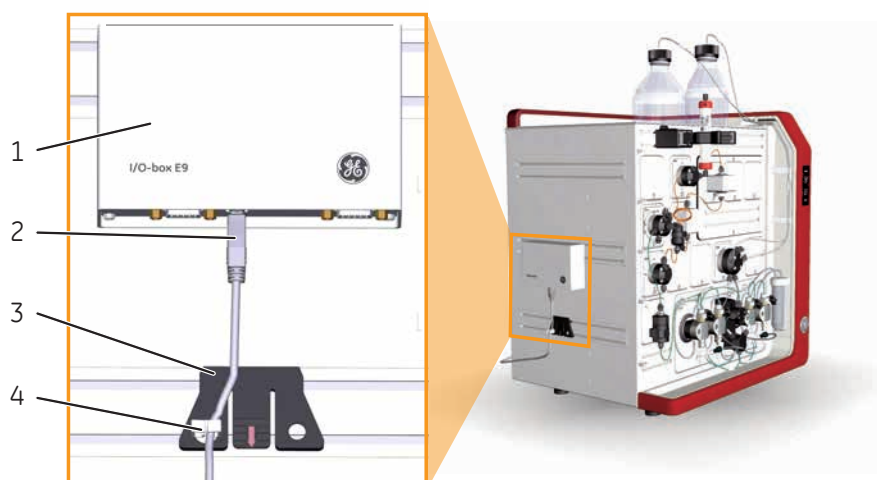

Part	Description
1	I/O-box
2	UniNet-9 F-type cable
3	Multi-purpose holder
4	Clip



## Connectors

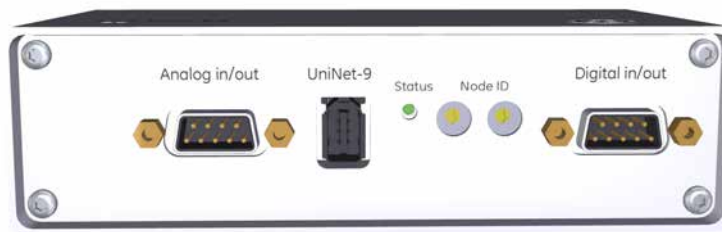

Part	Description
<b>Analog in/out</b>	Signal connector for analog input and output signals.
<b>UniNet-9</b>	Connector used to connect the I/O-box to the ÄKTA pure instrument.
<b>Status</b>	Status indicator for service purposes.
<b>Node ID</b>	Switches used to configure <b>I/O-box E9</b> as I/O-box E9 or I/O-box E9, 2nd.
<b>Digital in/out</b>	Signal connector for digital input and output signals.

## 3.5.2 Analog connector and signals

### Analog connector pins

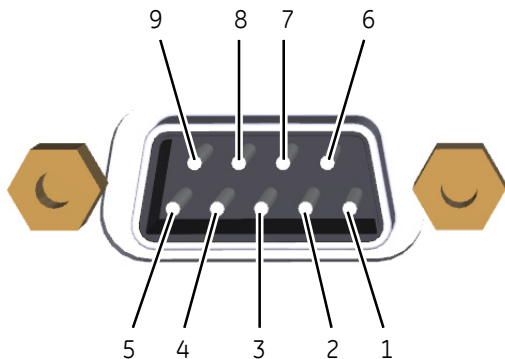

Part	Function
1	Analog in signal 1 +
2	Analog in signal 1 - (or signal ground)
3	Shield, analog in (both ports)
4	Analog in signal 2 +
5	Analog in signal 2 - (or signal ground)
6	Calibration pin for service purposes Analog out signal (1.9 V) <b>Note:</b> <i>Do not use for other purposes.</i>
7	Analog out signal 1
8	Signal ground, analog out (both ports)
9	Analog out signal 2

### Analog signals

All analog input and output signals are confined to the same **Analog in/out** connector.

## Analog input signals

There are two analog input channels from which analog input signals can be used for peak detection, or data collection in UNICORN. It is possible to auto-zero the input signals, which means that the current value will be displayed as 0 V in UNICORN. This can be done individually for the two analog input channels. The auto-zero value is saved between runs and power-offs. The auto-zero value can be reset.

Parameter	Description
Input signal range	-2000 to 2000 mV

## Analog output signals

There are two analog output channels from which analog output signals and system parameters, that is, UV, cond, conc B, temperature and pH, are transferred to the external connected equipment, for example, light scattering detectors or plotters.

Parameter	Description
Output signal range	-1000 to 1000 mV
Default output	The user defines the default output level for the selected signal.
Full scale output	The user sets the desired output signal value of, e.g., mAU, % or mS, which will corresponds to the full scale output voltage 1000 mV.
Negative full scale output	The corresponding negative full scale output value is set automatically. For example, if the full scale output is set to 2000 mAU, a UV value of 500 mAU will give an output voltage of 250 mV, and -100 mAU will give -50 mV output voltage. A signal value of 0 mAU, 0% or 0 mS will always give an output voltage of 0 mV.
Fix point	Zero is always a fix point. A desired output signal of, i.e., 0 mAU, 0% or 0 mS corresponds to an output voltage of 0 mV. At power-on, an output signal of 0 mV is transferred to the connected equipment, until the output signal range values are set.

**Note:** No warning will be displayed in UNICORN if the analog output signal exceeds the set full scale output value or is less than the set negative full scale output value.

### 3.5.3 Digital connector and signals

#### Digital connector pins

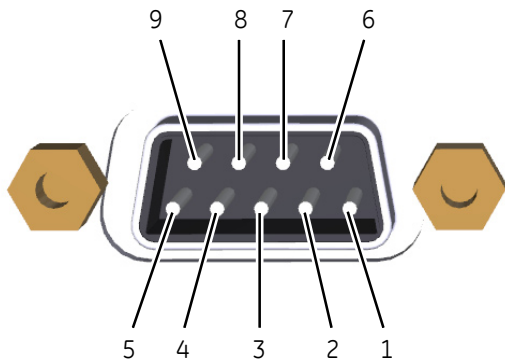

Part	Function
1	Digital in signal 1
2	Digital in signal 2
3	Digital in signal 3
4	Digital in signal 4
5	Signal ground
6	Digital out signal 1
7	Digital out signal 2
8	Digital out signal 3
9	Digital out signal 4

#### Digital signals

All digital input and output signals will be confined to the same D-sub connector and have a common ground. The four input signals will be scanned synchronously, and the outputs will be set synchronously.

#### Digital input signals

The digital in-signal can be used to monitor external equipment by registering, for example, error signals or event marks. An event mark can be used as a trigger for watches. The measured digital signals can be shown as a curve in UNICORN. The unit will handle both open/closed circuit and TTL-type voltage signals. An open circuit is interpreted as logical 1 and a closed circuit as logical 0.

**Note:** A closed circuit is always closed against signal ground.

Input connection	UNICORN interpretation
Open circuit	Logical 1
Applied voltage 3.5 to 5.0 V	
Closed circuit	Logical 0
Applied voltage 0 to 0.8 V	

## Digital output signals

The digital output signal can be used to control external equipment that can receive digital signals, such as pumps or fraction collectors. The digital output signals define an open or closed circuit, where a logical 1 will result in an open circuit and a logical 0 will give a closed circuit. The default level, 1 or 0, is set by the user. The level can be changed by instructions either manually, in **System Settings** or by a method. It is possible to send pulses from the current level, with a pulse length of 0.1 s to 10 s.

**Note:** *A closed circuit is always closed against signal ground.*

---

## 3.5.4 Connect external equipment to the I/O-box

### Requirements on connected equipment

The signal characteristics for the connected equipment are described in the following tables. All connected equipment must have a common ground.

#### Analog input

Parameter	Value
Channels	2
Range	±2000 mV
Input impedance	1 MΩ
Accuracy	±(0.1% + 0.2 mV)

#### Analog output

Parameter	Value
Channels	2
Range	±1000 mV
Input impedance	100 kΩ
Accuracy	±(0.3% + 1 mV)

#### Digital input

Parameter	Value
Channels	4
Compatibility	TTL, open/closed circuit

#### Digital output

Parameter	Value
Channels	4
Compatibility	Open/closed circuit

### Required material

The following material is required:

- Flat-blade screwdriver, 2 mm
- Shielded cable with 9 conductors, 4 to 8 mm diameter

- Wire stripping tool

## Instruction

Follow the instructions to connect one or two external cables to the supplied D-sub connectors.

Step	Action
1	Open the connector housing by removing housing screw and unlatch the housing top shell using a flat-blade screwdriver.
2	Locate the connection block mounted on the PCB board. The screw terminals has numbers corresponding to the connector contacts.

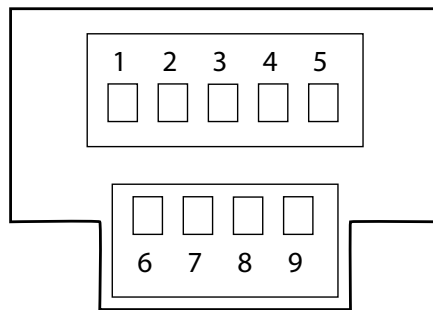

3	Strip the signal cable. <ul style="list-style-type: none"> <li>• Strip-off 50 mm of the shield insulator.</li> <li>• Strip-off 4 mm of the single conductor insulation.</li> </ul>
4	Loosen the strain relief clamp and insert the cable with the shield under the strain relief clamp. Fasten the strain relief clamp over the cable shield. <p><b>Tip:</b> The connection block can be rotated inside the housing in order to position the screw terminals for left side or right side cable entry.</p>
5	Insert and fasten the single conductors in the screw terminals.
6	Close the housing top shell with the latch and screw the housing together.

## System properties

Follow the instruction to update the system properties.

Step	Action
1	Open the system properties <b>Edit</b> dialog box.
2	In the <b>Component types</b> list, click <b>Other</b> .
3	Select the <b>I/O-box (E9)</b> or <b>I/O-box 2 (E9)</b> check box in the <b>Component selection</b> list. Then click <b>OK</b> .

## System settings

Default values for digital out ports, noise reduction and configuration of analog out ports can be set.

Instruction name	Description
<b>Digital out X</b>	Sets the value of the signal sent out by digital port number X to either 0 or 1. The default value is 1.
<b>Noise reduction analog in X</b>	Filters the noise in the analog signal in port number X.
<b>Alarm analog in X</b>	Enables or disables the alarm for the analog signal in port number X. When enabled, it sets the alarm limits for the analog signal. If the alarm is enabled and the analog signal falls outside the set limits, an alarm will be triggered and the method will be paused.
<b>Alarm digital in X</b>	Enables or disables the alarm for the signal in digital port number X. The alarm can be triggered by either of the signal values, 0 or 1. If the alarm is enabled and the condition set in 'Value' occurs, an alarm will be triggered and the method will be paused.
<b>Configure analog out X</b>	Enables the user to send one of the pre-defined signals (UV signal, conductivity, temperature, pH or concentration of eluent B) to the analog out port number X, and also to set the range of that signal.

**Note:** The delay volume has to be updated if an external component is added to the flow path.



## 3.6 Connection of external modules

### Introduction

The external modules are not installed in the instrument cabinet, but are connected via a UniNet-9 cable at the back of the system. It is possible to install up to six external modules with F-type connectors and up to two external modules with D-type connectors at the same time.

Some of the external modules are also connected to the ÄKTA pure instrument by tubing. See the appropriate section in [Chapter 3 ÄKTA pure external modules, on page 86](#) for detailed instructions on how to install this tubing, if applicable.

### F-type and D-type connectors

The illustrations below show the F-type and D-type connectors.



F-type



D-type

### Constraints

The table below indicates usage constraints for the different external modules.

External module	Connector	Constraints
I/O-box E9	F-type	I/O-box E9 has no constraints.
I/O-box E9, 2nd	F-type	I/O-box E9, 2nd requires I/O-box E9.
External air sensor L9	F-type	External air sensor L9 has no constraints.
External air sensor L9, 2	F-type	External air sensor L9, 2 requires External air sensor L9.
External air sensor L9, 3	F-type	External air sensor L9, 3 requires External air sensor L9, 2.
External air sensor L9, 4	F-type	External air sensor L9, 4 requires External air sensor L9, 3.
Fraction collector F9-C	D-type	Fraction collector F9-C requires an Outlet valve.
Fraction collector F9-R	F-type	Fraction collector F9-R requires an Outlet valve.

External module	Connector	Constraints
Fraction collector F9-R, 2nd	F-type	Fraction collector F9-R, 2nd requires Fraction collector F9-R or Fraction collector F9-C.
Sample pump S9 and S9H	D-type	Cannot be used at the same time as Mixer valve V9-M or V9H-M.

**Note:** To optimize signal quality, the total cable length connecting all external modules to the ÄKTA pure instrument should not exceed 10 m.

### ÄKTA pure connector plate

The connector plate with the UniNet-9 connectors is located on the back of the ÄKTA pure instrument.

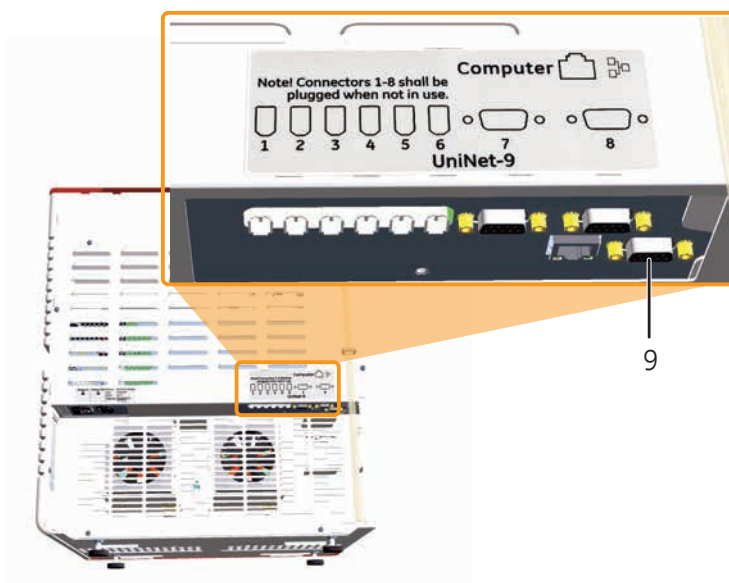

Connector	Connector name	Function
9	<b>Test</b>	Connector point for service.



#### NOTICE

Do not connect any module to the connector **Test** on the ÄKTA pure instrument.

**Note:** Plug all unused UniNet-9 ports (ports 1 to 8) on the ÄKTA pure instrument with jumpers.

**Note:** The connector **Test** should be protected by a plastic lid. Do not plug the connector with a jumper.

# 4 System configuration

## About this chapter

This chapter describes hardware configuration of the ÄKTA pure instrument and how to install optional modules and add them in UNICORN.

---

## In this chapter

This chapter contains the following sections:

Section	See page
4.1 Configuration overview	124
4.2 Configure modules	130
4.3 General system settings	145

---



## Recommended module position

Module	Recommended location	Constraints
Column valve <b>V9-C</b> or <b>V9H-C</b>	9	Column valve <b>V9-C</b> or <b>V9H-C</b> cannot be used at the same time as Column valve <b>V9-Cs</b> or <b>V9H-Cs</b> .
Column valve <b>V9-C</b> or <b>V9H-C</b> with Second column valve <b>V9-C2</b> or <b>V9H-C2</b>	8 ( <b>V9-C</b> or <b>V9H-C</b> ) 9 ( <b>V9-C2</b> or <b>V9H-C2</b> )	These positions give the shortest possible flow path.
Column valve <b>V9-Cs</b> or <b>V9H-Cs</b>	9	Column valve <b>V9-Cs</b> or <b>V9H-Cs</b> cannot be used at the same time as Column valve <b>V9-C</b> or <b>V9H-C</b> .
Conductivity monitor <b>C9</b>	7	Conductivity monitor <b>C9</b> has no constraints.
Injection valve <b>V9-Inj</b> or <b>V9H-Inj</b>	6	Core module.
Inlet valve <b>V9-IAB</b> or <b>V9H-IAB</b>	<ul style="list-style-type: none"> <li>• 4</li> <li>• 5, if Inlet valve <b>V9-IAB</b> or <b>V9H-IAB</b> is used in combination with Inlet valve <b>V9-IA</b> or <b>V9H-IA</b>.</li> </ul>	Possible combinations of inlet valves: <ul style="list-style-type: none"> <li>• Inlet valve A and Inlet valve B.</li> <li>• Inlet valve AB together with Inlet valve A or Inlet valve B.</li> <li>• One Inlet valve AB. or</li> <li>• No installed inlet valves.</li> </ul>
Inlet valve <b>V9-IA</b> or <b>V9H-IA</b>	4	
Inlet valve <b>V9-IB</b> or <b>V9H-IB</b>	5	
Sample inlet valve <b>V9-IS</b> or <b>V9H-IS</b>	8	Cannot be used at the same time as Mixer valve <b>V9-M</b> or <b>V9H-M</b> .
Inlet valve <b>V9-X1</b> or <b>V9H-X1</b>	None	Inlet valve <b>V9-X1</b> or <b>V9H-X1</b> has no constraints, and has no support in the method phases.
Inlet valve <b>V9-X2</b> or <b>V9H-X2</b>	None	Inlet valve <b>V9-X2</b> or <b>V9H-X2</b> requires Inlet valve <b>V9-X1</b> or <b>V9H-X1</b> , respectively. It has no support in the method phases.
Loop valve <b>V9-L</b> or <b>V9H-L</b>	8	Loop valve <b>V9-L</b> or <b>V9H-L</b> has no constraints, but is connected with the injection valve by replacing the loop.
Mixer <b>M9</b>	0	Core module.
Mixer valve <b>V9-M</b> or <b>V9H-M</b>	3	Cannot be used at the same time as Sample pump <b>S9</b> or <b>S9H</b> .

Module	Recommended location	Constraints
Outlet valve <b>V9-Os</b> or <b>V9H-Os</b>	1	Cannot be used at the same time as Outlet valve <b>V9-O</b> or <b>V9H-O</b> .
Outlet valve <b>V9-O</b> or <b>V9H-O</b>	1	Cannot be used at the same time as Outlet valve <b>V9-Os</b> or <b>V9H-Os</b> .
pH valve <b>V9-pH</b> or <b>V9H-pH</b>	2	pH valve shall always be connected after the column due to pressure constraints and fractionation control. The delay volume calculations will be effected if the valve is located elsewhere. Normally it is situated between the monitor and the Outlet valve.
Versatile valve <b>V9-V</b> or <b>V9H-V</b>	None	<ul style="list-style-type: none"> <li>Versatile valve <b>V9-V</b> or <b>V9H-V</b> has no constraints.</li> <li>Versatile valve <b>2</b> requires Versatile valve <b>V9-V</b>.</li> <li>Versatile valve <b>3</b> requires Versatile valve <b>2</b>.</li> <li>Versatile valve <b>4</b> requires Versatile valve <b>3</b>.</li> </ul>
Versatile valve <b>2</b>		
Versatile valve <b>3</b>		
Versatile valve <b>4</b>		
UV monitor <b>U9-M</b>	10	UV monitor <b>U9-M</b> cannot be used at the same time as UV monitor <b>U9-L</b> .  <b>Note:</b> <i>UV monitor U9-L, 2nd can be used at the same time as UV monitor U9-M.</i>
UV monitor <b>U9-L</b>	11	UV monitor <b>U9-L</b> : <ul style="list-style-type: none"> <li>Cannot be used at the same time as UV monitor <b>U9-M</b>.</li> <li>Requires the Multi-module panel.</li> </ul> <b>Note:</b> <i>UV monitor U9-L, 2nd can be used at the same time as UV monitor U9-L.</i>
UV monitor <b>U9-L, 2nd</b>	None	UV monitor <b>U9-L, 2nd</b> requires UV monitor <b>U9-L</b> or UV monitor <b>U9-M</b> .

## Install the modules

Detailed information about installation of the modules is found in [Chapter 2 The ÄKTA pure instrument, on page 13](#) and [Chapter 3 ÄKTA pure external modules, on page 86](#).

Below is a quick guide of how to perform a module hardware installation.

Step	Action
1	Switch off the power.
2	Check/set node ID. See NodeID list.
3	Install the module.
4	Connect tubing.

## Edit system properties

When a new module has been installed, the system properties have to be updated in UNICORN. The system will restart automatically when the configuration has been changed in **System Properties** and the system can be reconnected.

The following instruction gives a general description of how to update the system properties in UNICORN.

**Step**      **Action**

- 1
- In the **Administration** module, choose **Tools:System Properties** or click the **System Properties** icon to open the dialog.  
*Result:* The **System Properties** dialog is displayed.
  - Select the system of interest in the **System Properties** dialog.
  - Click the **Edit** button.

**Note:**

*Only active systems can be edited.*

*Result:* The **Edit** dialog is displayed.

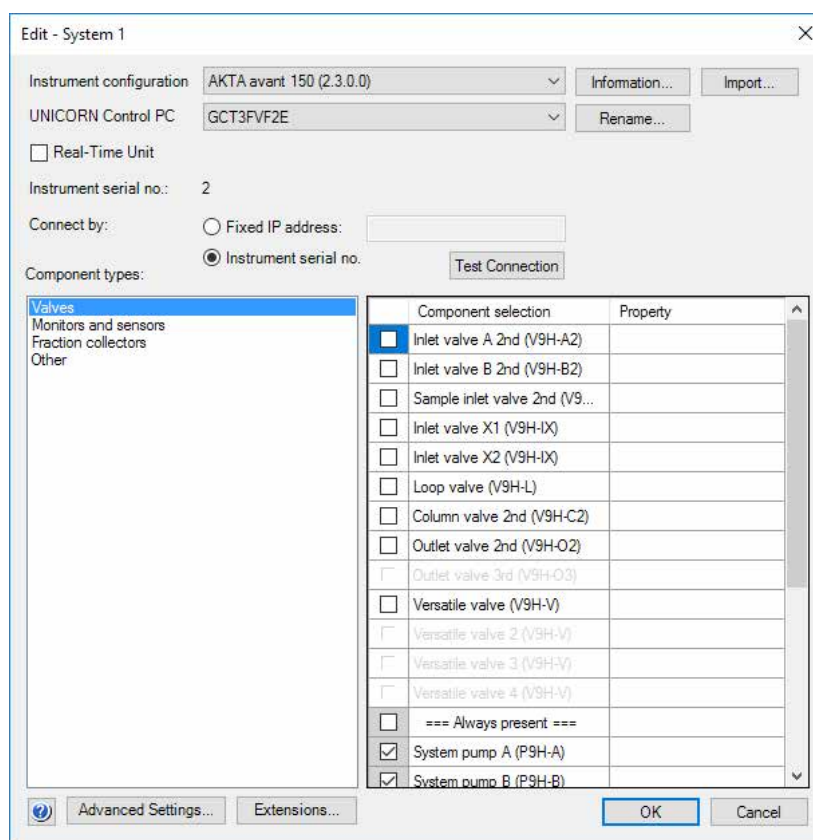

- 2
- Select the component type of interest from the **Component types** list.  
*Result:* All available components are shown in the **Component selection** list.
- Click the checkbox to select the added component.
  - When applicable, choose the appropriate **Property**.

**Note:**

*Instrument modules are referred to as **Components** in UNICORN.*

- 3
- Click the **OK** button to apply the changes.



There are five main types of modules (named components in UNICORN) to select from:

- Valves and pumps
- Monitors and sensors
- Fraction collectors
- Other (e.g., I/O-box)
- Core components (always present)

Multiple choices are not shown unless a component has been selected. The second component is only available when the first has been selected. The selection made is reflected in which instructions and phase properties that are available.

## Edit system settings

It may be necessary to edit the **System Settings** when the configuration of the system is changed. For example, if the change in configuration affects the delay volume following the UV monitor (or other monitor connected via the I/O-box) the appropriate system settings for **Tubing and delay volumes** have to be updated. This is to ensure that the fractions marked in the chromatogram corresponds to the actual collected fractions.

Other system settings might also need to be edited for some optional modules.

The **Edit** dialog in which to edit the system settings is shown below.

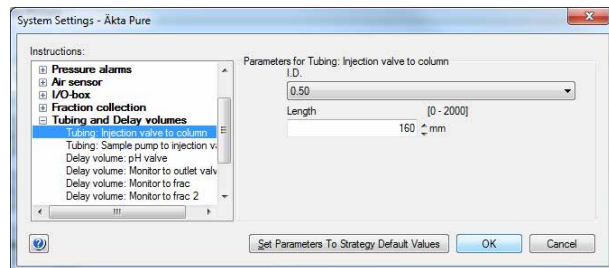

In this dialog it is possible to set the parameters for the available instructions.

All system settings available for ÄKTA pure are found in [Section 9.8 System settings, on page 448](#).

## 4.2 Configure modules

### In this section

This section describes the software configuration that must be set for the individual modules that are to be used for a specific run.

A general description of how to update the system properties are found in [Edit system properties, on page 127](#).

A general description of how to edit system settings are found in [Edit system settings, on page 129](#).

Section	See page
4.2.1 Configuration of inlet valves	131
4.2.2 Configuration of Mixer valves	132
4.2.3 Configuration of Loop valves	133
4.2.4 Configuration of column valves	134
4.2.5 Configuration of Versatile valves	136
4.2.6 Configuration of pH valves	137
4.2.7 Configuration of outlet valves	138
4.2.8 Configuration of UV monitors	139
4.2.9 Configuration of Conductivity monitor	140
4.2.10 Configuration of external air sensors	141
4.2.11 Configuration of fraction collectors	142
4.2.12 Configuration of I/O-box	144

## 4.2.1 Configuration of inlet valves

### System properties

Follow the instruction below to update the system properties.

- | Step | Action   |
|------|--|
| 1    | Open the system properties <b>Edit</b> dialog.                       |
| 2    | Select <b>Valves and pumps</b> from the <b>Component types</b> list. |
| 3    | Select components and properties according to the following table:   |

Valve	Component selection	Property
Inlet valve <b>V9-IA</b>	<b>Inlet A</b>	<b>V9-IA (7-ports)</b>
Inlet valve <b>V9H-IA</b>		<b>V9H-IA (7-ports)</b>
Inlet valve <b>V9-IB</b>	<b>Inlet B</b>	<b>V9-IB (7-ports)</b>
Inlet valve <b>V9H-IB</b>		<b>V9H-IB (7-ports)</b>
Inlet valve <b>V9-IAB</b> or <b>V9H-IAB</b> used for inlet A	<b>Inlet A</b>	<b>V9-IAB part A (2-ports)</b> or <b>V9H-IAB part A (2-ports)</b>
Inlet valve <b>V9-IAB</b> or <b>V9H-IAB</b> used for inlet B	<b>Inlet B</b>	<b>V9-IAB part B (2-ports)</b> or <b>V9H-IAB part B (2-ports)</b>
Sample inlet valve <b>V9-IS</b>	<b>Sample inlet V9-IS</b>	N/A
Sample inlet valve <b>V9H-IS</b>	<b>Sample inlet V9H-IS</b>	N/A
Inlet valve <b>V9-IX</b>	<b>Inlet valve X1 (V9-IX)</b>	N/A
Inlet valve <b>V9H-IX</b>	<b>Inlet valve X1 (V9H-IX)</b>	N/A
Inlet valve <b>V9-IX</b> , 2nd	<b>Inlet valve X2 (V9-IX)</b>	N/A
Inlet valve <b>V9H-IX</b> , 2nd	<b>Inlet valve X2 (V9H-IX)</b>	N/A

### System settings

There are no system settings available for the inlet valves.

## 4.2.2 Configuration of Mixer valves

### System properties

Follow the instruction below to update the system properties.

Step	Action
1	Open the system properties <b>Edit</b> dialog.
2	Select <b>Valves and pumps</b> from the <b>Component types</b> list.
3	Select <b>Mixer valve (V9-M)</b> or <b>Mixer valve (V9H-M)</b> in the <b>Component selection</b> list.

### System settings

The flow rate for Mixer by-pass wash can be set.

Instruction name	Description
<b>Mixer by-pass wash settings</b>	Sets the flow rate used during <b>Mixer by-pass wash</b> and defines wash volumes for mixer by-pass wash options.  <b>Note:</b> <i>The flow rate should not exceed 10 ml/min if narrow inlet tubing (i.d. 0.75 mm) is used.</i>

## 4.2.3 Configuration of Loop valves

### System properties

Follow the instruction below to update the system properties.

Step	Action
1	Open the system properties <b>Edit</b> dialog.
2	Select <b>Valves and pumps</b> from the <b>Component types</b> list.
3	Select <b>Loop valve (V9-L)</b> or <b>Loop valve (V9H-L)</b> in the <b>Component selection</b> list.

### System settings

The flow rate for Loop wash can be set.

Instruction name	Description
<b>Loop wash settings</b>	Sets the flow rate used during <b>Loop wash</b> . <b>Note:</b> <i>The flow rate should not exceed 10 ml/min if narrow inlet tubing (i.d. 0.75 mm) is used.</i>

## 4.2.4 Configuration of column valves

### System properties

Follow the instruction below to update the system properties.

- | Step | Action   |
|------|--|
| 1    | Open the system properties <b>Edit</b> dialog.                       |
| 2    | Select <b>Valves and pumps</b> from the <b>Component types</b> list. |
| 3    | Select components and properties according to the following table:   |

Valve	Component selection	Property
Column selection valve <b>V9-C</b>	<b>Column valve</b>	<b>V9-C (5-columns)</b>
Column selection valve <b>V9H-C</b>	<b>Column valve</b>	<b>V9H-C (5-columns)</b>
Second column selection valve <b>V9-C2</b>	<b>Column valve</b>	<b>V9-C2 (5-columns)</b>
Second column selection valve <b>V9H-C2</b>	<b>Column valve</b>	<b>V9H-C2 (5-columns)</b>
Column control valve <b>V9-Cs</b>	<b>Column valve</b>	<b>V9-Cs (1-column)</b>
Column control valve <b>V9H-Cs</b>	<b>Column valve</b>	<b>V9H-Cs (1-column)</b>

### System settings

After selecting Column valve **V9-Cs**, **V9H-Cs** or no column valve, in UNICORN, the tube length has to be defined.

The instructions **Tubing: Injection valve to column** and **Tubing: Sample pump to injection valve** are used in calculations of pre-column pressure when Column valve **V9-C** or **V9H-C** (5-columns) is NOT mounted onto the system. In such cases, there is no pre-column pressure sensor present. The estimated pre-column pressure is calculated using the measured system pressure and the length of the tubing between the system pressure sensor and the Column.

The instructions are available only when the Column valve **V9-C** or **V9H-C** (5-columns) is not selected in the component list. The instruction **Tubing: Sample pump to injection valve** is in addition only available if the sample pump is selected in the list.

Follow the instructions below to set the tube length between the Injection valve and the Column and between the sample pump and the injection valve.

- | Step | Action  |
|------|---|
| 1    | <ul style="list-style-type: none"> <li>In the <b>System Control</b> module, choose <b>System:Connect to Systems</b> or click the <b>Connect to Systems</b> icon.</li> </ul> <p><i>Result:</i> The <b>Connect to Systems</b> dialog opens.</p> |

**Step**      **Action**

---

- 2
- Select a system.
  - Select **Control** mode.
  - Click **OK**.

*Result:* The selected instrument can now be controlled by the software.

- 3
- Select **Tubing and Delay Volumes** and select **Tubing: Injection valve to column**.
  - Select the **I. D.** from the drop-down list.
  - Type in the length of the tube in the **Length** field and click **OK**.

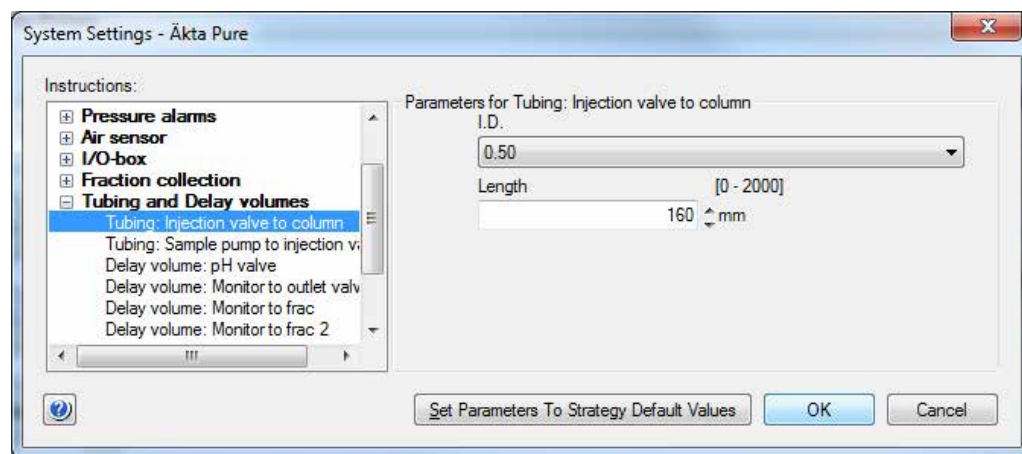

- 4      Perform step 3 for the instruction **Tubing: Sample pump to injection valve**.
- 

**Note:** The built-in pressure sensors for Column valves **V9-C** and **V9H-C** have to be re-calibrated after installation. See [Calibrate the monitors, on page 305](#).

**Note:** A Pre-Column pressure alarm shall always be set to protect the column, see [Section 5.6 Pressure alarms, on page 176](#). Column valve **V9-Cs** and **V9H-Cs** does not contain pressure monitors. See [Section 5.6 Pressure alarms, on page 176](#) for how to protect columns when not using Column valves **V9-C** and **V9H-C**.

---

## 4.2.5 Configuration of Versatile valves

### System properties

Follow the instruction below to update the system properties.

Step	Action
1	Open the system properties <b>Edit</b> dialog.
2	Select <b>Valves and pumps</b> from the <b>Component types</b> list.
3	Select <b>Versatile valve (V9-V)</b> , <b>Versatile valve 2 (V9-V)</b> , <b>Versatile valve 3 (V9-V)</b> or <b>Versatile valve 4 (V9-V)</b> in the <b>Component selection</b> list.

### System settings

If the valve is placed in the flow path between the UV monitor and the outlet valve, the delay volume must be set. See [Check/Set delay volume, on page 145](#).



## 4.2.6 Configuration of pH valves

### System properties

Follow the instruction below to update the system properties.

Step	Action
1	Open the system properties <b>Edit</b> dialog.
2	Select <b>Valves and pumps</b> from the <b>Component types</b> list.
3	Select <b>pH valve (V9-pH)</b> or <b>pH valve (V9H-pH)</b> in the <b>Component selection</b> list.

### System settings

If the valve is placed in the flow path between the UV monitor and the outlet valve, the delay volume must be set. See [Check/Set delay volume, on page 145](#).

**Note:** *It is recommended not to alter the default values for restrictor and pH cell delay volumes when standard modules and standard tubing for flow restrictor are used.*

## 4.2.7 Configuration of outlet valves

### System properties

Follow the instruction below to update the system properties.

- | Step | Action   |
|------|--|
| 1    | Open the system properties <b>Edit</b> dialog.                       |
| 2    | Select <b>Valves and pumps</b> from the <b>Component types</b> list. |
| 3    | Select components and properties according to the following table:   |

Valve	Component selection	Property
Outlet fractionation valve <b>V9-O</b>	<b>Outlet valve</b>	<b>V9-O (10-outlets)</b>
Outlet fractionation valve <b>V9H-O</b>	<b>Outlet valve</b>	<b>V9H-O (10-outlets)</b>
Outlet control valve <b>V9-Os</b>	<b>Outlet valve</b>	<b>V9-Os (1-outlet)</b>
Outlet control valve <b>V9H-Os</b>	<b>Outlet valve</b>	<b>V9H-Os (1-outlet)</b>

### System settings

If the valve is not placed in the recommended position using the standard tubing kit, the delay volume must be set. See [Check/Set delay volume, on page 145](#).

## 4.2.8 Configuration of UV monitors

### Using two UV monitors

The UV monitor **U9-L** module can be used in two configurations, UV monitor **U9-L** and UV monitor **U9-L, 2nd**. The configuration is defined by the module's Node ID.

It is possible to use two UV monitors in ÄKTA pure, in the following combinations:

- UV monitor **U9-M** together with UV monitor **U9-L, 2nd**
- UV monitor **U9-L** together with UV monitor **U9-L, 2nd**

UV monitor **U9-L, 2nd** can be located anywhere in the flow path and is therefore shown in the **Process Picture** as a component without a fixed place. This means that it is possible to place **U9-L, 2nd** before the other UV monitor in the flow path.

**Note:** If **U9-L, 2nd** is placed on the high pressure side of the column, pressure limits have to be considered. See [UV monitor options, on page 416](#) for pressure limits.

### System properties

Follow the instruction below to update the system properties.

Step	Action
1	Open the system properties <b>Edit</b> dialog.
2	Select <b>Monitors and sensors</b> from the <b>Component types</b> list.
3	Select components and properties according to the following table:

Monitor	Component selection	Property
UV monitor <b>U9-L</b>	<b>UV monitor</b>	<b>U9-L (fixed)</b>
UV monitor <b>U9-M</b>	<b>UV monitor</b>	<b>V9-M (variable)</b>
UV monitor <b>U9-L, 2nd</b>	<b>UV monitor 2nd (U9-L)</b>	N/A

### System settings

If the monitor is not placed in the recommended position using the standard tubing kit, the delay volume must be set. See [Check/Set delay volume, on page 145](#).

For UV monitor **U9-L** the flow cell length must be set. This is done as a calibration. See [Perform the calibration, on page 313](#).

## 4.2.9 Configuration of Conductivity monitor

### System properties

Follow the instruction below to update the system properties.

Step	Action
1	Open the system properties <b>Edit</b> dialog.
2	Select <b>Monitors and sensors</b> from the <b>Component types</b> list.
3	Select <b>Conductivity monitor (C9)</b> in the <b>Component selection</b> list.

### System settings

If the monitor is placed in the flow path between the UV monitor and the outlet valve, the delay volume must be set. See [Check/Set delay volume, on page 145](#).

## 4.2.10 Configuration of external air sensors

### System properties

Follow the instruction below to update the system properties.

Step	Action
1	Open the system properties <b>Edit</b> dialog.
2	Select <b>Monitors and sensors</b> from the <b>Component types</b> list.
3	Select <b>External air sensor (L9)</b> in the <b>Component selection</b> list, or the appropriate component if multiple external air sensors are used.
4	Select <b>Property</b> according to where the air sensor is placed.

**Note:**

*The available system properties are the same, regardless of which type of air sensor that is used, L9-1.2 or L9-1.5.*

### System settings

The sensitivity of the air sensor can be set.

Parameter	Air volume detected		Usage
	ÄKTA pure 25	ÄKTA pure 150	
Normal (default)	30 µl	100 µl	Detect empty buffer/sample vessels
High	10 µl	30 µl	Detect even small air bubbles

**Note:** *The sensitivity should be set to **Normal** when the air sensor is located before the System pump (**Air sensor ext - Before pump A** or **Air sensor ext - Before pump B**). Due to higher pressure and risk of small air bubbles, the sensitivity should be set to **High** when the air sensor is located after the Injection valve (**Air sensor ext - after Injection valve**).*

## 4.2.11 Configuration of fraction collectors

### System properties

Follow the instruction below to update the system properties.

Step	Action
------	--------

- |   |   |
|---|---|
| 1 | Open the system properties <b>Edit</b> dialog.                          |
| 2 | Select <b>Fraction collectors</b> from the <b>Component types</b> list. |
| 3 | Select components and properties according to the following table:      |

Fraction collector	Component selection	Property
Fraction collector F9-C	<b>Fraction collector</b>	<b>Fraction collector F9-C</b>
Fraction collector F9-R	<b>Fraction collector</b>	<b>Fraction collector F9-R</b>
Fraction collector F9-R, 2nd	<b>Fraction collector 2 (F9-R)</b>	N/A

**Note:** *Fraction collector 2* is only available in the **Component selection** list if **Fraction collector** is already selected.

### System settings

If non-standard tubing is used between the outlet valve and the fraction collector, the delay volume must be set. See [Check/Set delay volume, on page 145](#).

Fraction settings and numbering mode can be set.

#### Fraction collector F9-C

Instruction name	Description
Fractionation settings	<b>Fractionation settings</b> comprises fractionation mode and fractionation order. <b>Fractionation mode</b> ( <b>Automatic</b> , <b>Accumulator</b> or <b>DropSync</b> ). <b>Fractionation order</b> ( <b>Row-by-row</b> , <b>Column-by-column</b> , <b>Serpentine-row</b> , <b>Serpentine-column</b> ). For fractionation mode <b>DropSync</b> , only the <b>Serpentine</b> option is available.
Last tube filled	<b>Last tube filled:</b> Action when last tube is filled (pause, direct the flow to one of outlets or direct the flow to waste).
Cassette configuration	<b>Cassette configuration:</b> <b>Automatic</b> or <b>Manual</b> configuration. If <b>Automatic</b> is selected, a Quick scan or a Full scan will be performed when the door of the fraction collector is closed to determine which type of cassettes and plates are used. If <b>Manual</b> is selected, used plates and tubes in each tray position are entered.

Instruction name	Description
Fraction collector lamp	<b>Fraction collector lamp:</b> Lamps in the fraction collector chamber on or off.
Peak fractionation parameters	The <b>Peak fractionation parameters</b> set the detection parameters for peak collection, that is they decide when a peak starts and ends. This information is used by the instructions <b>Peak fractionation</b> and <b>Peak frac in outlet valve</b> in order to start/end the peak collection.

#### Fraction collector F9-R

Instruction name	Description
Fractionation settings	<b>Drop sync</b> synchronises tube change to drop release. The available settings are on or off. It is recommended to use <b>Drop sync</b> for flow rates below 2 ml/min. Higher flow rates can however be used, depending on the properties (for example viscosity) of the liquid.
Fractionation numbering mode	Determines whether the fraction number is reset at the end of a method or not.  <b>Note:</b> <i>The default setting is <b>Reset</b>.</i>
Fractionation settings frac 2	<b>Drop sync</b> on or off. It is recommended to use this setting for flow rates below 2 ml/min. Higher flow rates can be however be used, depending on the properties (e.g. viscosity) of the liquid.
Fractionation numbering mode frac 2	Determines whether fraction number for the second fraction collector is reset at the end of a method or not.  <b>Note:</b> <i>The default setting is <b>Reset</b>.</i>
Peak fractionation parameters	<b>Peak fractionation parameters</b> sets the detection parameters for peak collection, i.e. it determines when a peak starts and ends. This information is used by the instructions <b>Peak fractionation</b> , <b>Peak fractionation frac 2</b> and <b>Peak frac in outlet valve</b> in order to start/end the peak collection.

## 4.2.12 Configuration of I/O-box

### System properties

Follow the instruction below to update the system properties.

Step	Action
1	Open the system properties <b>Edit</b> dialog.
2	Select <b>Monitors and sensors</b> from the <b>Component types</b> list.
3	Select <b>I/O-box (E9)</b> or <b>I/O-box 2 (E9)</b> in the <b>Component selection</b> list.

### System settings

Default values for digital out ports, noise reduction and configuration of analog out ports can be set.

Instruction name	Description
<b>Digital out X</b>	Sets the value of the signal sent out by digital port number X to either 0 or 1. The default value is 1.
<b>Noise reduction analog in X</b>	Filters the noise in the analog signal in port number X.
<b>Alarm analog in X</b>	Enables or disables the alarm for the analog signal in port number X. When enabled, it sets the alarm limits for the analog signal. If the alarm is enabled and the analog signal falls outside the set limits, an alarm will be triggered and the method will be paused.
<b>Alarm digital in X</b>	Enables or disables the alarm for the signal in digital port number X. The alarm can be triggered by either of the signal values, 0 or 1. If the alarm is enabled and the condition set in 'Value' occurs, an alarm will be triggered and the method will be paused.
<b>Configure analog out X</b>	Enables the user to send one of the pre-defined signals (UV signal, conductivity, temperature, pH or concentration of eluent B) to the analog out port number X, and also to set the range of that signal.

**Note:** The delay volume has to be updated if an external component is added to the flow path.



## 4.3 General system settings

### Check/Set delay volume

When a module has been installed after the UV monitor in the flow path, the delay volume has to be adjusted in the **System Setting** dialog in UNICORN, to make sure that the collected fractions correspond to the fractions indicated in the chromatogram.

Delay volumes can be set for the options **Monitor to outlet valve**, **Monitor to frac**, **Monitor to frac 2**, and **pH valve**. Depending on the system configuration used, different delay volume options will be available for selection in the **System Setting** dialog. The delay volume has to be set for all displayed options.

Delay volumes for modules and standard tubing configurations are found in [Section 9.13 Delay volumes, on page 493](#).

Follow the instructions below to check/set the delay volumes:

- | Step | Action  |
|------|---|
| 1    | <ul style="list-style-type: none"> <li>In the <b>System Control</b> module, choose <b>System:Connect to Systems</b> or click the <b>Connect to Systems</b> icon.</li> </ul> <p><i>Result:</i> The <b>Connect to Systems</b> dialog opens.</p> |
| 2    | <ul style="list-style-type: none"> <li>Select a system.</li> <li>Select <b>Control</b> mode.</li> <li>Click <b>OK</b>.</li> </ul> <p><i>Result:</i> The selected instrument can now be controlled by the software.</p>                        |
| 3    | <ul style="list-style-type: none"> <li>When the system is in state <b>Ready</b>, select <b>System:Settings</b>.</li> </ul> <p><i>Result:</i> The <b>System Settings</b> dialog is displayed.</p>  |

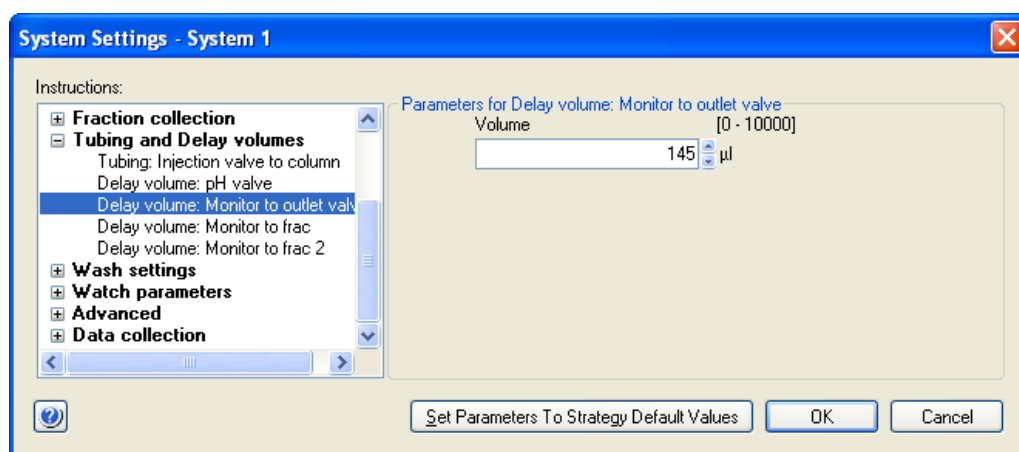

- |   |   |
|---|---|
| 4 | <ul style="list-style-type: none"> <li>Select <b>Tubing and Delay Volumes</b> and select the delay volume option of interest.</li> <li>Check the delay volume in the <b>Volume</b> field and enter a new value if necessary.</li> <li>Click <b>OK</b>.</li> </ul> |
|---|---|

## Lock/Unlock function

Follow the instruction below to lock or unlock the **Pause** and **Continue** buttons of the Instrument control panel from UNICORN.

- | Step | Action   |
|------|--|
| 1    | In <b>System Control</b> , select <b>System:Settings</b> .<br><i>Result:</i> The <b>System Settings</b> dialog opens.  |
| 2    | In the <b>System Settings</b> dialog: <ul style="list-style-type: none"><li>• Select <b>Advanced:Instrument control panel</b>.</li><li>• Select <b>Locked</b> or <b>Unlocked</b>.</li><li>• Click <b>OK</b>.</li></ul> |

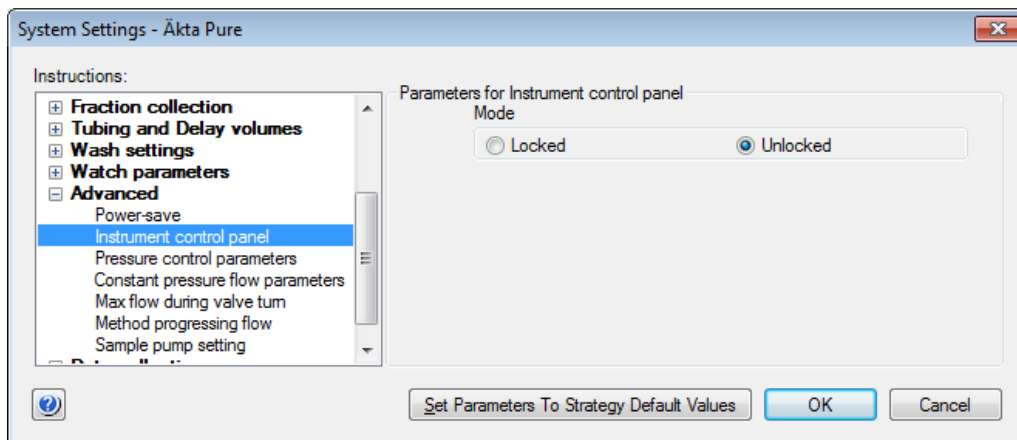

## Power-save

ÄKTA pure has a power-save mode. The instrument enters **Power-save** after having been in the **Ready** state for a set period of time. **Power-save** can be used both in room temperature and in cold room temperature. The system enters the **Ready** state when a method run, a method queue or a manual run ends.

To enable **Power-save**, a system must be connected and in state **Ready**.

Follow the instructions below to activate **Power-save**.

Step	Action
------	--------

1	Select <b>System:Settings</b> in the <b>System Control</b> module.
---	--

*Result:* The **System Settings** dialog opens.

- |   |   |
|---|---|
| 2 | <ul style="list-style-type: none"><li>• Select <b>Advanced</b></li><li>and</li><li>• select <b>Power-save</b></li></ul> |
|---|---|

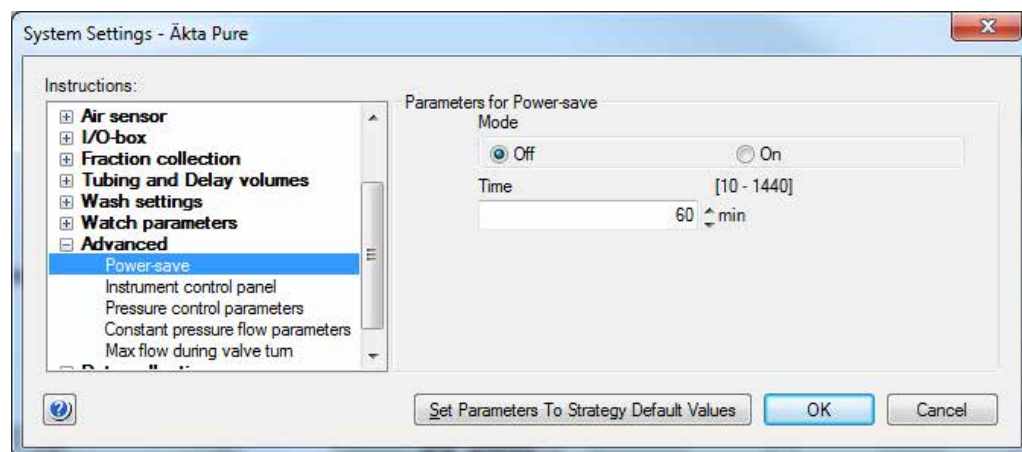

- |   |  |
|---|--|
| 3 | <ul style="list-style-type: none"><li>• Select <b>On</b> in the <b>Mode</b> field</li><li>and</li><li>• type the number of minutes in the <b>Time</b> field.</li></ul> |
|---|--|

**Note:**

*This is the time the instrument will be in state **Ready** before power-save mode is entered.*

- |  |  |
|--|--|
|  | <ul style="list-style-type: none"><li>• Click <b>OK</b>.</li></ul> |
|--|--|

# 5 Operation

## About this chapter

This chapter describes the steps involved when operating ÄKTA pure.

---

## In this chapter

This chapter contains the following sections:

Section	See page
5.1 Before you prepare the system	149
5.2 Prepare the flow path	150
5.3 Start UNICORN and connect to system	157
5.4 Prime inlets and purge pump heads	160
5.5 Connect a column	172
5.6 Pressure alarms	176
5.7 Sample application	179
5.8 Fractionation	192
5.9 Create a method and perform a run	210

---

## 5.1 Before you prepare the system

### Introduction

It is important to prepare the system in accordance with the settings in the method to be run. Before preparing the system, check the settings in the **Method Editor** and make sure that all accessories to be used are available.

---

### Checklist

Make sure the system is prepared in accordance with the settings in the method to be run. Depending on configuration, remember to check:

- which valve ports to use for inlets and outlets
  - which column type to use
  - which column position to use
  - which buffers and samples to prepare
  - which sample application technique to use
  - that the pH electrode is connected and calibrated
-

## 5.2 Prepare the flow path

### Introduction

The flow path is defined by the user and may contain tubing, valves, pumps and monitors. This section gives an overview of a flow path and describes how to prepare the flow path before a run.

### Illustration of the flow path

The illustration below shows the flow path for a typical system configuration. The individual instrument modules are presented in the table below. The configuration of the system is defined by the user.

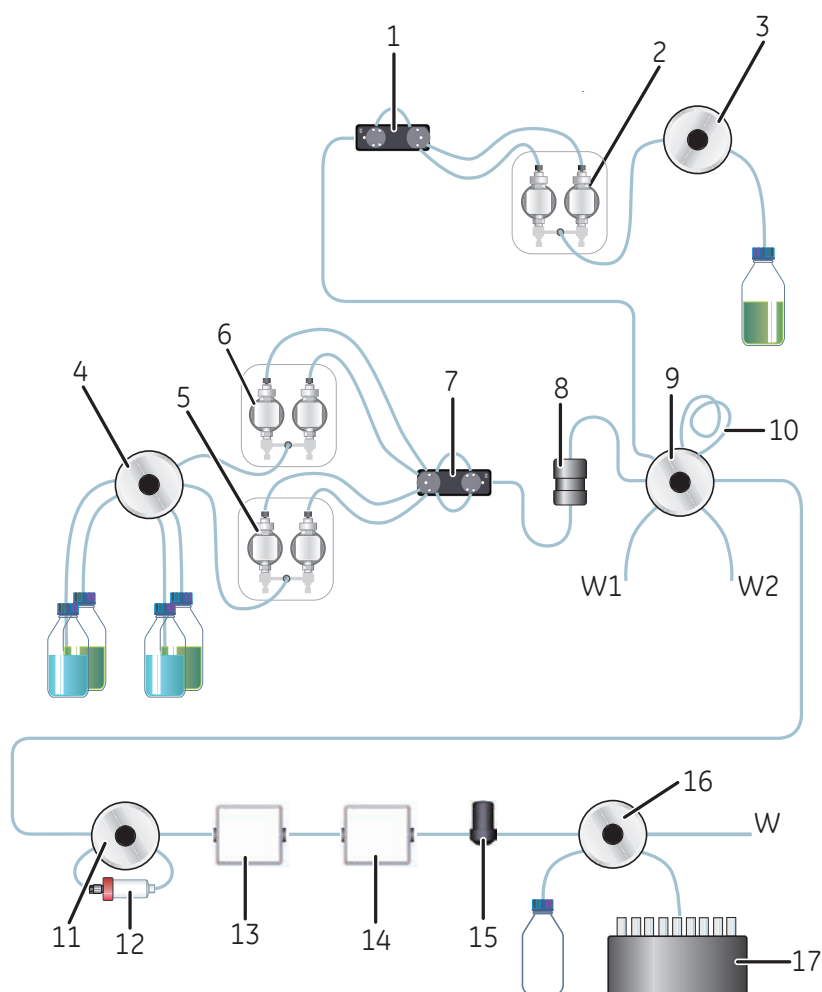

Part	Description
1	Pressure monitor
2	Sample pump
3	Sample inlet valve

Part	Description
4	Inlet valve
5	System pump B
6	System pump A
7	Pressure monitor
8	Mixer
9	Injection valve
10	Sample loop or Superloop
11	Column valve
12	Column
13	UV monitor
14	Conductivity monitor
15	Flow restrictor
16	Outlet valve
17	Fraction collector
W, W1, W2	Waste

## Select Mixer chamber

To obtain a homogeneous buffer composition, it is important to use a Mixer chamber suitable for the flow rate of the method. The tables below show what Mixer chambers to use in ÄKTA pure at different flow rates.

If the liquids are difficult to mix, use a larger Mixer chamber to achieve optimal mixing. However, note that a larger Mixer chamber distorts and delays the gradient.

The default mixer size is 1.4 ml for both systems. ÄKTA pure 150 also includes a 5 ml mixer. Other mixer sizes are available as accessories.

Mixer chamber volume [ml]	Flow rate [ml/min], Binary gradient	
	ÄKTA pure 25	ÄKTA pure 150
0.6	0.1-5	<i>Not recommended</i>
1.4	0.5-15	0.5-15
5	2-25	2-50
15	<i>Not compatible</i>	15-150

**CAUTION**

**Risk of explosion.** Do not use Mixer chamber 15 ml with an ÄKTA pure 25 configuration. The maximum pressure for Mixer chamber 15 ml is 5 MPa.

**Note:** In ÄKTA pure 25 at low flow rates (below 0.2 ml/min) a gradient of sufficient quality may be achieved with the mixer bypassed. Similarly, for low flow rates in ÄKTA pure 150 the 0.6 ml mixer might be used.

**Note:** The 1.4 ml mixer in ÄKTA pure 25 or 5 ml mixer in ÄKTA pure 150 might work up to maximum flow rate provided that the buffers are easily mixed.

For information on how to install a Mixer chamber, refer to [Section 7.8.3 Replace the Mixer, on page 322](#).

## Select UV flow cells

### General considerations

Flow cells with shorter path lengths are suitable to use when high protein concentrations are used. Flow cells with longer path lengths are suitable to use when low protein concentrations are used.

### UV flow cells for UV monitor U9-M

UV flow cells are available with three different path lengths; 0.5 mm, 2 mm (default) and 10 mm.

The real cell path length of the UV cell is automatically recognized by the monitor when a cell is fitted. The UV data is normalized to the nominal path length. This allows UV data from runs made with different UV flow cells (but with the same nominal path length) to be directly compared.

### UV flow cells for UV monitor U9-L

UV flow cells are available with two different path lengths; 2 mm (default) and 5 mm. When replacing a UV flow cell, the path length must be set in the **System Control** module, in **System:Calibrate**. Use the nominal flow cell length if the UV flow cell is replaced but not calibrated. See [Update the cell path length, on page 314](#) to set the flow cell path length.

The path length of the UV flow cell might differ from the nominal length, which leads to incorrect results in the calculation of protein concentration in the eluate. The UV data is normalized to the nominal path length. This allows UV data from runs made with different UV flow cells (but with the same nominal path length) to be directly compared. To achieve normalized absorbance, the path length of the UV flow cell must be calibrated and the calculated flow cell path length set manually. See [Calibration of the UV monitor U9-L flow cell length, on page 312](#).

## Prepare the inlet tubing

Connect inlet tubing to the inlet ports that are to be used, and place all inlet tubing that is to be used during the method run in the correct buffers.

**Note:** When using high viscosity buffers/samples in combination with high flow rates it is recommended to increase the tubing I.D. and/or shorten the length.



## Prepare the outlet tubing

Connect outlet tubing to the outlet ports of Outlet valve that are to be used. If a fraction collector is to be used, make sure that tubing is connected as described in [Connect tubing, on page 102](#) and [Connect tubing to ÄKTA pure, on page 106](#), and prepare the fraction collector. Otherwise, place the outlet tubing in suitable tubes or flasks.

---

## Waste tubing overview

The table below lists the waste tubing of the instrument and where it is located. Make sure that the waste tubing is connected to the correct positions on the modules.

Module	Tubing connections	Location of tubing
Injection valve	Waste ports <b>W1</b> and <b>W2</b>	Front of the ÄKTA pure instrument.
pH valve (optional)	Waste port <b>W3</b>	Front of the ÄKTA pure instrument.
Outlet valve (optional)	Waste port <b>W</b>	Front of the ÄKTA pure instrument.
Buffer tray (Rescue drainage)	Drainage hole of the Buffer tray	Rear of the ÄKTA pure instrument.
Fraction collector F9-C (optional)	Fraction collector waste outlet	Rear of the fraction collector.

## Prepare waste tubing

Follow the instructions below to prepare the waste tubing.



### CAUTION

**Fasten the waste tubing.** During operation at high pressure the ÄKTA pure instrument may release bursts of liquid in the waste tubing. Securely fasten all waste tubing to the ÄKTA pure instrument and to the waste vessel.



### CAUTION

Make sure that the waste vessel will hold all the produced volume of the run. For ÄKTA pure, a suitable waste vessel should typically have a volume of 2 to 10 liters.



### NOTICE

The maximum level of the waste vessel must be lower than the bottom of the ÄKTA pure instrument.

- | Step | Action   |
|------|--|
| 1    | Insert the waste tubing from all installed modules, in this example Injection valve, Outlet valve ( <b>W</b> , <b>W1</b> and <b>W2</b> ) and the fraction collector, in a vessel.                            |
| 2    | Make sure that the tubing is securely fastened to the ÄKTA pure instrument: <ul style="list-style-type: none"><li>• Fasten waste tubing from the valves with the clips on the front of the system.</li></ul> |

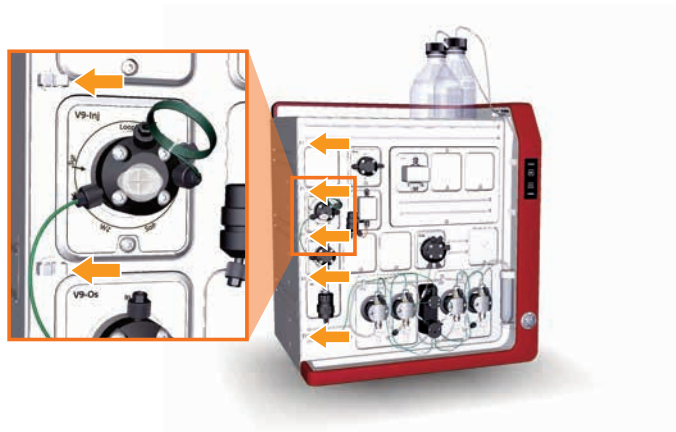

- Fasten waste tubing from the Buffer tray with the clips on the rear of the system.



Step	Action
3	Cut the waste tubing to appropriate length. It is important that the tubing is not bent and will not be submerged in liquid during the run.



**Note:**

*If the tubing is too short, replace it with new tubing. Do not lengthen the tubing as this might cause obstruction of the tubing.*

4	Fasten all waste tubing securely to the waste vessel.
---	---

## Plug unused valve ports

It is recommended to plug all unused valve ports with stop plugs before starting a run. See [Tubing connectors, on page 421](#) for information about connectors.

## 5.3 Start UNICORN and connect to system

### Introduction

This section describes how to start and log on to UNICORN and how to connect the instrument to UNICORN.

---

### Start UNICORN and log on

Follow the instructions to start UNICORN and log on to the program. A valid e-license must be available for the workstation. See UNICORN Administration and Technical Manual for more information about e-licenses.

Step	Action
------	--------

1	Double-click the UNICORN icon on the desktop.
---	---

*Result:* The **Log On** dialog box opens.

**Note:**

*If there is no connection to the database it is still possible to log on to UNICORN and control a running system. The **Log On** dialog box will give the option to start **System Control** without a database. Click **Start System Control** to proceed to the next **Log On** dialog box.*

2	In the <b>Log On</b> dialog box:
---	----------------------------------

- Click a user name in the **User Name** list and
- enter the password in the **Password** field.

**Note:**

*It is also possible to select the **Use Windows Authentication** check box and enter a network ID in the **User Name** box.*

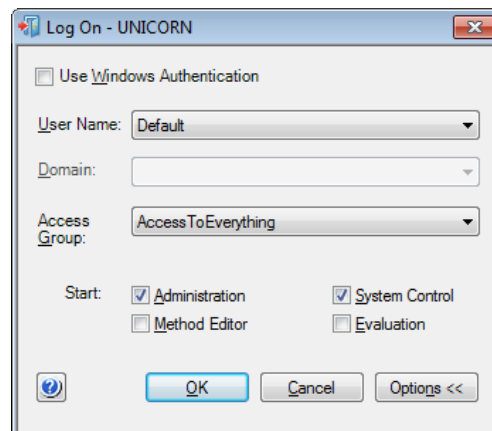

- select which UNICORN modules to start.
- click **OK**.

*Result:* The selected UNICORN modules open.

---

## Connect to system

Follow the instructions to connect the instrument to UNICORN.

Step	Action
------	--------

- |   |  |
|---|--|
| 1 | In the <b>System Control</b> module, <ul style="list-style-type: none"><li>Click the <b>Connect to Systems</b> button,</li></ul> |
|---|--|



or

- click **Connect to Systems** on the **System** menu.

*Result:* The **Connect to Systems** dialog opens.

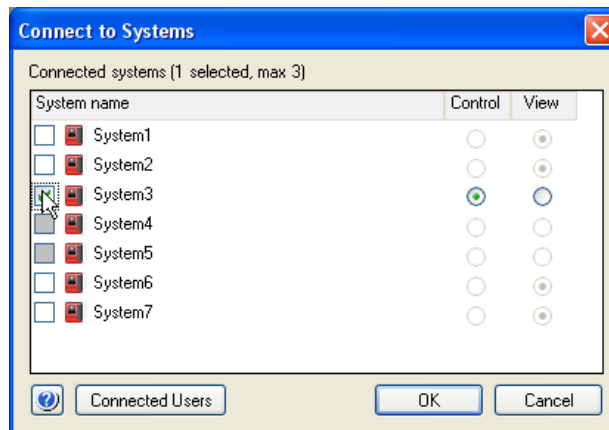

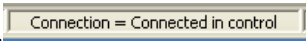
Step	Action
2	<p>In the <b>Connect to systems</b> dialog:</p> <ul style="list-style-type: none"><li>• Select the checkbox in front of the system name.</li><li>• To control the selected system, click <b>Control</b>.</li><li>• Click <b>OK</b>.</li></ul> <p><i>Result:</i> The instrument control panel displays a white, rapidly flashing light followed by a steady white light when the system is ready. The selected instrument can now be controlled by the software.</p> <p><b>Note:</b> <i>Instruments that are turned off or disconnected from the network appear dimmed and cannot be connected.</i></p> <p><b>Tip:</b> <i>To view the users currently connected to systems, either in control or view mode, click the <b>Connected Users</b> button.</i></p> <p><b>Tip:</b> <i>Result: UNICORN states <b>Connection = Connected in control</b> or <b>Connection = Connected in view</b> in the status bar in the lower part of the <b>System Control</b> window.</i></p>  <p>The screenshot shows a small rectangular status bar with a thin border. Inside the bar, the text "Connection = Connected in control" is displayed in a standard sans-serif font.</p>

## 5.4 Prime inlets and purge pump heads

### About this section

Before usage of a pump, it is important to:

- Prime the inlets (fill the buffer inlets with liquid).
- Purge the pump (remove air from the pump heads).

This section describes how to prime inlets and purge the pump heads of the system pumps and the sample pump (the sample pump is an optional module).

**Note:** *Note that the procedures described in this section may have to be adapted if your system configuration differs from the one described in this manual.*

---

### In this section

This section contains the following subsections:

Section	See page
5.4.1 System pumps	161
5.4.2 Sample pump	167

---



## 5.4.1 System pumps

### Introduction

This section describes how to prime inlets and purge the System pumps.

---

### Overview

The procedure consists of the following stages:

Stage	Description
1	Prime all inlet tubing to be used during the run
2	Purge System pump B
3	Validate purge of System pump B
4	Purge System pump A
5	Validate purge of System pump A
6	End the run

---

**Tip:** *The procedures for purging the pump heads and priming the inlets using the **Process Picture**, are described below. It is also possible to perform the procedures from the **Manual instructions** dialog.*

---

### Prime inlet tubing

Follow the instructions below to fill all A and B inlet tubing to be used in the run with appropriate buffer/solution.

Step	Action
1	Make sure that all inlet tubing that is to be used during the method run is placed in the correct buffer.
2	Open the <b>System Control</b> module.

## 5 Operation

### 5.4 Prime inlets and purge pump heads

#### 5.4.1 System pumps

Step	Action
3	<p>In the <b>Process Picture</b>:</p> <ul style="list-style-type: none"><li>Click on the buffer inlets.</li><li>Select the position of the inlet to be filled. Select the positions in reverse alphabetical order and start with the highest number. For example, if all the four inlets in Inlet valve AB are to be filled, fill them in the following order: B2, B1, A2, A1.</li></ul>

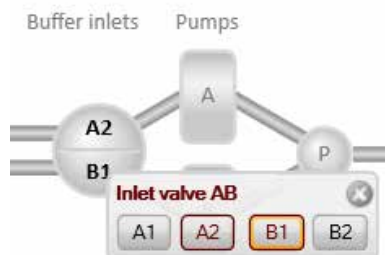

*Result:* The inlet valve switches to the selected port.

4	Connect a 25 to 30 ml syringe to the purge valve of one of the pump heads of the pump that is being prepared. Make sure that the syringe fits tightly into the purge connector.
---	---

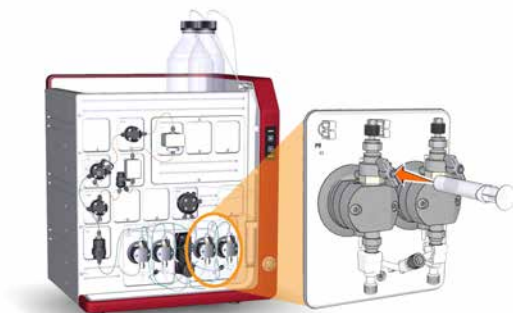

5	Open the purge valve by turning it counter-clockwise about three quarters of a turn. Draw liquid slowly into the syringe until the liquid reaches the pump.
6	Close the purge valve by turning it clockwise. Disconnect the syringe and discard its contents.
7	Repeat steps 3 to 6 for each piece of inlet tubing that is to be used during the run.

## Purge System pump B

Follow the instruction below to purge both pump heads of System pump B.

Step	Action
1	Make sure that the piece of waste tubing connected to the Injection valve port <b>W1</b> is placed in a waste vessel.

**Step**      **Action**

2      In the **Process Picture**:

- Click on the **Injection valve** and select **System pump waste**.

*Result:* The Injection valve switches to waste position. This is necessary to achieve a low back pressure during the purge procedure.

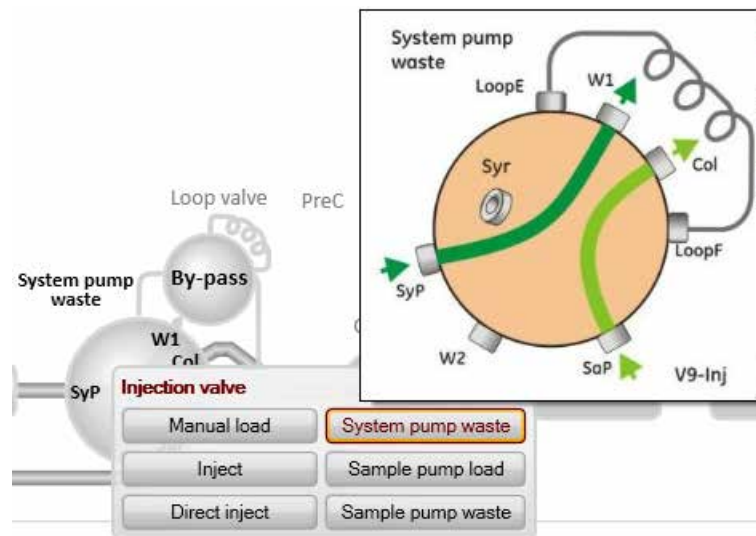

3      In the **Process Picture**:

- Click on the pumps.
- Set **Conc % B** to 100% B.

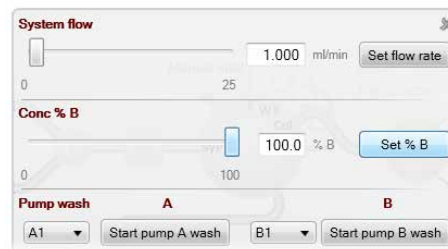

- Click **Set % B**.

*Result:* Only System pump B is active.

## 5 Operation

### 5.4 Prime inlets and purge pump heads

#### 5.4.1 System pumps

- | Step | Action  |
|------|---|
| 4    | In the <b>Process Picture</b> : <ul style="list-style-type: none"><li>Click on the buffer inlets.</li><li>Select the position of one of the inlets that will be used at the beginning of the run.</li></ul> |

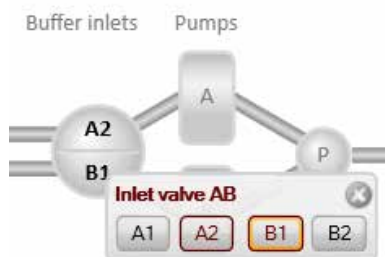

*Result:* The inlet valve switches to the selected port.

- |   |  |
|---|--|
| 5 | In the <b>Process Picture</b> : <ul style="list-style-type: none"><li>Click on the <b>Pumps</b>.</li><li>Set the <b>System flow</b> to 1.0 ml/min for ÄKTA pure 25 or 10.0 ml/min for ÄKTA pure 150.</li><li>Click <b>Set flow rate</b>.</li></ul> |
|---|--|

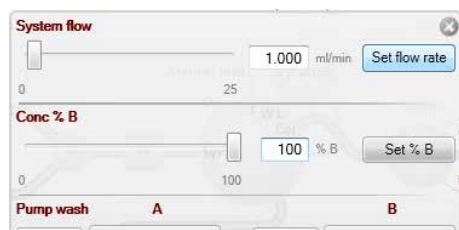

*Result:* A system flow starts.

- |   |  |
|---|--|
| 6 | Connect a 25 to 30 ml syringe to the purge valve of the left pump head of System pump B. Make sure that the syringe fits tightly into the purge connector. |
|---|--|

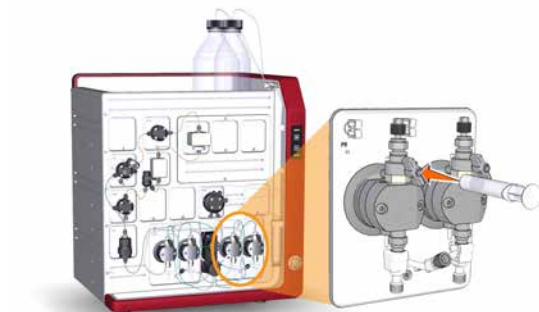

- |   |  |
|---|--|
| 7 | Open the purge valve by turning it counter-clockwise about three quarters of a turn. Draw a small volume of liquid slowly into the syringe (with a rate of about 1 ml per second). |
| 8 | Close the purge valve by turning it clockwise. Disconnect the syringe and discard its contents.  |

Step	Action
9	Connect the syringe to the purge valve on the right pump head of System pump B, and repeat steps 6 to 8. Keep the system flow running.

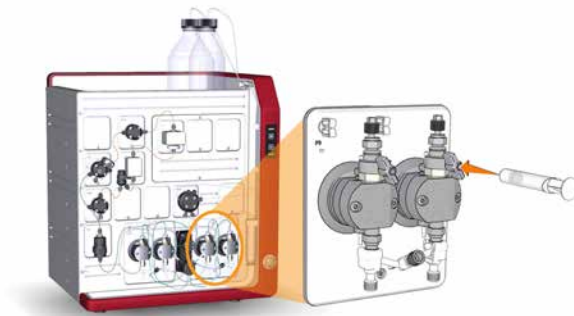

## Validate purge of pump B

Follow the instructions below to check that there is no air left in the pump after performing a purge.

Step	Action
1	In the <b>Process Picture</b> : <ul style="list-style-type: none"> <li>Click on the <b>Injection valve</b> and select <b>Manual load</b>.  <i>Result:</i> The Injection valve switches to manual load position.</li> </ul>

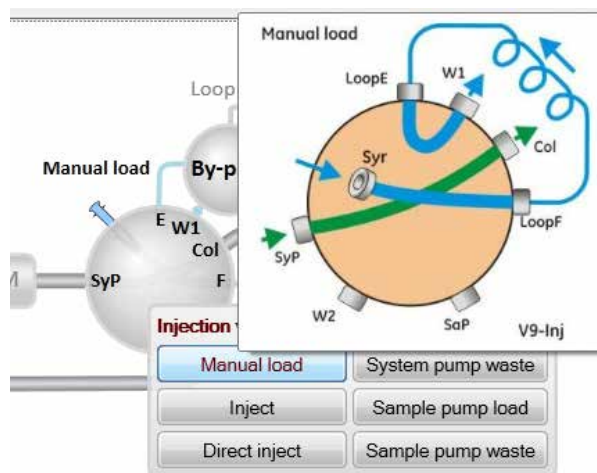

2	Make sure that the pump flow is on.
3	In the <b>Chromatogram</b> pane: Check the <b>PreC pressure</b> curve.  If the PreC pressure do not stabilize within a few minutes there may be air left in the pump. Refer to <a href="#">Section 8.6 Troubleshooting: Pumps, on page 387</a> .

## 5 Operation

### 5.4 Prime inlets and purge pump heads

#### 5.4.1 System pumps

## Purge System pump A

Purge both pump heads of System pump A by following the same procedure as in [Purge System pump B, on page 162](#), but replace step 3 with the following actions:

In the **Process Picture**:

- Click on the pumps.
- Set **Conc % B** to 0% B.

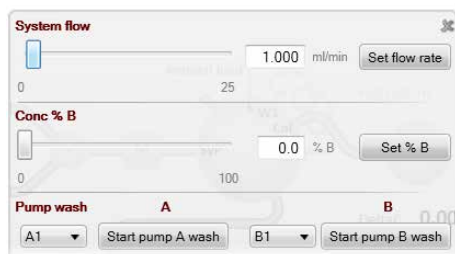

- Click **Set % B**

*Result:* Only System pump A is active.

---

## Validate purge of pump A

Follow the procedure described in [Validate purge of pump B, on page 165](#) to check if there is air left in the pump.

---

## End the run

Click the **End** button in the **System Control** toolbar to end the run.



## 5.4.2 Sample pump

### Introduction

This section describes how to prime inlets and purge Sample pumps **S9** and **S9H**.

---

### Overview

The procedure consists of the following steps:

- 1 Prime all sample inlet tubing to be used during the run
  - 2 Purge the Sample pump
  - 3 Validate purge
  - 4 End the run
- 

### Prime sample inlets

Follow the instructions below to fill all sample inlet tubing, to be used in the run, with appropriate buffer or solution. Skip steps three and four if no sample inlet valve is used.

Step	Action
1	Make sure that all sample inlet tubing that is to be used during the method run is immersed in the correct buffers.
2	Make sure that the waste tubing connected to Injection valve port W2 is immersed in a waste vessel.
3	Open the <b>System Control</b> module.

## 5 Operation

### 5.4 Prime inlets and purge pump heads

#### 5.4.2 Sample pump

- | Step | Action  |
|------|---|
| 4    | <p>In the <b>Process Picture</b> :</p> <ul style="list-style-type: none"><li>Click on <b>Sample inlet valve</b>.</li><li>Select the position of the inlet to be filled. Start at the inlet position with the highest number and end at the position with the lowest number.</li></ul> |

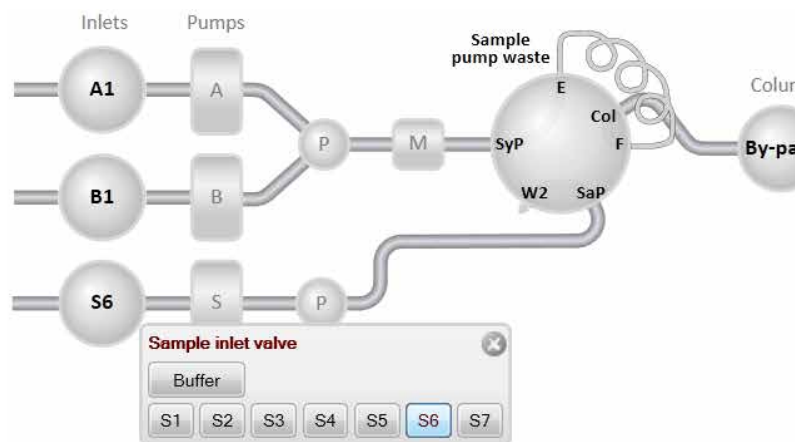

*Result:* the sample inlet valve switches to the selected port.

- 5 Connect a 25 to 30 ml syringe to one of the purge valves of the pump heads of the Sample pump. Make sure that the syringe fits tightly into the purge connector.



- 6 Open the purge valve by turning it counter-clockwise about three-quarters of a turn. Draw liquid slowly into the syringe until the liquid reaches the sample pump.
- 7 Close the purge valve by turning it clockwise. Disconnect the syringe and discard its contents.
- 8 Repeat steps 2-5 for each sample inlet that is to be used in the method run.



## Purge the Sample pump

Follow the instruction below to purge both the pump heads of the Sample pump.

- | Step | Action  |
|------|---|
| 1    | Make sure that all sample inlet tubing that is to be used during the method run is immersed in the correct buffers.                                     |
| 2    | Make sure that the waste tubing connected to Injection valve port <b>W2</b> is immersed in a waste vessel.  |
| 3    | Open the <b>System Control</b> module.  |
| 4    | In the <b>Process Picture</b> : <ul style="list-style-type: none"> <li>Click on <b>Injection valve</b> and select <b>Sample pump waste</b> .</li> </ul> |

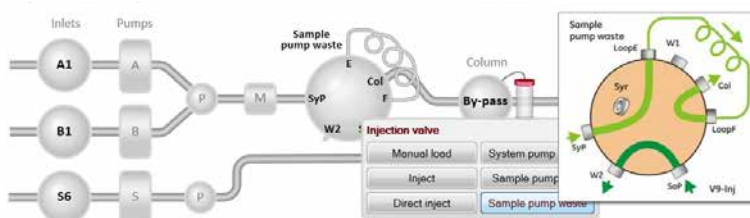

*Result:* The injection valve switches to waste position. This is necessary to achieve a low back pressure during the purge procedure.

- 5 In the **Process Picture**: Click on **Sample pump**.
- If Sample inlet valve **V9-IS** or **V9H-IS** is used: Click on the **Sample inlet valve** icon (if the valve is not used, the icon will not be present):  
 Select the **Buffer** inlet.
  - Click on the **Sample pump** icon: Set the **Sample flow** to 1.0 ml/min for ÄKTA pure 25 or 10.0 ml/min for ÄKTA pure 150.

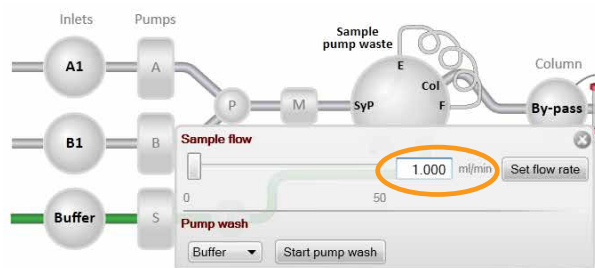

- Click **Set flow rate** and close the pop-up window.  
*Result:* a sample pump flow starts.

## 5 Operation

### 5.4 Prime inlets and purge pump heads

#### 5.4.2 Sample pump

Step	Action
6	Connect a 25 to 30 ml syringe to the left purge valve of the Sample pump. Make sure that the syringe fits tightly into the purge connector.



- 7 Open the purge valve by turning it counter-clockwise about three-quarters of a turn. Draw 5-10 ml of liquid slowly into the syringe with a rate of about 1 ml/s.
- 8 Close the purge valve by turning it clockwise. Disconnect the syringe and discard its contents.
- 9 Connect the syringe to the right purge valve on the Sample pump, and repeat step 6 to step 8.



## Validate purge

Follow the instructions below to check that there is no air left in the pump after performing a purge.

Step	Action
------	--------

- |   |   |
|---|---|
| 1 | In the <b>Process Picture</b> : <ul style="list-style-type: none"><li>Click on the <b>Injection valve</b> and select <b>Direct inject</b>.<br/><i>Result:</i> The Injection valve switches to direct inject position.</li></ul> |
|---|---|

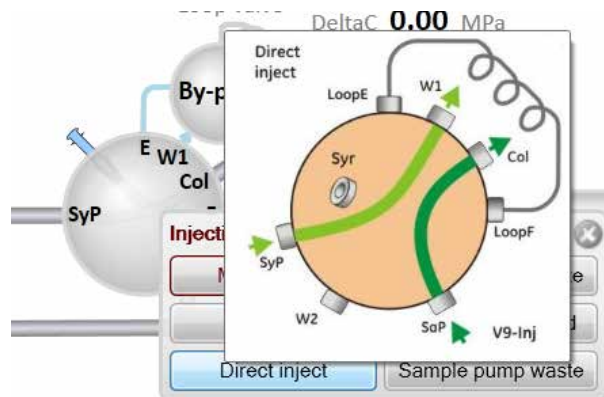

- |   |   |
|---|---|
| 2 | Make sure that the pump flow is on.   |
| 3 | In the <b>Chromatogram</b> pane:<br>Check the <b>PreC pressure</b> curve.<br>If the PreC pressure does not stabilize within a few minutes there may be air left in the pump. Refer to <a href="#">Section 8.6 Troubleshooting: Pumps, on page 387</a> . |

## End the run

Click the **End** button in the **System Control** toolbar to end the run.



## 5.5 Connect a column

### Introduction

This section describes how to connect a column to the instrument using a column holder and without introducing air into the flow path. Several types of column holders are available for ÄKTA pure.



#### WARNING

To avoid exposing the column to excessive pressure, make sure that the pressure limit is set to the specified maximum pressure of the column. Before connecting a column to the ÄKTA pure instrument, read the instructions for use of the column.

Methods automatically include a pressure alarm based on the specifications of the chosen column type. However, when running manual runs you have to set the pressure limits yourself. Also, to protect the column media, special settings are needed. See [Section 5.6 Pressure alarms, on page 176](#) for more information on pressure alarms.

**Note:** Do not overtighten when connecting columns. Overtightening might rupture the connectors or squeeze the tubing and thereby result in high back pressure.

**Note:** If no column valve is used, remove the column from the system before running a system wash. The pressure during a system wash may become too high for the column.

### Attach a column holder and connect a column

Follow the instructions below to connect a column to the instrument. Always use a column holder. If a column valve is used, connect the column to the appropriate A and B ports on the valve. If no column valve is used, connect the column directly to the flow path tubing. Use appropriate tubing and connectors. The instructions below show a system configured with Column valve **V9-Cs**.

Step	Action
------	--------

- |   |  |
|---|--|
| 1 | Attach an appropriate column holder to the rail on the instrument. |
|---|--|

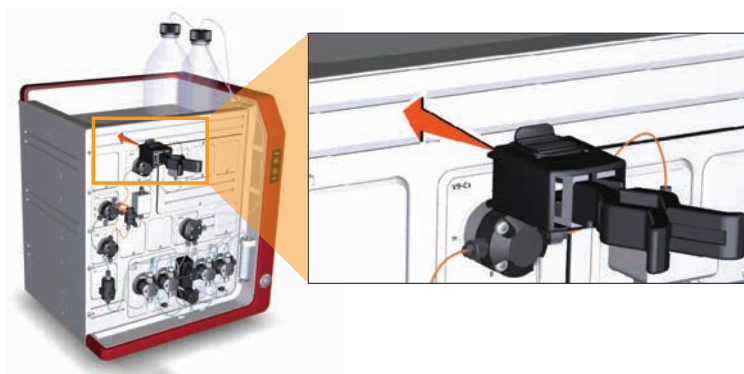

Step	Action
2	Attach the column to the column holder.



- 3 Connect a suitable tubing to a Column valve port, in this example port **1A**.
- 4 Open the **System Control** module.
- 5 In the **Process Picture**:
  - Click on the **Column**.
  - Select **Column down flow**.

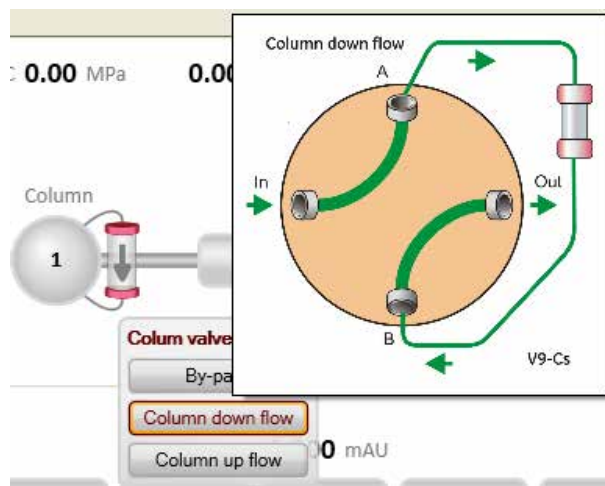

*Result:* The Column valve switches to position **1**.

Step	Action
------	--------

- |   |   |
|---|---|
| 6 | In the <b>Process Picture</b> : <ul style="list-style-type: none"><li>• Click on the <b>Pumps</b>.</li><li>• Enter a low <b>System flow</b> (e.g., 0.2 ml/min).</li><li>• Click <b>Set flow rate</b>.</li></ul> |
|---|---|

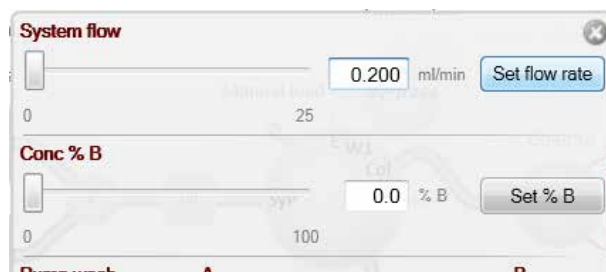

*Result:* A system flow of 0.2 ml/min starts.

- |   |   |
|---|---|
| 7 | When buffer leaves the tubing in a continuous mode and the top part of the column is filled with buffer, connect the tubing to the top of the column. |
|---|---|



- |   |  |
|---|--|
| 8 | Connect a piece of tubing to the bottom of the column. |
|---|--|



Step	Action
9	When buffer leaves the tubing at the bottom of the column in a continuous mode, connect this piece of tubing to the Column valve. Use the port opposite to the one already connected to the column, in this example port <b>1B</b> . If no column valve is used, connect the tubing to the next module in the flow path.



10	Click the <b>End</b> icon in the <b>System Control</b> toolbar to end the run.
----	--



## 5.6 Pressure alarms

### Introduction

The columns can be protected by two different types of pressure alarms:

- The pre-column pressure alarm protects the column hardware
- The delta-column pressure alarm (only available when **V9-C** or **V9H-C** is installed) protects the column media

Column valves **V9-C** and **V9H-C** have built-in pressure sensors that automatically measure the pre-column and delta-column pressure. If Column valve **V9-C** or **V9H-C** is not used (column is connected without a Column valve or to Column valve **V9-Cs** or **V9H-Cs**), the pre-column pressure is calculated from the system pressure and tubing dimensions.

See the instructions below to set the pressure alarm for the column to be used in the run and, if applicable, to set the parameters for the tubing dimensions.

### Set tubing dimension parameters to calculate pre-column pressure

For instruments where there is no pre-column pressure sensor, i.e. the column is connected without a Column valve or to Column valve **V9-Cs** or **V9H-Cs**, the pre-column pressure is calculated from the system pressure and tubing dimensions. Follow the instructions below to set the tubing dimension parameters.

- | Step | Action   |
|------|--|
| 1    | Select <b>System:Settings</b> in the <b>System Control</b> module.<br><i>Result:</i> The <b>System Settings</b> dialog opens.                                  |
| 2    | <ul style="list-style-type: none"><li>• Select <b>Tubing and Delay Volumes</b></li><li>and</li><li>• select <b>Tubing: Injection valve to column</b></li></ul> |

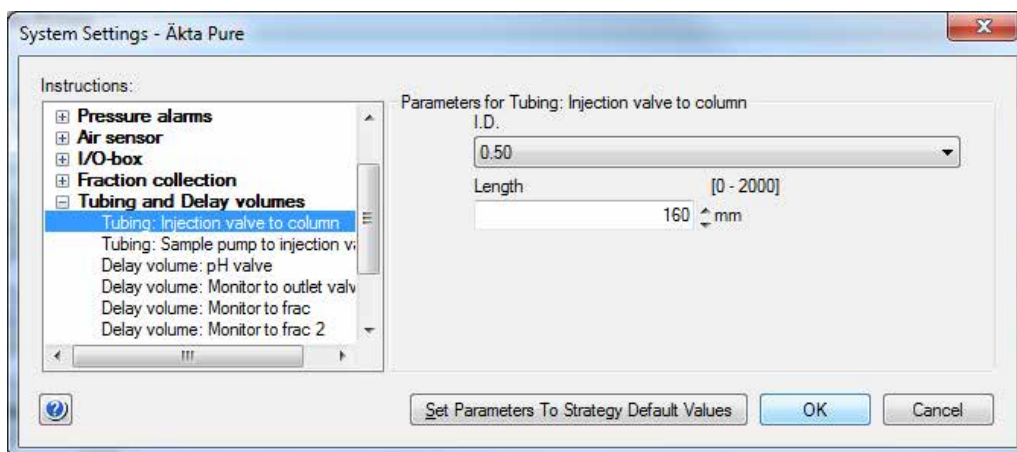



Step	Action
3	<ul style="list-style-type: none"><li>• Select the inner diameter of the tubing between the injection valve and the column from the <b>I.D.</b> drop-down list.</li><li>• Type in the tubing <b>Length</b>.</li></ul>
4	If the sample pump is used: <ul style="list-style-type: none"><li>• Select <b>Tubing: Sample pump to injection</b>.</li><li>• Set tubing i.d. and length, see step 3.</li></ul>
5	Click <b>OK</b> .  <b>Note:</b> <i>The system now calculates the Pre-column pressure.</i>

## Pre-column pressure alarms

It is important that the pre-column pressure alarm is set during all runs where a column is used. The pressure alarm can be set in:

- the method to be run,
- the **System Settings** dialog , or
- during a manual run

Pre-column pressure alarm limits are automatically set in the method when a column from the column list is selected in the method. Refer to UNICORN Method Manual for more information on pressure alarms.

For some columns the max delta-column pressure (media) is significantly lower than the max pre-column pressure (hardware). To protect the media if a delta-column pressure measurement is not available (that is, when column valve **V9-C** or **V9H-C** is not used), the pre-column pressure alarm must be manually set to the value in the column list that is the lowest of the max pre-column pressure and the max delta-column pressure.

## Delta-column pressure alarms

If column valve **V9-C** or **V9H-C** is installed the delta-column pressure will be measured, but the alarm must be set manually if needed.

## Set pressure alarms

Pressure alarm limits may be set manually in **System Control**. The example below describes how to set the high pressure limit for the column. Other alarms are set in a corresponding way.

Step	Action
1	Select <b>Manual:Execute Manual Instructions...</b> in the <b>System Control</b> module. <i>Result:</i> The <b>Manual instructions</b> dialog opens.

**Step**      **Action**

---

- 2
- Select **Alarms**  
and
  - select **Alarm pre column pressure**.

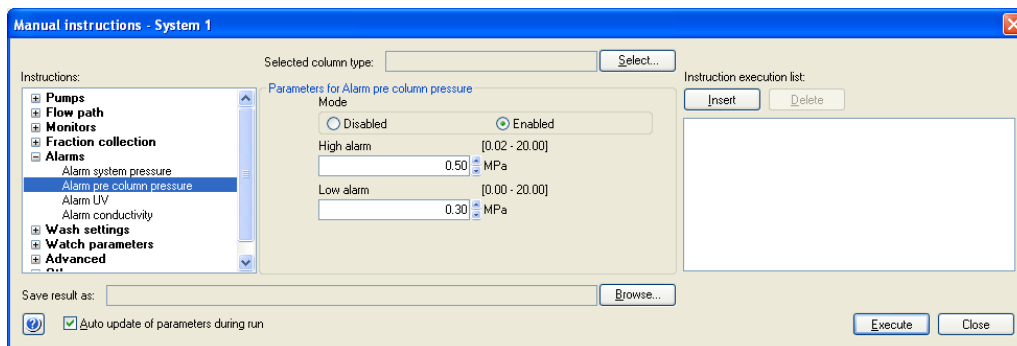

- 3      Select **Enabled** in the **Mode** field.
- 4
- Type the high pressure limit in the **High alarm** field.
  - Click **Execute**.
-

## 5.7 Sample application

### Introduction

This section describes the different sample application techniques that can be used with ÄKTA pure. The table below shows the alternatives for sample application available in the **Sample application** phase of a method.

Sample application	Via	Compatible loops
Inject sample directly onto column	<ul style="list-style-type: none"> <li>Sample pump</li> <li>System pump A</li> <li>System pump A and Air sensor</li> </ul>	<ul style="list-style-type: none"> <li>Not applicable</li> </ul>
Inject sample from loop	<ul style="list-style-type: none"> <li>Syringe</li> <li>Sample pump</li> <li>Sample pump and Air sensor</li> <li>System pump A</li> <li>System pump A and Air sensor</li> </ul>	<ul style="list-style-type: none"> <li>Sample loop</li> <li>Superloop, 10 ml</li> <li>Superloop, 50 ml</li> <li>Superloop, 150 ml</li> </ul>

**Note:** In order to avoid sample carry-over when switching techniques for loading samples, wash the valve with buffer between the loading of two different samples. For example, when switching from loading sample in the loop to loading sample directly onto the column with the valve in **Direct inject** position.

When using a pump for sample application, it is important to prime inlets and purge the pump before using the pump to load the sample:

- Sample pump, see further instructions in [Section 5.4.2 Sample pump, on page 167](#)
- System pump A, see further instructions in [Section 5.4.1 System pumps, on page 161](#)

When loading sample using System pump A and an external air sensor, the sensor should be installed according to [Adapter for air sensor, on page 83](#).

**Note:** When sample is loaded at high flow rate and the external air sensor is placed before the pump that is used for loading the sample, it is necessary to use longer tubing to ensure that no air reaches the pump. Use tubing with the minimum lengths given below between the valve located before the pump and the external air sensor. The length applies for maximum flow rate, but shorter tubing can be used at lower flow rates.

- Sample pump S9: 40 cm.
- Sample pump S9H: 20 cm.

## 5.7.1 Sample application using direct injection onto the column

### Introduction

There are two ways to load sample directly onto a column:

- a fixed volume is loaded, or
- all the sample is loaded.

To inject all the sample, one of the following configurations is required:

- system pump, external air sensor, inlet valve A and the mixer valve, or
- sample pump and sample inlet valve.

### Minimize sample loss

To minimize sample loss during direct injection of sample onto the column, sample remaining in the flow path will be pushed onto the column with buffer from the inlet valve. This step is called **Finalize sample injection** in the text instructions of the sample application phase of the method to be used. Refer to [Section 5.9 Create a method and perform a run, on page 210](#) for more information on methods and phases.

When preparing to inject...	Then...
a fixed volume of sample	<ul style="list-style-type: none"><li>• manually prime the sample inlet tubing with sample, see <a href="#">Prime sample inlets, on page 167</a>.</li><li>• in the <b>Method editor</b>, make the following selections for the <b>Sample Application</b> phase of the method to be run:<ul style="list-style-type: none"><li>- select <b>Inject sample directly onto column</b>,</li><li>- select <b>Inject fixed sample volume</b> and set the volume to be injected.</li></ul></li><li>• make sure that the flow path from the sample inlet valve up to the injection valve will be filled with an appropriate buffer:<ul style="list-style-type: none"><li>- make sure that the buffer inlet tubing of the inlet valve is immersed in buffer, and</li><li>- enable the function <b>Wash sample flow path with buffer</b> in the <b>Sample application</b> phase.</li></ul></li></ul>

When preparing to inject...	Then...
all the sample	<ul style="list-style-type: none"> <li>in the <b>Method editor</b>, make the following selections for the <b>Sample Application</b> phase of the method to be run:               <ul style="list-style-type: none"> <li>select <b>Inject sample directly onto column</b>, and</li> <li>select <b>Inject all sample using air sensor</b>.</li> </ul> </li> <li>manually prime the sample inlet tubing with sample or buffer, see <a href="#">Prime sample inlets, on page 167</a>, and make sure that the tubing is immersed in sample before starting the run.</li> <li>make sure that the flow path from the sample inlet valve up to the injection valve is filled with sample or an appropriate buffer and that the buffer inlet tubing is immersed in buffer.</li> </ul>

## Maximize precision and accuracy

To achieve full precision and accuracy when a volume of sample is injected directly onto the column, make the following selections in the **Sample Application** phase of the method to be run (refer to [Section 5.9 Create a method and perform a run, on page 210](#) for more information on methods and phases):

- select **Inject sample directly onto the column**,

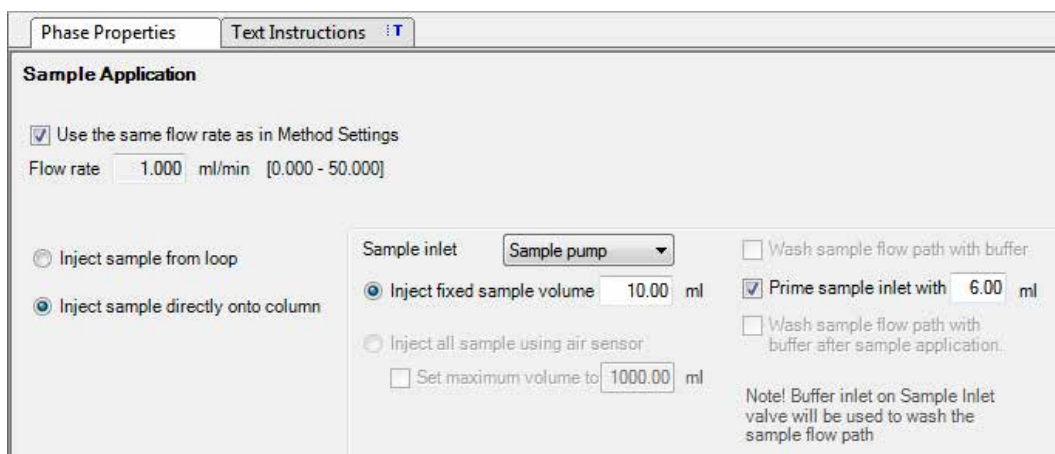

- select **Inject fixed sample volume** and set the volume to be injected,
- enable the function **Prime sample inlet with** and set the volume to be used for priming.  
*Result:* the step **Finalize sample injection** is automatically deactivated in order to maximize precision and accuracy. See [Minimize sample loss, on page 180](#) for more information.  
**Note:** If manual priming of the flow path up to the injection valve is preferred, enable **Prime sample inlet with** but set the volume to 0 ml.
- If the system pump is used to load the sample: enable the function **Wash sample flow path with buffer after sample application** in order to ensure that the correct sample volume is loaded onto the column.

## 5.7.2 Sample application using a Superloop™

### Introduction

A Superloop allows injection of large sample volumes onto the column. A Superloop can also be used for multiple injections, for example in a scouting experiment when the same application conditions are required. Superloop models are available in 10 ml, 50 ml and 150 ml sizes.

A superloop can be connected to either the Injection valve or the Loop valve. When using the Loop valve, up to five loops can be connected simultaneously.

**Note:** After loading a Superloop, always plug the **Syr** port on the Injection valve with a Stop plug. With a Superloop connected to the valve, an over-pressure may be created during injection.

---

### Prepare the Superloop

To avoid injecting air into the system flow path, the Superloop should be prefilled with buffer manually, before fitting the Superloop to the system.

**Note:** Read the instruction for the Superloop to be used.

---

### Connect the Superloop

Follow the instruction below to connect the Superloop to the Injection valve or to the Loop valve.

Step	Action
1	Attach the Superloop to the instrument using a Column holder.
2	Connect a piece of tubing from the <i>top</i> of the Superloop to: <ul style="list-style-type: none"><li>port <b>LoopE</b> on the Injection valve</li><li>or</li><li>a <b>E</b> port, eg., <b>1E</b>, on the Loop valve</li></ul>

Step	Action
3	Connect a piece of tubing from the <i>bottom</i> of the Superloop to: <ul style="list-style-type: none"> <li>port <b>LoopF</b> on the Injection valve</li> </ul>



or

- the **F** port corresponding to the connected **E** port, eg., **1F**, on the Loop valve

## Fill the Superloop using a syringe

Follow the instruction below to fill the Superloop using a syringe.

Step	Action
1	Check if the system is in state <b>Ready</b> . <ul style="list-style-type: none"> <li>If yes: The Injection valve is in position <b>Manual Load</b> per default. Continue to step 3.</li> <li>If no: Continue to step 2 to position the valve.</li> </ul>
2	In the <b>Process Picture</b> : <ul style="list-style-type: none"> <li>Click the <b>Injection valve</b> and select <b>Manual Load</b>.</li> </ul>

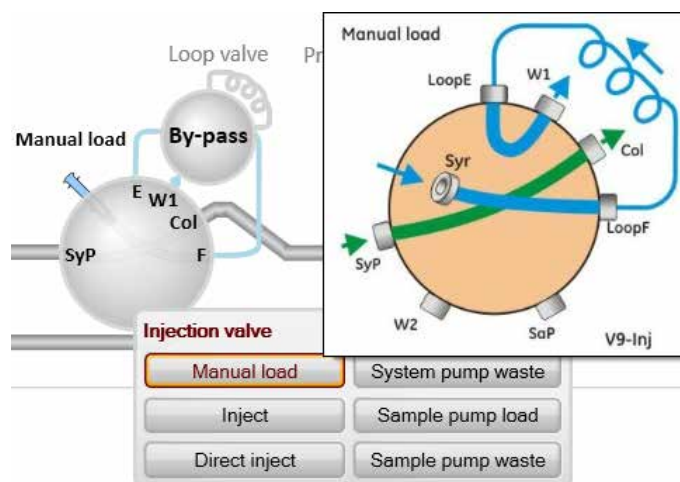

*Result:* The Injection valve switches to **Manual Load** position.

Step	Action
3	<p>If the loop is connected to:</p> <ul style="list-style-type: none"> <li>the Injection valve, continue to step 5.</li> <li>the Loop valve, continue to step 4.</li> </ul>
4	<p>In the <b>Process Picture</b>:</p> <ul style="list-style-type: none"> <li>Click the <b>Loop valve</b>.</li> <li>Select the position the loop is connected to, for example <b>Position 1</b>.</li> </ul> <div data-bbox="403 612 711 883" data-label="Image"> </div> <p><i>Result:</i> The Loop valve switches to the selected position.</p>
5	Fill a syringe with sample.
6	Connect the syringe to Injection valve port <b>Syr</b> .
7	Load sample into the Superloop by emptying the syringe into the Injection valve.
8	Disconnect the syringe and plug the <b>Syr</b> port with a Stop plug.

## Fill the Superloop using the Sample pump

Follow the instruction below to fill the Superloop using the Sample pump.



### NOTICE

**Glass tube splinter.** Make sure to set the sample pressure below the max pressure of the Superloop before executing a flow in the Manual instructions dialog when the Superloop is connected.

**Tip:** *The Superloop can also be filled as part of a method run, as set in the **Sample Application** phase in the **Method Editor**. For multiple injections, it may be more convenient to fill the Superloop once, as described in the instruction below.*

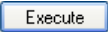
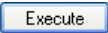

- | Step | Action   |
|------|--|
| 1    | <p>In the <b>Manual instructions</b> dialog:</p> <ul style="list-style-type: none"> <li>• Select <b>Flow path:Injection valve</b>.</li> <li>• Select <b>Sample pump load</b> from the <b>Position</b> drop-down list.</li> <li>• Click .</li> </ul> <p><i>Result:</i> The Injection valve switches to <b>Sample pump load</b> position.</p> |
| 2    | <p>Make sure that the sample inlet tubing from the sample vessel is connected to the Sample inlet valve.</p>   |
| 3    | <p>In the <b>Manual instructions</b> dialog:</p> <ul style="list-style-type: none"> <li>• Select <b>Alarms:Alarm sample pressure</b>.</li> <li>• Set <b>Mode</b> as <b>Enabled</b>.</li> <li>• Set a <b>High alarm</b> level that is below the maximum pressure of the Superloop.</li> <li>• Click .</li> </ul>                             |
| 4    | <p>In the <b>Manual instructions</b> dialog:</p> <ul style="list-style-type: none"> <li>• Select <b>Pumps and pressures:Sample flow</b>.</li> <li>• Set <b>Flow rate</b> to an appropriate value for the Superloop size, in this example 10 ml/min.</li> </ul>   |

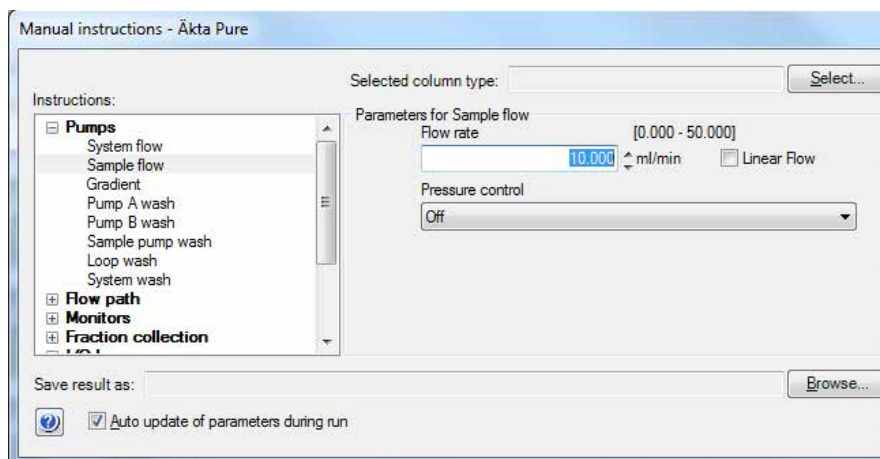

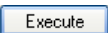
- Click .
- Result:* A sample flow starts, in this example of 10 ml/min.
- 5 When the Superloop is filled with as much volume as is needed, click the **End** icon in the **System Control** toolbar to end the run.



- 6 Plug the **Syr** port on the Injection valve with a Stop plug.

## Fill the Superloop using System pump A

Follow the instruction below to fill the Superloop using the System pump A. Note that Mixer valve has to be installed for this loop filling technique.



### NOTICE

**Glass tube splinter.** Make sure to set the system pressure below the max pressure of the Superloop before executing a flow, when the Superloop is connected.

**Tip:** The Superloop can also be filled as part of a method run, as set in the **Sample Application** phase in the **Method Editor**. For multiple injections, it may be more convenient to fill the Superloop once, as described in the instruction below.

Step	Action
------	--------

- |   |   |
|---|---|
| 1 | In the <b>Manual instructions</b> dialog: <ul style="list-style-type: none"><li>• Select <b>Alarms:Alarm system pressure</b>.</li><li>• Set <b>Mode</b> as <b>Enabled</b>.</li><li>• Set a <b>High alarm</b> level that is below the maximum pressure of the Superloop.</li><li>• Click <input type="button" value="Execute"/>.</li></ul> |
|---|---|

- |   |  |
|---|--|
| 2 | In the <b>Process Picture</b> : <ul style="list-style-type: none"><li>• Click the <b>Injection valve</b> and select <b>Sample pump load</b>.</li></ul> |
|---|--|

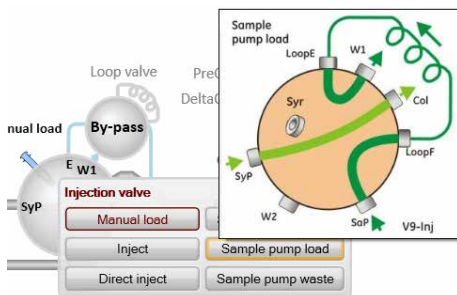

**Result:** The Injection valve switches to **Sample pump load** position.

**Step**      **Action**

- 3      In the **Process Picture**:
- Click the **Mixer valve** and select **By-pass**.

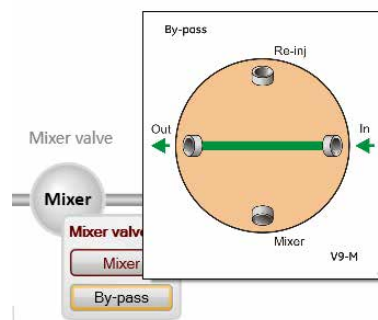

*Result:* The Mixer valve switches to **By-pass** position.

- 4      If the loop is connected to:
- the Injection valve, continue to step 6.
  - the Loop valve, continue to step 5.

- 5      In the **Process Picture**:
- Click the **Loop valve**.
  - Select the position the loop is connected to, for example **Position 1**.



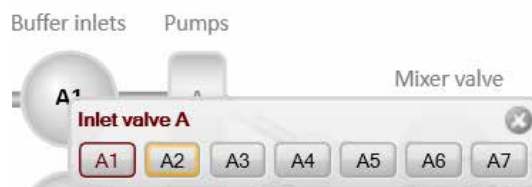

*Result:* The Loop valve switches to the selected position.

- 6      In the **Process Picture**:
- Click on the buffer inlet valve A.
  - Select the inlet position to be used for sample injection, for example **A2**.



*Result:* Inlet valve A switches to the selected port.

Step	Action
7	<p>In the <b>Process Picture</b>:</p> <ul style="list-style-type: none"><li>• Click on the <b>Pumps</b>.</li><li>• Set the <b>System flow</b> to an appropriate value for the Superloop size, in this example 10 ml/min.</li><li>• Click <b>Set flow rate</b>.</li></ul>  <p><i>Result:</i> A system flow starts, in this example of 10 ml/min.</p>
8	<p>When the Superloop is filled with as much volume as is needed, click the <b>End</b> icon in the <b>System Control</b> toolbar to end the run.</p> 
9	<p>Plug the <b>Syr</b> port on the Injection valve with a Stop plug.</p>

## 5.7.3 Sample application using a sample loop

### Introduction

A sample loop is recommended for injection of smaller sample volumes onto the column.

A sample loop can be connected to either the Injection valve or the Loop valve. When using the Loop valve, up to five loops can be connected simultaneously.

**Note:** Sample loop is called capillary loop in UNICORN.

### How to fill a sample loop

Follow the instructions below to fill the sample loop with sample.

Step	Action
1	Connect a suitable sample loop to Injection valve ports <b>LoopF</b> (fill) and <b>LoopE</b> (empty).



- 2 Fill a syringe with sample.
- 3 Connect the syringe to the Injection valve port **Syr**.



**Step**      **Action**

- 4            In the **Process Picture**:
- Click on the **Injection valve** and select **Manual load**.

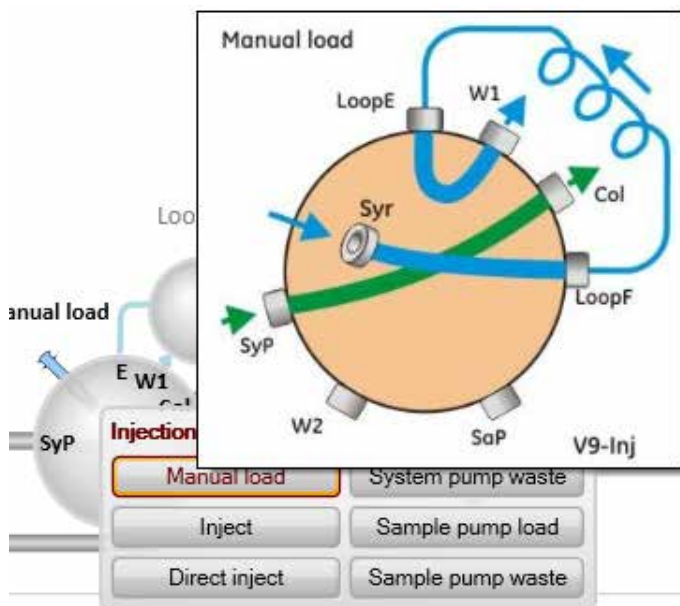

*Result:* Injection valve is set to manual load.

- 5            If the loop is connected to:
- the Injection valve, continue to step 7.
  - the Loop valve, continue to step 6.

- 6            In the **Process Picture**:
- Click the **Loop valve**.
  - Select the position the loop is connected to, for example **Position 1**.

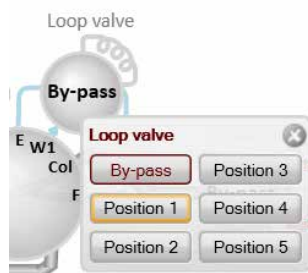

*Result:* The Loop valve switches to the selected position.

Step	Action
7	<p>Load sample into the sample loop. To avoid sample loss due to siphoning, leave the syringe in the port until the sample has been injected onto the column during the run.</p> <p><b>Tip:</b> <i>It is recommended to overfill the loop to make sure that the loop is completely filled. Excess of sample will leave the valve through port <b>W1</b>.</i></p>

## Fill the sample loop using the Sample pump

Most often the sample loop is filled using a syringe. However, to fill it using the sample pump, follow the instructions for filling the Superloop, see [Fill the Superloop using the Sample pump, on page 184](#).

- Note:**
- *It is not necessary to set the Alarm Sample Pressure when filling a sample loop.*
  - *It is recommended to overload the loop to make sure that the loop is completely filled.*
  - *Set **Flow rate** to an appropriate value for the loop size.*
  - *After loading, plug the **Syr** port on the Injection valve with a Stop plug.*

## Fill the sample loop using System pump A

Most often the sample loop is filled using a syringe. However, to fill it using System pump A, follow the instructions for filling the Superloop, see [Fill the Superloop using System pump A, on page 186](#).

## Empty the loop

### General considerations

During the method run, the sample is automatically injected onto the column. The loop is emptied and washed out using buffer from the system pumps. The total buffer volume to be used for emptying and washing the loop is set in the Method Editor.

### Using a sample loop connected to Loop valve V9-L or V9H-L

For maximum reproducibility, use complete loop fill when loading the loop, that is, overfill the loop with a sample volume of up to 3-5 times the volume of the loop. For minimum sample loss, use partial loop fill, that is, fill only up to 50% of the loop volume. Empty the loop with 3-5 times the volume of the loop.

### Volume used to empty a loop connected to Loop valve V9-L or V9H-L

To minimize the risk for carry over and to make sure that the complete sample volume reaches the column, the loop should be emptied with an excess of buffer. The tubing between the Loop valve port **E** and the Injection valve port **E** holds a small volume. If the loop is emptied with a volume equal to, or less than the loop volume this needs to be taken into account. It is also important to use a low flow rate to ensure that the correct volume is added to the column when injecting a small volume.

- Note:** *Partially emptying the loops that are attached to Loop valve V9-L or V9H-L can increase the risk for carry over from one loop position to the next.*

## 5.8 Fractionation

### Introduction

**Fraction collector F9-C** and **Fraction collector F9-R** collect fractions from ÄKTA pure purification runs. The fraction collectors are connected to ÄKTA pure and controlled by UNICORN. Control of the fraction collector can be achieved automatically in a method run, or manually.

---

### In this section

This section contains the following subsections:

Section	See page
5.8.1 Prepare Fraction collector F9-C	193
5.8.2 Prepare Fraction collector F9-R	199
5.8.3 Fractionation overview	206

---



## 5.8.1 Prepare Fraction collector F9-C

### About this section

This section describes how to prepare and assemble Fraction collector F9-C before a run.

The fraction collector is connected to ÄKTA pure and controlled by UNICORN. Control of the fraction collector can be achieved automatically in a method run, or manually.



#### CAUTION

**Fire Hazard. Do not fractionate flammable liquids using Fraction collector F9-C.**

When running RPC methods, or other procedures using organic solvents, collect fractions through the outlet valve or Fraction collector F9-R.

**Note:** *The tray and racks can tilt slightly when not fully inserted into the fraction collector and may harm the fractionation arm. The tilt is due to the height difference between the door and the floor of the fraction collector. The tendency to tilt is affected by the placement and weight of the cassettes, tubes or bottles*

### Prepare the fraction collector

Before starting to prepare Fraction collector F9-C, check the fractionation settings in the method to be run. Perform the steps described below according to the settings in the method.

- Insert the Cassette tray or a rack for tubes or bottles.
- Change the **System Settings** in UNICORN to set the fractionation mode and other settings for fraction collection.

How to insert a tray or a rack is shown below.

For information on how to change the **System Settings** before a run, see UNICORN System Control Manual. The available **System Settings** are described in the ÄKTA pure *User manual*.

## Prepare and insert the Cassette tray

Follow the instructions below to add cassettes to the Cassette tray and insert the tray into the fraction collector.

- | Step | Action  |
|------|---|
| 1    | If you are to use cassettes with the QuickRelease function, open the cassettes. For more information on the QuickRelease function see <a href="#">QuickRelease function, on page 98</a> . |



- |   |   |
|---|---|
| 2 | Place the tubes and deep well plates in the cassettes. Make sure that the deep well plates are rotated so that the well marked <b>A1</b> is positioned above the <b>A1</b> marking on the cassette. |
|---|---|



Step	Action
------	--------

3	Close the cassettes that have the QuickRelease function.
---	--



4	Place the cassettes on the Cassette tray. Make sure that the cassette type code (see illustration below) faces the front of the tray marked with the GE logo.
---	---

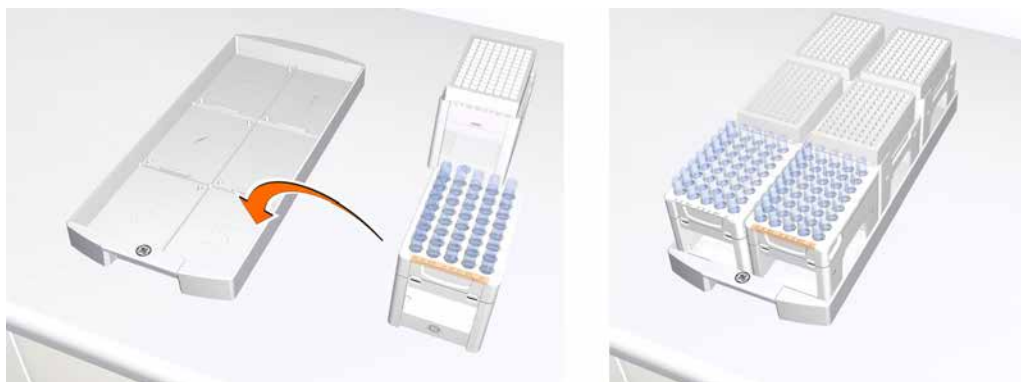

5	Open the door of the fraction collector using the handle.
---	---

Step	Action
------	--------

- |   |  |
|---|--|
| 6 | <p>Insert the tray into the fraction collector:</p> <ul style="list-style-type: none"><li>• make sure that the front of the tray (marked with the GE logo) faces outwards</li><li>• position the tray and slide it into the fractionation collector until it reaches the end</li></ul> |
|---|--|

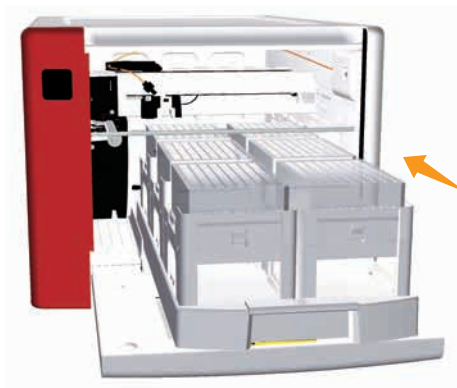

- make sure that the Tray catch snaps into closed position, as shown below.

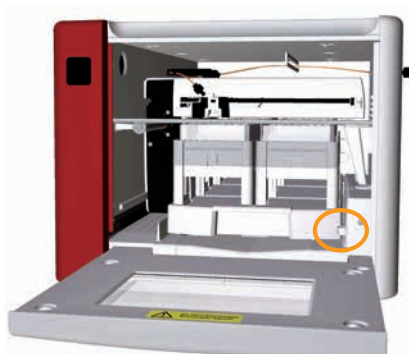

**Note:**

- *The tray can tilt slightly when not fully inserted into the fraction collector and may harm the fractionation arm. The tilt is due to the height difference between the door and the floor of the fraction collector. The tendency to tilt is affected by the placement and weight of the cassettes.*
- *A height exclusion bar ensures that the tubes or deep well plates are correctly positioned and cannot damage the Dispenser head.*

- |   |   |
|---|---|
| 7 | <p>Close the door. Make sure that it closes properly.</p> |
|---|---|

*Result:* After the door has been closed, the fractionation arm scans the cassette type code of each cassette to identify the cassette types. If deep well plates are used, the instrument also identifies the types of deep well plates.

**Note:**

*If the tray is inserted with the front of the tray facing the wrong way it will not be possible to close the door.*

## Prepare and insert a rack for tubes or bottles

Follow the instructions below to insert a rack for tubes or bottles into the fraction collector.

Step	Action
1	Place the tubes or bottles in the rack.
2	Open the door of the fraction collector using the handle.
3	Insert the rack into the fraction collector: <ul style="list-style-type: none"><li>• make sure that the front of the rack (marked with the GE logo) faces outwards</li><li>• position the rack and slide it into the fractionation collector until it reaches the end</li></ul>



- make sure that the Tray catch snaps into closed position, as shown below.

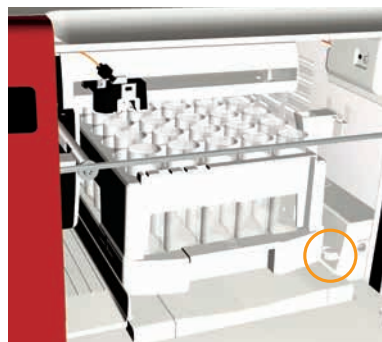

### Note:

- *The rack can tilt slightly when not fully inserted into the fraction collector and may harm the fractionation arm. The tilt is due to the height difference between the door and the floor of the fraction collector. The tendency to tilt is affected by the placement and weight of the tubes or bottles.*
- *A height exclusion bar ensures that the tubes or bottles are correctly positioned and cannot damage the Dispenser head.*
- *Do not use the Cassette tray when the Rack for 50 ml tubes or the Rack for 250 ml bottles is placed in the fraction collector.*

## 5 Operation

### 5.8 Fractionation

#### 5.8.1 Prepare Fraction collector F9-C

Step	Action
4	Close the door. Make sure that it closes properly.  <b>Note:</b> <i>If the rack is inserted with the front of the rack facing the wrong way it will not be possible to close the door.</i>

## 5.8.2 Prepare Fraction collector F9-R

### Introduction

This chapter describes how to prepare and assemble Fraction collector F9-R before a run.

Fraction collector F9-R is connected to ÄKTA pure and controlled by UNICORN. Control of the fraction collector can be achieved automatically in a method run, or manually.

### Prepare the fraction collector

Before starting to prepare the Fraction collector F9-R, check the fractionation settings in the method to be run. Perform the steps described below according to the settings in the method.

- Assemble the Tube rack
- Insert collection tubes
- Adjust the Delivery arm
- Update **System Settings** in UNICORN

### Assemble the Tube rack

#### Illustration of the Tube rack

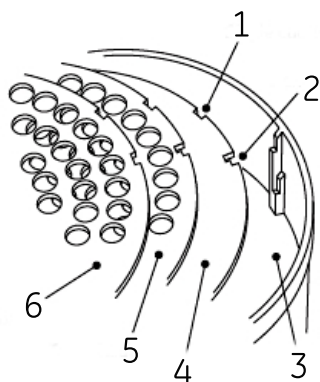

Part	Function
1	Single cutout
2	L-shaped cutout
3	Bowl
4	Tube support
5	Tube guide
6	Tube holder

**Note:** Note that the tube guide has both single and L-shaped cutouts, while the tube holder only has single cutouts.

### Tube rack inserts

The Fraction collector F9-R is delivered with the 18 mm tube rack mounted. Each tube rack is made up of a combination of a Bowl, Tube support, Tube guide and Tube holder. Change the Tube holder and the Tube guide to collect fractions in 12 mm tubes or 30 mm tubes. The 12 mm tube rack is delivered with ÄKTA pure and the 30 mm tube rack is available as an accessory. The table below describes inserts and corresponding fraction collection tubes.

Inserts	Maximum number of tubes	Tube diameter	Tube length
12 mm Tube holder 12 mm Tube guide	175	12 mm	50 - 180 mm
18 mm Tube holder 18 mm Tube guide	95	18 mm	50 - 180 mm
30 mm Tube holder 30 mm Tube guide	40	30 mm	50 - 180 mm

### Single and L-shaped cutouts

When assembling a tube rack, different cutouts are used for the various inserts depending on the length of the collection tubes. Which cutouts to use are summarized in the tables below.

#### 12 mm and 18 mm Tube rack inserts

Inserts	50 - 85 mm tubes	85 - 180 mm tubes
Tube support	L-shaped cutout	Not required
Tube guide	Single cutout	L-shaped cutout
Tube holder	Single cutout	Single cutout

#### 30 mm Tube rack inserts

Inserts	30 - 50 mm tubes <sup>1</sup>	50 - 85 mm tubes	85 - 180 mm tubes
Tube support	Single cutout	L-shaped cutout	Not required
Tube guide	Single cutout	Single cutout	L-shaped cutout
Tube holder	Single cutout	Single cutout	Single cutout

<sup>1</sup> For 30-50 mm tubes, first insert the tube guide from the 18 mm rack using the single cutout, before inserting the tube support for the 30 mm rack.



## Assembly instructions

Follow the instructions below to assemble the Tube rack.

- | Step | Action  |
|------|---|
| 1    | Insert the Tube support (4), if required, into the bowl (3). The circular marks on the Tube support should face down. |

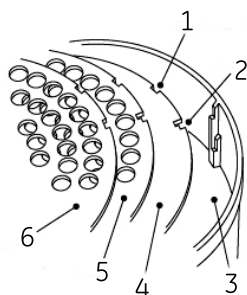

### Note:

When assembling a Tube rack, Single cutouts (1) and L-shaped cutouts (2), are used for various inserts depending on the length of the collection tubes. See [Single and L-shaped cutouts, on page 200](#) for detailed information.

- |   |   |
|---|---|
| 2 | Insert the Tube guide (5) with the tube position numbers upwards. The Tube guide should rest about 1 cm above the Tube support.                               |
| 3 | Insert the Tube holder (6) with the tube position numbers upwards:<br>Check that tube position 1 (7) is directly above tube position 1 (7) of the Tube guide. |

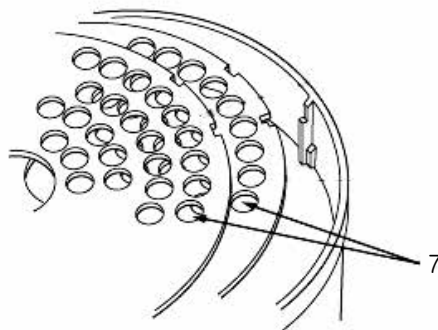

Step	Action
4	<ul style="list-style-type: none"><li>• Push the flexible bowl out at each rib and snap the Tube holder under the top lip of the rib (8).</li></ul>

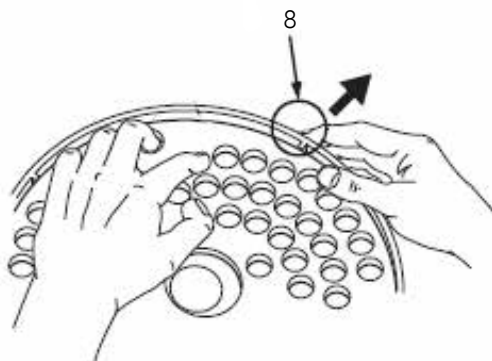

**Note:**

*Do not force the tube holder into place as this may damage the lip.*

- Check that the surface of the Tube holder is level.
- 5 Gently move the Delivery arm (10) out to the outer stop.
- 6 Place the Tube rack (9) over the Central spindle (11) and pull the spring loaded Drive sleeve (12) out so the Tube rack comes to rest.

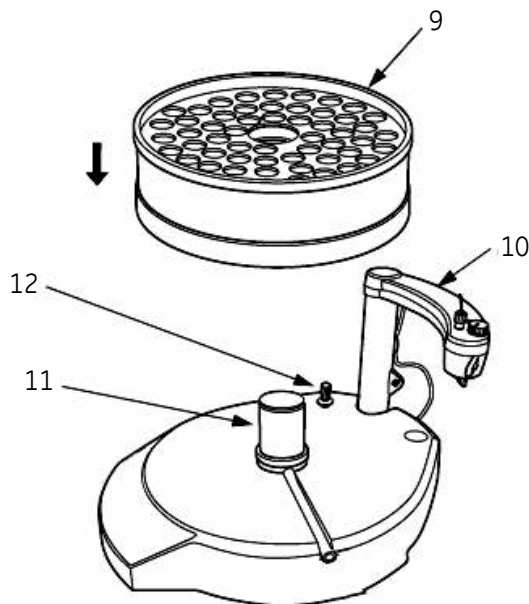

## Insert collection tubes

Insert a sufficient number of collection tubes in to the Tube rack, starting at position 1, pushing each one down as far as they will go. All the tubes must be of the same length and diameter and there should be no spaces in the sequence.

---

## Adjust the Delivery arm

Follow the instructions in the table below to adjust the height of the Delivery arm.

Step	Action
1	Lift and then lower the Delivery arm (1), and allow it to move in so the Tube sensor (2) touches the collection tubes of the outer track.

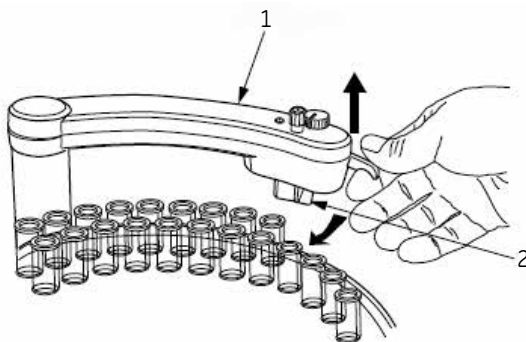

2	Loosen the lock knob (3)
---	--------------------------

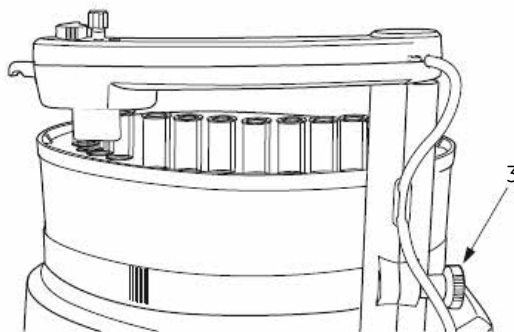

- | Step | Action   |
|------|--|
| 3    | <ul style="list-style-type: none"><li>Adjust the height so that the horizontal mark (5) on the Tube sensor (6) is at the same level as the top of the flat collection tubes and approximately 2 mm over the top of the flanged collection tubes (4).</li></ul> |

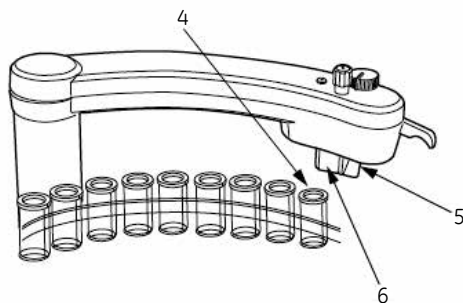

- Lock the Delivery arm at this height with the lock knob.
- 4 Check that the Tube sensor (9) is in the correct position for the tubes used (10). The eluent tubing (7) should be above the center of the collection tube.

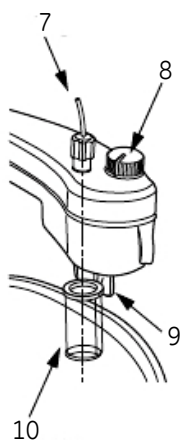

- 5 Use the Sensor control (8) to position the Tube holder over the center of the collection tube.



**NOTICE**

Never lift **Fraction collector F9-R** by the Delivery arm. This may damage the Fraction collector.

## Sensor control

The sensor control can be switched between the two positions "small tubes" and "large tubes", indicated in the illustration below.

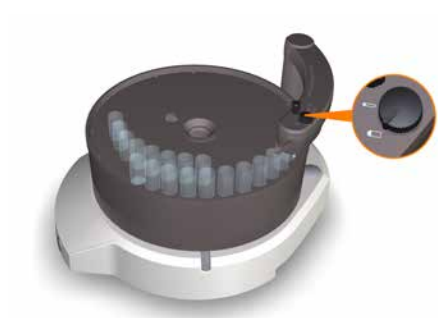

The position for large tubes is used for tubes of approximately 18 mm i.d. and larger. The position for small tubes is used for tubes smaller than 18 mm i.d.

Note that this is a rough approximation. Always check that the eluent tubing is centered above the collection tube.

---

## 5.8.3 Fractionation overview

### Fractionation types

The table below lists the types of fractionation that the fraction collectors can be used for.

Type	Description
Fixed volume fractionation	During fixed volume fractionation the fraction collector continuously switches tubes according to the set volume throughout the entire fractionation. This type of fractionation is also known as straight fractionation.
Peak fractionation	Peak fractionation can be used to further increase the purity of the collected protein peaks and minimize the number of tubes used. The monitor signal is used to determine when to switch the tubes. See <a href="#">Section 9.8.10 System settings - Watch parameters, on page 462</a> for information about different watch options.
Combined fixed volume fractionation and peak fractionation	The two fractionation types listed above can be used in combination. Combination of fixed volume and peak fractionation allows fractions collected by fixed volume fractionation and fractions collected by peak fractionation to be directed to different collection tubes.

To be able to analyze different parts of the peak, the fraction size during elution is usually set to a value smaller than the expected peak volume.

#### Illustration

The illustration below shows examples of fractionation using fixed volume fractionation and fractionation using peak fractionation.

A) Straight/fixed fractionation

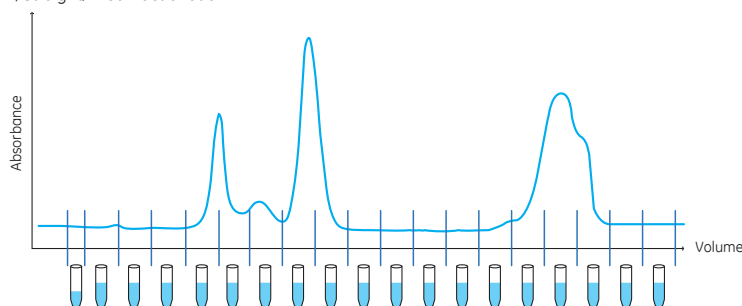

B) Peak fractionation

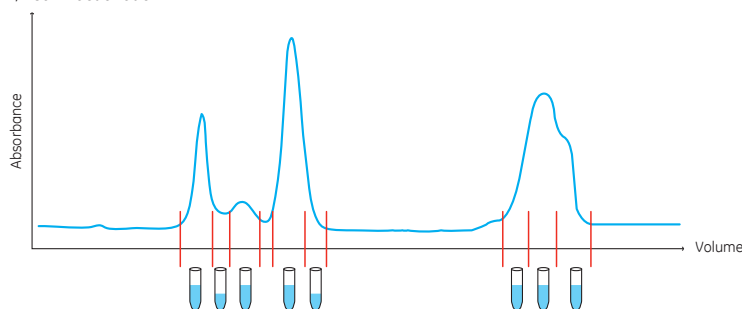

## Delay volume

### Description

The delay volume settings are used to make sure that the fractions collected during fractionation, using the outlet valve or the fraction collector, correspond to the fractions indicated in the chromatogram. The delay volume is the volume between the UV monitor, and the fraction collector or outlet that is used, see the illustration below.

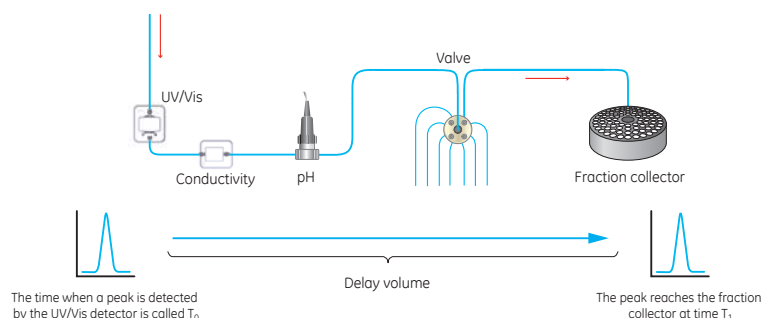

As the delay volume is affected by the length and diameter of the tubing, it should be set according to the tubing and modules used.

### Illustration of fraction marking using fixed volume fractionation

The illustration below shows the fractions collected, and the numerical marking of fractions, when fixed volume (straight) fractionation is used with Fraction collector F9-R.

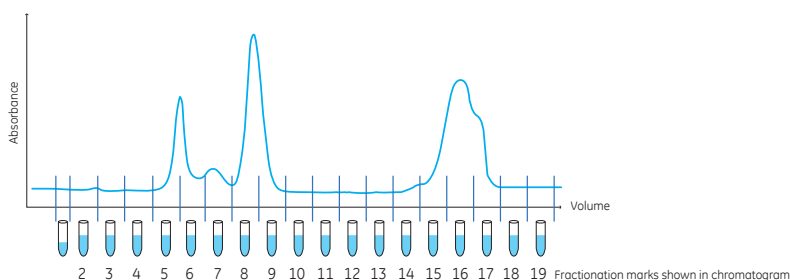

When fixed volume fractionation is used the delay volume is collected at the beginning of fractionation. Fraction collector F9-R saves the delay volume in the first fraction (fraction 1), see the example illustration above. Delay volumes are not indicated with a numerical fraction mark on the chromatogram. Fraction collector F9-C does not save the delay volume as a fraction, instead the delay volume is disposed of in the waste funnel.

**Note:** If two fraction collectors are used, the fractions collected by Fraction collector F9-R, 2nd are indicated by the prefix 2: (i.e. fractions 2:1, 2:2, 2:3 etc.).

### Illustration of fractions and fraction marking using peak fractionation

The illustration below shows the fractions collected, and the numerical marking of fractions, when peak fractionation is used with Fraction collector F9-R.

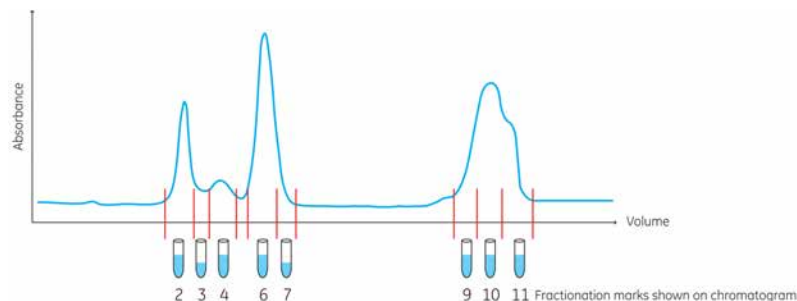

When peak fractionation is used, Fraction collector F9-R collects the delay volumes in the fractions preceding each peak. In the chromatogram above, delay volumes are collected in fractions 1, 5 and 8. The numerical fraction marks for the delay volume fractions are not indicated on the chromatogram. Fraction collector F9-C does not save the delay volumes as fractions, instead the delay volumes are disposed of in the waste funnel.

**Note:** If two fraction collectors are used, the fractions collected by the second Fraction collector are indicated by the prefix 2: (i.e. fractions 2:1, 2:2, 2:3 etc.).

---

### Fractionation modes for Fraction collector F9-C

There are three fractionation modes for Fraction collector F9-C, **Automatic**, **Accumulator** and **DropSync**. Spillage between collection vessels during a run is avoided with all three fractionation modes.

- **Automatic:** The fraction collector uses the Drop Sync mode for flow rates up to 2 ml/min and automatically switches to Accumulator mode for higher flow rates.
- **Accumulator:** Liquid is collected during movement between tubes or wells. The liquid is then dispensed in the next well or tube. Fractionation with accumulator can be used at all flow rates.
- **DropSync:** When using DropSync, the sensors in the Dispenser head detect when a drop is released from the nozzle. The Dispenser head moves to the next well or tube just after a drop is released. Fractionation with DropSync can be used at flow rates up to 2 ml/min. If only one Cassette is used and it is placed near the waste funnel, DropSync can be used at higher flow rates. Volatile solutions and solutions with low surface tension may require a lower flow.

---

### Fractionation settings for Fraction collector F9-R

There are two fractionation settings for Fraction collector F9-R, **DropSync off** or **DropSync on**.

**DropSync off:** No synchronization of collection.



**DropSync on:** When using **DropSync** the sensors in the Tube sensor detect when a drop is released. The Tube rack moves and positions the next tube under the Tube sensor just after a drop is released. Fractionation with **DropSync** can be used at flow rates up to 2 ml/min. For water and solutions with higher surface tension, a higher flow rate can be used. Volatile solutions and solutions with low surface tension may require a lower flow.

---

## Missing tubes in Fraction collector F9-R

If a tube is missing, Fraction collector F9-R will continue the fractionation on the tube row located closer to the center of the fraction collector. The fractionation marks in the chromatogram will then not reflect the tubes in which the sample is collected.

If the fraction collector runs out of tubes, the delivery arm moves to the fraction collector center position while ÄKTA pure pauses and displays an error message.

---

## Missing tubes or plates in Fraction collector F9-C

When automatic cassette configuration is selected in the system settings the fraction collector automatically detects which types of cassettes and plates that are present. The fraction collector will however not detect if tubes or bottles are missing in the cassettes. Make sure that the cassettes to be used are occupied by appropriate types and numbers of tubes or bottles before starting a run.

It is not possible to change the cassette configuration during a run. When the system state is set to **Pause** it is possible to take out cassettes or plates from the fraction collector only if they are replaced by cassettes or plates of the same type and are placed in the same positions.

The action of the system when the last tube in the fraction collector is filled is set in the instruction **Last tube filled** in the system settings. The flow can be directed to waste or to any of the outlets or the run can be paused. If the action is set to **Pause**, the system automatically pauses when the last tube is filled and prompts the user to replace the filled tubes.

---

## Peak broadening

The width of peaks at the fraction collector is influenced by the properties of the column and the dimensions of tubing connecting the components. Initial sample volume affects the peak width in gel filtration (GF) chromatography. A sample zone is broadened during passage through a GF column so that the sample is diluted and the resolution decreases with increasing sample volume. Sample volume does not however affect the resolution in adsorption chromatography techniques such as affinity chromatography (AC), ion exchange chromatography (IEX), and hydrophobic interaction chromatography (HIC). The effect of peak broadening in the system from sample injection to peak detection (including dilution on the column) is apparent in the chromatogram from the UV monitor, but broadening from the UV monitor to fraction collection is not visible in the chromatogram. This "hidden" effect can sometimes be dramatic, especially for high-resolution columns.

To minimize peak broadening, use narrow and short tubing connections as far as possible. Remember that using narrow tubing will increase the back pressure in the system.

---

## 5.9 Create a method and perform a run

### Introduction

This section provides an overview of how to create a method in UNICORN and how to perform manual and method runs on ÄKTA pure.

It also contains advice on things to be considered during a run.

---

### In this section

This section contains the following sub-sections:

Section	See page
5.9.1 Create a method	211
5.9.2 Prepare and perform a run	216
5.9.3 Monitor a run	218
5.9.4 After run procedures	220

---

## 5.9.1 Create a method

### Introduction

The predefined methods are built up using phases, where each phase corresponds to a step in a chromatography run with a number of properties associated with that phase.

See UNICORN Method Manual for more information about method structure, definitions and concepts of methods in UNICORN.

---

### Predefined methods

There are several predefined methods to choose from. All the predefined methods are listed below.

The predefined methods available for each system are defined by the Instrument Configuration. Refer to [Section 9.7 Predefined methods and phases, on page 438](#) for more information about each method.

#### Purification methods

- Affinity Chromatography (AC)
- Affinity Chromatography (AC) with Tag Removal
- Anion Exchange Chromatography (AEX)
- Cation Exchange Chromatography (CEX)
- Chromatofocusing (CF)
- Desalting
- Gel filtration (GF)
- Hydrophobic Interaction Chromatography (HIC)
- Manual Loop Fill
- NHS-coupling
- Reversed Phase Chromatography (RPC)

#### Maintenance methods

- Column CIP
  - Column Performance Test
  - Column Preparation
  - System CIP
  - System Preparation
- 

### Main steps when defining a new method

The main steps when defining a method are:

- 1 Create/open a method
  - Create a **Predefined** method (including a set of phases that may be edited)

## 5 Operation

### 5.9 Create a method and perform a run

#### 5.9.1 Create a method

or

- Open an existing method that can be edited and saved with a new name or overwritten
- 2 Build/edit the **Method Outline** and/or edit the **Phase Properties** for the appropriate phases
  - 3 Save the method
- 

## Create a new method

Follow the instructions below to create a new method.

Step	Action
------	--------

- |   |   |
|---|---|
| 1 | In the <b>Method Editor</b> : <ul style="list-style-type: none"><li>• click the <b>Create a new method</b> icon in the <b>Toolbar</b></li></ul> |
|---|---|



or

- select **File:New Method...**

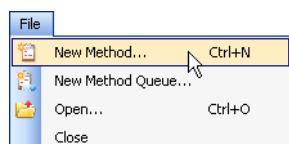

Result: The **New Method** dialog opens.

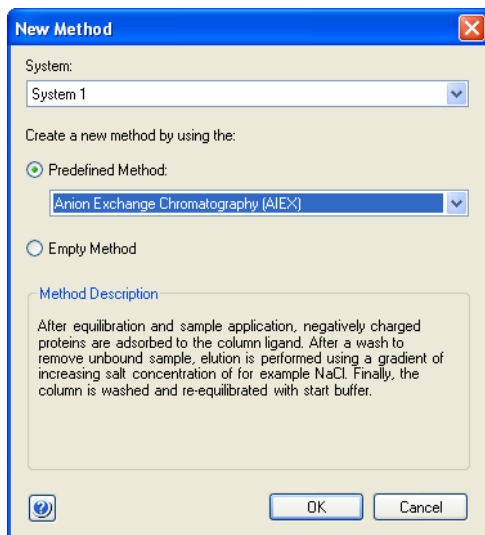

**Step**      **Action**

- 2            In the **New Method** dialog:
- select a **System**
  - select a **Predefined Method**
  - click **OK**

*Result:* The **Method Outline** pane shows the included phases for the chosen method and the **Phase Properties** pane shows the default settings for the currently highlighted phase.

See UNICORN Method Manual for more information about methods and method creation in UNICORN.

**Note:**    *Sample loop is called capillary loop in UNICORN.*

## Text Instruction mode

In most cases methods can be edited using the **Phase Properties** pane in the **Method Editor** module. However, modules without a recommended position are not supported by **Phase Properties** and have to be edited in the **Text Instruction** mode.

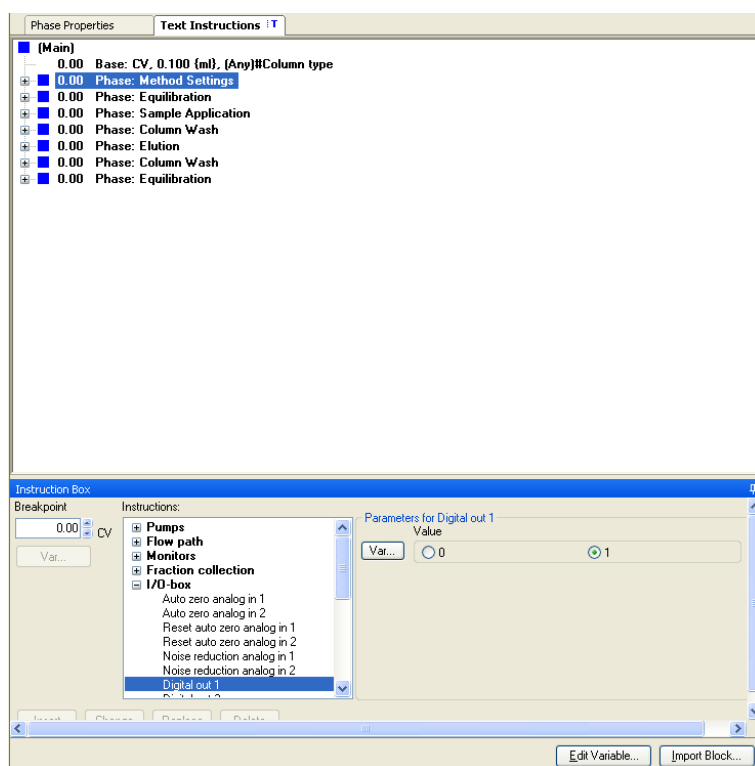

The following modules require that the method is created using the **Text Instruction** mode:

- Inlet valve IX

**Note:**    *When using Inlet valve IX (V9-IX or V9H-IX) connected to another inlet valve in a run, it is necessary to use the instructions for both Inlet valve IX and the other inlet valve, respectively.*

## 5 Operation

### 5.9 Create a method and perform a run

#### 5.9.1 Create a method

- Versatile valve
- I/O-box
- UV monitor, 2nd

**Note:** It is possible to reset the UV monitor **U9-L, 2nd** using **Phase Properties**. All other UV monitor **U9-L, 2nd** instructions need to be edited in the **Text Instruction** mode.

**Note:** If installing more than one external air sensor, it is necessary to create the methods for the additional air sensors using the **Text Instruction** mode.

---

## Open and save methods for different systems

New ÄKTA pure methods are always created for the set of components of the current system. Methods can be shared between systems, with the restriction that a method created for an ÄKTA pure 150 configured system cannot be used with an ÄKTA pure 25 configured system, and vice versa.

When a method is opened for a system that has been changed or if a method is saved for a system with a different flow configuration, a dialog is opened where the user can choose to either adapt the method or to keep the text method unchanged.

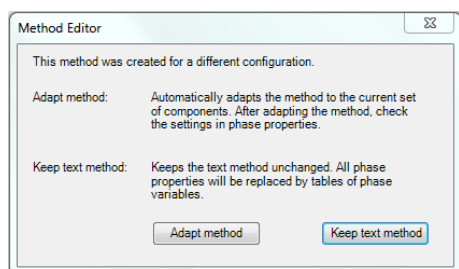

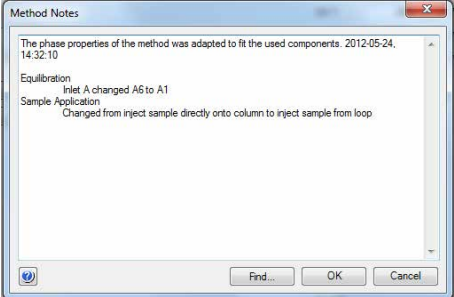
If you select..	Then..
<p><b>Adapt method</b></p>	<p>the method will be adapted to the new set of components. All functions and positions that are still available will be unchanged. For example, valve positions present on both the original and the new system will be unchanged in the adapted method. Non-compatible settings will be adjusted in order to properly adapt the method for new components. Settings that have been changed are described and saved in <b>Method Notes</b>, which are displayed after the method has been adapted.</p>  <p>Change the settings in <b>Phase Properties</b> if required.</p> <p><b>Note:</b>  <i>Some predefined methods require certain components to be functional. Adapting these methods to systems that do not include the required components is not possible.</i></p>
<p><b>Keep text method</b></p>	<p>the text method will be kept and nothing will be changed. Non-compatible settings will still be present in the method but they will not be functional. All <b>Phase Properties</b> of the method will be replaced by tables of <b>Phase Variables</b>.</p>

## 5.9.2 Prepare and perform a run

### Introduction

This section describes how to start a run using a previously created method and how to perform a manual run. For further information about the capabilities of the **System Control** module, refer to *UNICORN System Control Manual*.

### Choose and start a method

The following instruction describes how to open a method and start a run.

#### Step

#### Action

- 1 Open the **System Control** module and click the icon **Open Method Navigator**.



*Result:* The **Method Navigator** pane opens.

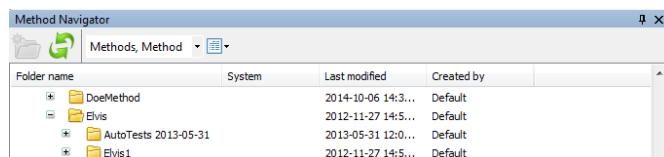

- 2 Select the method to run, and click the **Run** icon.



*Result:* The **Start Protocol** dialog opens.

- 3 Step through the displayed pages in the **Start Protocol**, add requested input and make appropriate changes if necessary. Click **Next**.

- 4 Click **Start** on the last page of the **Start Protocol**.

*Result:*

- If column logging was chosen during installation of UNICORN and a column type was selected when the method was created, the **Select Columns** dialog opens. For further information on column handling, please refer to *UNICORN Method Manual* and *UNICORN System Control Manual*.
- If column logging was *not* chosen during installation of UNICORN and/or *no* column type was selected when the method was created, the run starts directly.



## Perform a manual run

Manual runs can be convenient for procedures such as filling tubing with buffer or packing a column with media.

- | Step | Action  |
|------|---|
| 1    | On the <b>Manual</b> menu, click <b>Execute Manual Instructions</b> . |
| 2    | Select instruction group and instruction.                             |
| 3    | Select or enter parameter values.                                     |

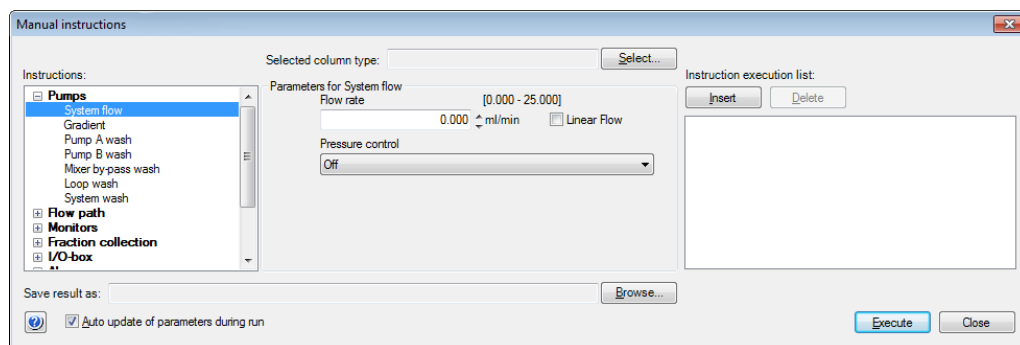

- 4 Click **Insert** to have several instructions performed at the same breakpoint.

**Note:**

Manual runs are only stored temporarily. However, you can choose to store them permanently in a selected directory. To save results in a chosen directory, click **Browse** before the run is started.

**Note:**

If a method run is started during a manual run, the results from the manual run are not stored.

- 5 To perform the instructions, click **Execute**.

## 5.9.3 Monitor a run





### Introduction

During the run, the **System Control** module will display the run progress of the method being executed. This section describes how to interact with the run from the process picture or by executing manual instructions.

To find an overview of the **System Control** user interface, see UNICORN System Control Manual.

### Monitor the run

To interrupt a method during a run you may use the **Hold**, **Pause** or **End** icons in **System Control**. A held or paused method run can be resumed by using the **Continue** icon. See the instructions in the table below.

If you want to...	then...
temporarily hold the method, with current flow rate and valve positions sustained	click the  button.
temporarily pause the method, and stop all pumps	click the  button.
resume, for example, a held or paused method run.	click the  button. <b>Note:</b> <i>An ended method cannot be resumed.</i>
permanently end the run	click the  button.

**Note:** *When ending a method run in advance, it is possible to save the partial result.*

More information regarding UNICORN capabilities during the method run is available in the UNICORN System Control Manual.

## Actions in the process picture pane

It is possible to manually interact with an ongoing method through the **Process Picture**, see UNICORN System Control Manual.

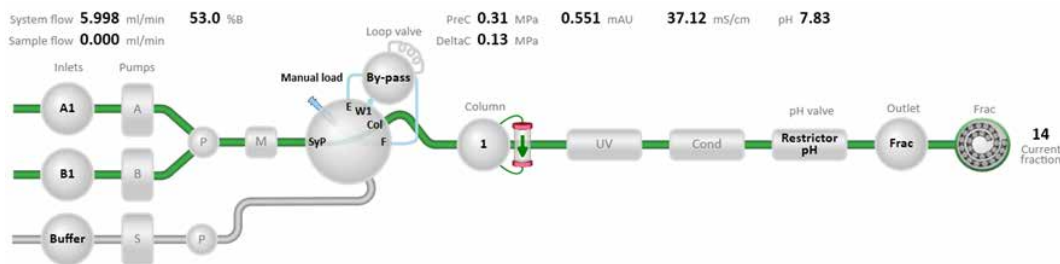

## Using UNICORN to control the pressure during a run

The function **Pressure control** allows a method to be run with the set flow rate without the risk of a method stop due to pressure alarm. Pressure control is enabled in the instructions **System flow** and **Sample flow**. Refer to [Section 9.15 Pressure control, on page 500](#) for more information.

## The system configuration affects the pressure

Using narrow tubing between components will improve resolution but will lead to increased back pressure in the system. Narrow tubing after the column will increase the pressure in the column at a given flow rate. Make sure that the sensor limits for the pre-column pressure are set so that the maximum pressure for the column in use is not exceeded.

**Note:** If Column valve **V9-C** or **V9H-C** is mounted, the integrated pressure sensor of the valve allows the system to monitor the post-column pressure. The limit for the pressure sensor in Column valve **V9-C** or **V9H-C** is automatically set so that the UV monitor and the pH monitor are protected from high pressure. If Column valve **V9-C** or **V9H-C** is not mounted, make sure to keep the pressure in the system after the column below the pressure limits for the modules in the flow path.

## 5.9.4 After run procedures

### Introduction

This section describes how to clean the instrument and columns after a chromatographic run, and how to prepare the system for storage.

The instrument and the columns should be cleaned between the runs. This will prevent, for example, sample contamination, protein precipitation and column clogging. If the instrument is not going to be used for a couple of days or longer, the instrument, columns and the pH flow cell should be filled with storage solution. For further information about cleaning and maintenance procedures, see [Chapter 7 Maintenance, on page 251](#).

**Tip:** To clean and fill the instrument and columns with storage solution, use **System CIP** and **Column CIP** either as separate, predefined methods or as phases included in a chromatographic method.



#### CAUTION

**Hazardous chemicals and biological agents.** Before maintenance, service and decommissioning, wash the ÄKTA pure instrument with a neutral solution to make sure that any hazardous solvents and biological agents have been flushed out from the system.

### System cleaning

After a method run is completed, perform the following:

- Rinse the instrument with one or several cleaning solution(s) (e.g., NaOH, buffer solution or distilled water) using **System CIP**.

**Note:** If Column valve **V9-C** or **V9H-C** is mounted, the integrated pressure sensor of the valve allows the system to monitor the post-column pressure. The limit for the pressure sensor in Column valve **V9-C** or **V9H-C** is automatically set so that the UV monitor and the pH monitor are protected from high pressure. If Column valve **V9-C** or **V9H-C** is not mounted, make sure to keep the pressure in the system after the column below the pressure limits for the modules in the flow path.

- If applicable, empty the fraction collector.
- Clean all spills on the instrument and on the bench using a moist tissue.
- Empty the waste vessel.
- Clean the manual injection port of the injection valve, see [Section 7.6.2 Perform System CIP, on page 278](#) for detailed instructions.
- If applicable, clean the pH electrode manually and make sure to leave it in an appropriate buffer. See [Section 7.6.7 Clean the pH electrode, on page 293](#) for detailed instructions.

## System storage

If the instrument is not going to be used for a couple of days or longer, also perform the following:

- Fill the system and inlets with storage solution (e.g., 20% ethanol) using **System CIP**.  
**Note:** *If Column valve **V9-C** or **V9H-C** is mounted, the integrated pressure sensor of the valve allows the system to monitor the post-column pressure. The limit for the pressure sensor in Column valve **V9-C** or **V9H-C** is automatically set so that the UV monitor and the pH monitor are protected from high pressure. If Column valve **V9-C** or **V9H-C** is not mounted, make sure to keep the pressure in the system after the column below the pressure limits for the modules in the flow path.*
  - If applicable, prepare the pH electrode for storage as described in [Section 7.6.6 Storage of the pH electrode, on page 291](#).
- 

## Column cleaning

After a method run is completed, perform the following:

- Clean the column with one or several cleaning solution(s) using **Column CIP**.
- 

## Column storage

If the column is not going to be used for a couple of days or longer, also perform the following:

- Fill the column with storage solution (e.g., 20% ethanol) using **Column CIP**.
- 

## pH electrode storage

If pH monitoring will not be used for a week or longer, perform one of the following actions:

- Inject new storage solution into the pH flow cell. Refer to [Section 7.6.6 Storage of the pH electrode, on page 291](#) for instructions.
- Replace the pH electrode with the dummy electrode that is installed in the pH valve on delivery.

In the following situations, in order to increase the lifetime of the pH electrode, use the **By-pass** position and store the electrode in storage solution inside the pH flow cell:

- pH monitoring is not needed during the run.
- Organic solutions are used.
- Extremely acidic or extremely basic solutions are used.

For further information on how to prepare the pH electrode for storage, refer to [Section 7.6.6 Storage of the pH electrode, on page 291](#).

---

## Log off or exit UNICORN

Follow the instructions to log off or exit UNICORN. This can be performed from any of the UNICORN modules.

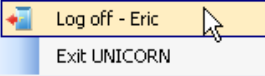
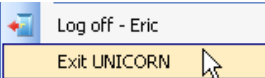
If you want to...	then...
log off UNICORN	<p>on the <b>File</b> menu, click <b>Log off</b>.</p>  <p><i>Result:</i> All open UNICORN modules close and the <b>Log On</b> dialog box opens.</p>
exit UNICORN	<p>on the <b>File</b> menu, click <b>Exit UNICORN</b>.</p>  <p><i>Result:</i> All open UNICORN modules close.</p>

**Note:** If an edited method or result is open and not saved when you try to exit or log off UNICORN, you will see a warning. Click **Yes** to save, **No** to exit without saving, or **Cancel** to stay logged on.

## Shut down the instrument

Switch off the instrument by pressing the power switch to the **O** position.



# 6 Performance tests

## About this chapter

This chapter provides information about performance tests.

Performance tests should be run after installation to check the function of the ÄKTA pure system. Different tests are available and the tests to perform depend on the system configuration used.

Performance tests can also be used at any time to check the condition of the system, for example, after a prolonged stop. This chapter describes how to prepare, run, and evaluate the different performance tests available.

## In this chapter

This chapter contains the following sections:

Section	See page
6.1 General performance test actions	225
6.2 Air sensor A and Inlet valve A tests	228
6.3 Air sensor B and Inlet valve B tests	230
6.4 Air sensor S and Sample inlet valve tests	232
6.5 Column valve C tests	234
6.6 Fraction collector F9-C test	236
6.7 Fraction Collector F9-R Test	239
6.8 Sample pump tests	241
6.9 System Test UV U9-L (fixed)	243
6.10 System Test UV U9-M (variable)	247



## 6.1 General performance test actions

### Introduction

Some actions are identical for each performance test. These actions are described in this section.

### Start the performance tests

Follow the instructions to start a performance test.

- | Step | Action   |
|------|--|
| 1    | In the <b>System Control</b> module, on the <b>System</b> menu, click <b>Performance Test and Report</b> .<br><i>Result:</i> The <b>System Performance Test and Report</b> dialog opens. |
| 2    | In the <b>System Performance Test and Report</b> dialog, click one of the following tests:   |

ÄKTA pure 25	ÄKTA pure 150
<b>Air sensor A and inlet valve V9-IA test</b>	<b>Air sensor A and inlet valve V9H-IA test</b>
<b>Air sensor B and inlet valve V9-IB test</b>	<b>Air sensor B and inlet valve V9H-IB test</b>
<b>Air sensor S and Sample inlet valve V9-IS test</b>	<b>Air sensor S and Sample inlet valve V9H-IS test</b>
<b>Column valve V9-C test</b>	<b>Column valve V9H-C test</b>
<b>Fraction Collector F9-R Test</b>	<b>Fraction Collector F9-R Test</b>
<b>Fraction Collector F9-C Test</b>	<b>Fraction Collector F9-C Test</b>
<b>Sample pump S9 test</b>	<b>Sample pump S9H test</b>
<b>System Test UV U9-L (fixed)</b>	<b>System Test UV U9-L (fixed)</b>
<b>System Test UV U9-M (variable)</b>	<b>System Test UV U9-M (variable)</b>

- |   |  |
|---|--|
| 3 | Click <b>Run Performance Method</b> .<br><i>Result:</i> The <b>Start Protocol</b> dialog of the selected test opens.   |
| 4 | Click <b>Next</b> in the <b>Start Protocol</b> dialog to open the next page. The pages are described in the table <a href="#">Overview of the Start Protocol dialog, on page 226</a> . |
| 5 | In the last page, <b>Result name and location</b> , click <b>Start</b> .<br><i>Result:</i> The selected test starts.   |

## Overview of the Start Protocol dialog

The following table describes the pages of the Start Protocol.

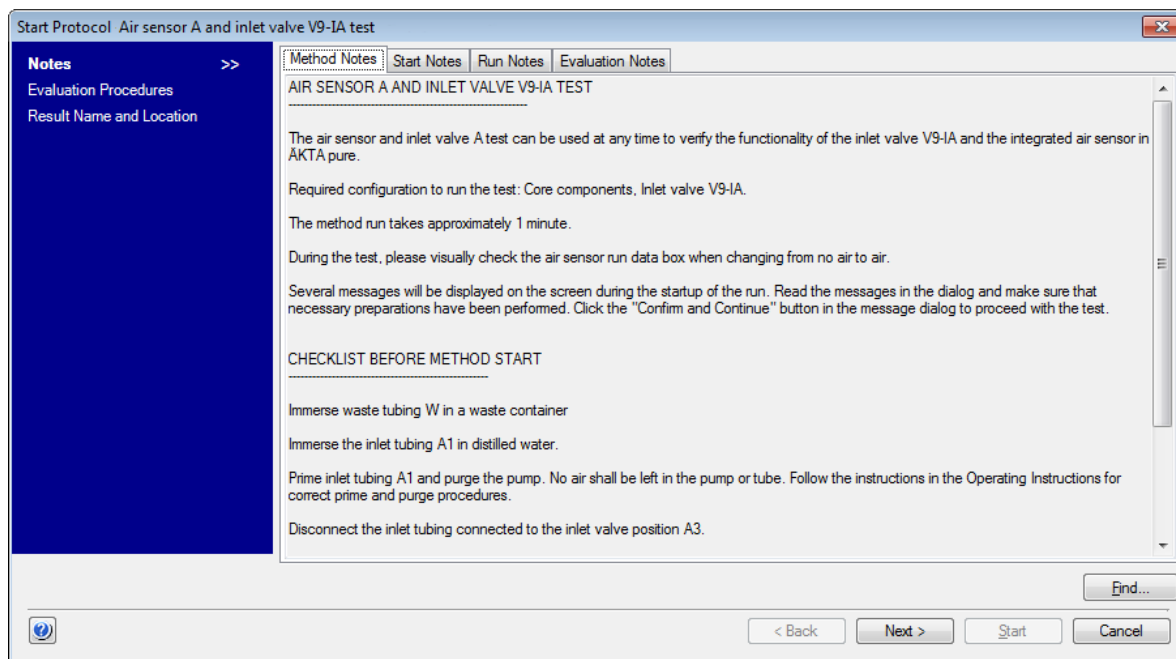

Page	Description
<b>Notes</b>	Displays the <b>Method Notes</b> of the method. The <b>Method Notes</b> contains a method description and instructions on how to run the method. This dialog box also allows the user to enter <b>Start Notes</b> .
<b>Evaluation Procedures</b>	Allows the user to select to save the report to file (recommended) and/or to print the report.
<b>Result Name and Location</b>	Allows the user to change result name and result location.

## During the run

A **Message** dialog box opens during the run. Read the messages in the dialog, and make sure that necessary preparations have been performed.

- Click **Confirm and Continue** in the **Message** dialog box to change system state from **System Pause** to **Run** and proceed with the test.
- Alternatively, click **Confirm** in the **Message** dialog box and click the **Continue** button on the Instrument display.

## Automatic evaluation

The system automatically generates a report when the test is finished. The report can be printed in two ways:

- It is recommended to select **Save the report to file** in the **Evaluation Procedures** page of the **Start Protocol** dialog box when starting the test. The report is saved in the folder `Temp` in your UNICORN installation folder. For example `C:\Program Files\GE Healthcare\UNICORN\UNICORN 7.0\Temp`.
- If the option **Print report** was selected in the **Evaluation Procedures** page of the **Start Protocol** dialog box when starting the test, the report is also automatically printed on the system printer. Refer to UNICORN Administration and Technical Manual for information on how to install a printer.

Print the report and check the status of the tests. For each of the tests the report states "The test passed" OR "The test failed".

**Note:** *The fraction collector test is evaluated manually and no report is generated.*

---

## 6.2 Air sensor A and Inlet valve A tests

### Air sensor A and Inlet valve A tests

The following Air sensor A and Inlet valve A tests are available, for ÄKTA pure 25 and ÄKTA pure 150, respectively:

- **Air sensor A and inlet valve V9-IA test**
  - **Air sensor A and inlet valve V9H-IA test**
- 

### Method description

The Air sensor A and inlet valve A tests switches inlet valve A, labeled **V9-IA** or **V9H-IA**, to an empty position and checks if the air sensor detects air.

The method run takes approximately 1 minute.

---

### Required configuration

A correctly installed Inlet valve A is required to run the test.

---

### Required material

The following materials are required:

- Syringe, 25-30 ml
  - Distilled water
- 

### Prepare the test

Follow the instructions below to prepare the system before method start.

Step	Action
1	Direct the outlet tubing marked <b>W</b> to a waste container.
2	Place inlet tubing <b>A1</b> into distilled water.
3	Prime the <b>A1</b> inlet and purge the pump. See <a href="#">Section 5.4.1 System pumps, on page 161</a> .
4	Disconnect the inlet tubing connected to the <b>A3</b> inlet valve position. During the test method air is introduced into the inlet valve through that inlet port to test the function of the air sensor.

---

## Run and evaluate the test

Follow the instructions described in [Section 6.1 General performance test actions, on page 225](#) to start, run and automatically evaluate the performance test.

---

## Possible causes of a failed test

The tables below describe possible causes of a failed test. When possible sources of error have been checked and corrected, repeat the test.

### Faulty air sensor A test

Cause	Action
Faulty air sensor	For further information, see <a href="#">Section 8.4 Troubleshooting: Valves, on page 375</a> .
Incorrect preparation of tubing	Make sure that the tubing was correctly prepared, see <a href="#">Prepare the test, on page 228</a> .

### Faulty inlet valve A test

Cause	Action
The valve did not switch	For further information, see <a href="#">Section 8.4 Troubleshooting: Valves, on page 375</a> .

## 6.3 Air sensor B and Inlet valve B tests

### Air sensor B and Inlet valve B tests

The following Air sensor B and Inlet valve B tests are available, for ÄKTA pure 25 and ÄKTA pure 150, respectively:

- **Air sensor B and inlet valve V9-IB test**
  - **Air sensor B and inlet valve V9H-IB test**
- 

### Method description

The Air sensor B and inlet valve B test switches the inlet valve B, labeled **V9-IB** or **V9H-IB**, to an empty position and checks if the air sensor detects air.

The method run takes approximately 1 minute.

---

### Required configuration

A correctly installed Inlet valve B is required to run the test.

---

### Required material

The following materials are required:

- Syringe, 25-30 ml
  - Distilled water
- 

### Prepare the test

Follow the instructions below to prepare the system before method start.

Step	Action
1	Direct the outlet tubing marked <b>W</b> to a waste container.
2	Place inlet tubing <b>B1</b> into distilled water.
3	Prime the <b>B1</b> inlet and purge the pump. See <a href="#">Section 5.4.1 System pumps, on page 161</a> .
4	Disconnect the inlet tubing connected to inlet valve position <b>B3</b> . During the test method air is introduced into the inlet valve through that inlet port to test the function of the air sensor.

---

## Run and evaluate the test

Follow the instructions described in [Section 6.1 General performance test actions, on page 225](#) to start, run and automatically evaluate the performance test.

---

## Possible causes of a failed test

The tables below describe possible causes of a failed test. When possible sources of error have been checked and corrected, repeat the test.

### Faulty air sensor B test

Cause	Action
Faulty air sensor	For further information, see <a href="#">Section 8.4 Troubleshooting: Valves, on page 375</a> .
Incorrect preparation of tubing	Make sure that the tubing was correctly prepared, see <a href="#">Prepare the test, on page 230</a> .

### Faulty inlet valve B test

Cause	Action
The valve did not switch	For further information, see <a href="#">Section 8.4 Troubleshooting: Valves, on page 375</a> .

## 6.4 Air sensor S and Sample inlet valve tests

### Air sensor S and Sample inlet valve tests

The following Air sensor S and Sample inlet valve tests are available, for ÄKTA pure 25 and ÄKTA pure 150, respectively:

- **Air sensor S and Sample inlet valve V9-IS test**
- **Air sensor S and Sample inlet valve V9H-IS test**

---

### Method description

The Air sensor S and Sample inlet valve test checks the functionality of the Sample inlet valve, labeled **V9-IS** or **V9H-IS**, and the integrated air sensor in ÄKTA pure.

The method run takes approximately 1 minute.

---

### Required configuration

Core components of the ÄKTA pure and correctly installed Sample Inlet valve and Sample pump are required to run the test.

---

### Required material

The following materials are required:

- Syringe, 25-30 ml
- Distilled water

---

### Prepare the test

Follow the instructions below to prepare the system before method start.

Step	Action
1	Open <b>System Control</b> and update the system setting <b>Tubing: Sample pump to injection valve</b> (found in <b>System Settings:Tubing and Delay volumes</b> ).  <b>Note:</b> <i>The system setting <b>Tubing: Sample pump to injection valve</b> is available only if Column valve C is not included in the system.</i>
2	Immerse waste tubing <b>W</b> in a waste container
3	Immerse sample inlet tubing <b>Buffer</b> in distilled water.
4	Prime inlet tubing <b>A1</b> and sample inlet <b>Buffer</b> and purge the sample pump. See <a href="#">Section 5.4 Prime inlets and purge pump heads, on page 160</a> . No air shall be left in the pumps or tubings.



Step	Action
5	Disconnect the inlet tubing connected to the sample inlet valve position <b>S3</b> . During the test method air is introduced into the sample inlet valve through that inlet port to test the function of the air sensor.

## Run and evaluate the test

Follow the instructions described in [Section 6.1 General performance test actions, on page 225](#) to start, run and automatically evaluate the performance test.

## Possible causes of a failed test

The tables below describe possible causes of a failed test. When possible sources of error have been checked and corrected, repeat the test.

### Faulty air sensor S test

Cause	Action
Faulty air sensor	For further information, see <a href="#">Section 8.4 Troubleshooting: Valves, on page 375</a> .
Incorrect preparation of tubing	Make sure that the tubing was correctly prepared, see <a href="#">Prepare the test, on page 230</a> .

### Faulty Sample inlet valve test

Cause	Action
The valve did not switch	For further information, see <a href="#">Section 8.4 Troubleshooting: Valves, on page 375</a> .

## 6.5 Column valve C tests

### Column valve C tests

The following Column valve C tests are available, for ÄKTA pure 25 and ÄKTA pure 150, respectively:

- **Column valve V9-C test**
- **Column valve V9H-C test**

**Note:** No tests are available for V9-Cs or V9H-Cs.

---

### Method description

The Column valve C test checks the functionality of Column valve C, labeled **V9-C** or **V9H-C**, and of the integrated pressure sensors that measure pre-column and post-column pressure. If two valves are used, the test will check the pre-column pressure sensor in the first valve and the post-column pressure sensor in the second valve.

The method run takes approximately 1 minute.

---

### Required configuration

A correctly installed Column valve C is required to run the test.

---

### Required material

The following materials are required:

- Syringe, 25-30 ml
  - Distilled water
  - **Ref 1** tubing, see [Reference capillary, on page 426](#).
- 

### Prepare the test

Follow the instructions below to prepare the system before method start.

Step	Action
1	Connect the <b>Ref 1</b> tubing between Column valve C ports <b>1A</b> and <b>1B</b> .
2	Make sure the Flow restrictor is inline.
3	Direct outlet tubing <b>W</b> to a waste container.
4	Place inlet tubing <b>A1</b> into distilled water.
5	Prime the inlet <b>A1</b> and purge the pump. See <a href="#">Section 5.4.1 System pumps, on page 161</a> .

---

## Run and evaluate the test

Follow the instructions described in [Section 6.1 General performance test actions, on page 225](#) to start, run and automatically evaluate the performance test.

---

## Possible causes of a failed test

The table below describes possible causes of a failed test. When possible sources of error have been checked and corrected, repeat the test.

Cause	Action
Faulty Column valve	For further information, see <a href="#">Section 8.4 Troubleshooting: Valves, on page 375</a> .
The integrated pressure monitors are not calibrated	Calibrate the pressure monitors, see <a href="#">Section 7.7.2 Calibrate the pressure monitors, on page 305</a> .
Incorrect preparation of the system	Make sure that the reference tubing is connected between column ports <b>1A</b> and <b>1B</b> and that the flow restrictor is in-line.

## 6.6 Fraction collector F9-C test

### Method description

The Fraction Collector Test checks the functionality of **Fraction collector F9-C**.

The method run takes approximately 6 minutes.

---

### Required configuration

The core components of ÄKTA pure, an outlet valve and a correctly installed **Fraction collector F9-C** are required to run the test.

---

### Required material

The following materials are required:

- Distilled water
  - Syringe, 25-30 ml
  - Two deep well cassettes
  - Two 96 deep well plates for collecting the fractions
- 

### Prepare the test

Follow the instructions below to prepare the system before method start.

Step	Action
1	Immerse waste tubing <b>W</b> in a waste container
2	Immerse inlet tubing <b>A1</b> in distilled water.
3	Prime inlet tubing <b>A1</b> and purge System pump A. See <a href="#">Section 5.4.1 System pumps, on page 161</a> . No air shall be left in the pump or tubing.
4	Place two 96 deep well plates in positions 1 and 6 in the fraction collector. Make sure that no other cassettes are present in the fraction collector during the run.
5	In the <b>System Control</b> module, select <b>System:Settings</b> . <i>Result:</i> The <b>System Settings</b> dialog opens.
6	In the <b>System Settings</b> dialog: <ul style="list-style-type: none"><li>• Select <b>Fraction collection:Fractionation settings</b>.</li><li>• In the <b>Fraction mode</b> field, select <b>Automatic</b>.</li><li>• In the <b>Fractionation order</b> field, select <b>Row-Automaticby-Row</b>.</li><li>• Click <b>OK</b>.</li></ul>

Step	Action
7	<p>In the <b>System Settings</b> dialog:</p> <ul style="list-style-type: none"><li>• Select <b>Tubing and Delay volumes</b>.</li><li>• Select the instruction <b>Delay volume: Monitor to frac</b></li><li>• Set the correct delay volume, see <a href="#">Section 9.13 Delay volumes, on page 493</a></li><li>• Click <b>OK</b>.</li></ul>

## Run and evaluate the test

Follow the instructions described in [Section 6.1 General performance test actions, on page 225](#) to start and run the performance test.

## During the run

- Visually check that the fraction collector wash is performed.
- Several messages will be displayed on the screen during the startup of the run. Read the messages in the dialog and make sure that necessary preparations have been performed. Click the "Confirm and Continue" button in the message dialog to proceed with the test.

## Evaluate the result

To evaluate the results, do the following:

- Check that correct volumes, 2 ml/well, are collected in the three first wells in row A (A1-A3) of both plates.
- Check if the fractionation marks in the chromatogram are in accordance with the filled wells. For further information on delay volumes and fractionation marks, see [Delay volume, on page 207](#).

## Possible causes of a failed test

The table below describes possible causes of a failed test. When possible sources of error have been checked and corrected, repeat the test.

Cause	Action
Incorrect volumes collected in the tubes, and disturbances of system pressure curves: <ul style="list-style-type: none"><li>• Air trapped in System pump A</li><li>• Faulty System pump A</li></ul>	Air in pumps: Make sure to prime inlet tubing <b>A1</b> and purge System pump A before method start, see <a href="#">Section 5.4.1 System pumps, on page 161</a> . Faulty pump: See <a href="#">Section 8.6 Troubleshooting: Pumps, on page 387</a> .
Incorrect preparation of buffer and tubing	Make sure that the system was correctly prepared, see <a href="#">Prepare the test, on page 236</a> .

## 6.7 Fraction Collector F9-R Test

### Method description

The Fraction collector F9-R test checks the functionality of **Fraction collector F9-R**.  
The method run takes approximately 3 minutes.

---

### Required configuration

A correctly installed Outlet valve, and a correctly installed **Fraction collector F9-R** are required to run the test.

---

### Required material

The following materials are required:

- Distilled water
  - Syringe, 25-30 ml
  - 7 tubes for collecting the fractions.
- 

### Prepare the test

Follow the instructions below to prepare the system before method start.

Step	Action
1	Direct outlet tubing <b>W</b> to a waste container.
2	Place inlet tubing <b>A1</b> into distilled water.
3	Prime inlet <b>A1</b> and purge System pump A. See <a href="#">Section 5.4.1 System pumps, on page 161</a> .
4	Place 7 tubes in the Fraction collector, in positions 1 to 7.
5	In the <b>System Control</b> module, select <b>System:Settings</b> . <i>Result:</i> The <b>System Settings</b> dialog opens.
6	In the <b>System Settings</b> dialog: <ul style="list-style-type: none"><li>• Select <b>Fraction collector:Fractionation settings</b>.</li><li>• In the <b>Drop sync</b> field, select <b>On</b>.</li><li>• Click <b>OK</b>.</li></ul>

---

### Run and evaluate the test

Follow the instructions described in [Section 6.1 General performance test actions, on page 225](#) to start and run the performance test.

---

## Evaluate the result

Check that the correct volumes have been collected in the tubes. The tubes should contain the following:

- Tube **1**: The delay volume
- Tube **2-4**: 2 ml
- Tube **5-6**: 1 ml

Also, check that the fractionation marks in the chromatogram correspond to the filled tubes and that spillages are kept to a minimum.

For further information on delay volumes and fractionation marks, see [Delay volume, on page 207](#).

## Possible causes of a failed test

The table below describes possible causes of a failed test. When possible sources of error have been checked and corrected, repeat the test.

Cause	Action
Incorrect volumes collected in the tubes, and disturbances of system pressure curves: <ul style="list-style-type: none"><li>• Air trapped in System pump A</li><li>• Faulty System pump A</li></ul>	Air in pumps: Make sure to prime inlet tubing <b>A1</b> and purge System pump A before method start, see <a href="#">Section 5.4.1 System pumps, on page 161</a> . Faulty pump: See <a href="#">Section 8.6 Troubleshooting: Pumps, on page 387</a> .
Liquid collected in wrong tubes:	Make sure the fraction collector delivery arm is positioned above tube number 1 before starting the test.
Incorrect preparation of buffer and tubing	Make sure that the system was correctly prepared, see <a href="#">Prepare the test, on page 239</a> .



## 6.8 Sample pump tests

### Sample pumps tests

The following Sample pump tests are available, for ÄKTA pure 25 and ÄKTA pure 150, respectively:

- **Sample pump S9 test**
  - **Sample pump S9H test**
- 

### Method description

The Sample Pump test checks the functionality of the sample pump, labeled **S9** or **S9H**.

The method run takes approximately 12 minutes.

---

### Required configuration

The core components of ÄKTA pure and a correctly installed Sample pump are required to run the test.

---

### Required material

The following materials are required:

- Distilled water
  - 1% Acetone and 1.00 M NaCl in distilled water
  - Syringe, 25-30 ml
  - **Ref 1** tubing, see [Reference capillary, on page 426](#).
- 

### Prepare the test

Follow the instructions below to prepare the system before method start.

Step	Action
1	Connect a tubing between Injection valve port column and the UV inlet, preferably the <b>Ref 1</b> tubing included with the system at delivery.
2	Immerse waste tubing W, W1 and W2 in a waste container.
3	Immerse inlet tubing <b>A1</b> in distilled water.
4	Immerse sample inlet tubing <b>Buffer</b> in 1% Acetone and 1.00 M NaCl in distilled water.
5	Prime inlet tubing <b>A1</b> and sample inlet <b>Buffer</b> and purge the pumps. See <a href="#">Section 5.4.2 Sample pump, on page 167</a> and. No air shall be left in the pumps or tubings.

---

## Run and evaluate the test

Follow the instructions described in [Section 6.1 General performance test actions, on page 225](#) to start, run and automatically evaluate the performance test.

## Possible causes of a failed test

The table below describes possible causes of a failed test. When possible sources of error have been checked and corrected, repeat the test.

Cause	Action
<p>The two injected peaks of liquid are not delivered as proportional peaks:</p> <ul style="list-style-type: none"> <li>Air trapped in Sample pump</li> <li>Faulty Sample pump</li> </ul>	<p>Air in pump: Make sure to prime inlet tubing <b>Buffer</b> and purge sample pump before method start, see <a href="#">Section 5.4.2 Sample pump, on page 167</a>.</p> <p>Faulty pump: See <a href="#">Section 8.6 Troubleshooting: Pumps, on page 387</a>.</p>
<p>The delivery of liquid is pulsating (unstable pump pressure)</p>	<p>Air in pump: Make sure to prime inlet tubing <b>Buffer</b> and purge sample pump before method start, see <a href="#">Section 5.4.2 Sample pump, on page 167</a>.</p> <p>Faulty pump: See <a href="#">Section 8.6 Troubleshooting: Pumps, on page 387</a>.</p>
<p>The pump pressure is too high (at a flow rate of 25 ml/min or 150 ml/min for ÄKTA pure 25 and ÄKTA pure 150, respectively)</p>	<p>Folded, twisted or blocked tubing: Check the tubing.</p> <p>The Sample pump pressure monitor is not calibrated: Calibrate the pressure monitor, see <a href="#">Section 7.7.2 Calibrate the pressure monitors, on page 305</a>.</p> <p>Faulty pump: See <a href="#">Section 8.6 Troubleshooting: Pumps, on page 387</a>.</p>
<p>Incorrect preparation of buffer and tubing</p>	<p>Make sure that the system was correctly prepared, see <a href="#">Prepare the test, on page 241</a>.</p>

## 6.9 System Test UV U9-L (fixed)

### Method description

The System test with UV monitor **U9-L** checks the functionality of the solvent delivery, the pumps, the System pump pressure sensor, UV monitor **U9-L** and the Conductivity monitor.

The method run takes approximately 35 minutes.

---

### Required configuration

A correctly installed UV monitor **U9-L** and a correctly installed Conductivity monitor are required to run the test.

---

### Required material

The following materials are required:

- Distilled water
  - 1% acetone and 1.00 M NaCl in distilled water
  - **Ref 1** tubing, see [Reference capillary, on page 426](#).
  - Syringe, 25-30 ml
  - Mixer, 1.4 ml
- 

### Prepare the test

Follow the instructions below to prepare the system before method start.

Step	Action
1	Direct outlet tubing <b>W</b> and <b>W1</b> to a waste container.
2	Place inlet tubing <b>A1</b> into distilled water.
3	Place inlet tubing <b>B1</b> into a solution of 1% acetone and 1.00 M NaCl in distilled water.
4	Connect the <b>Ref 1</b> tubing between Injection valve port <b>Col</b> and the UV monitor <b>U9-L</b> inlet, to generate a back pressure.
5	Make sure that the Mixer with a chamber volume of 1.4 ml is installed. For further information, see <a href="#">Section 7.8.3 Replace the Mixer, on page 322</a> .
6	Prime the buffer inlets and purge System pump A and System pump B. See <a href="#">Section 5.4.1 System pumps, on page 161</a> .

---

**Note:** *If the test is performed at cold room temperature, select **Conductivity:Cond temp compensation** in the **System Settings** dialog, and set the **Compensation factor** to 2.1.*

## Run and evaluate the test

Follow the instructions described in [Section 6.1 General performance test actions, on page 225](#) to start, run and automatically evaluate the performance test.

## Illustration of chromatogram

The illustration below shows a chromatogram from a System test with UV monitor **U9-L**.

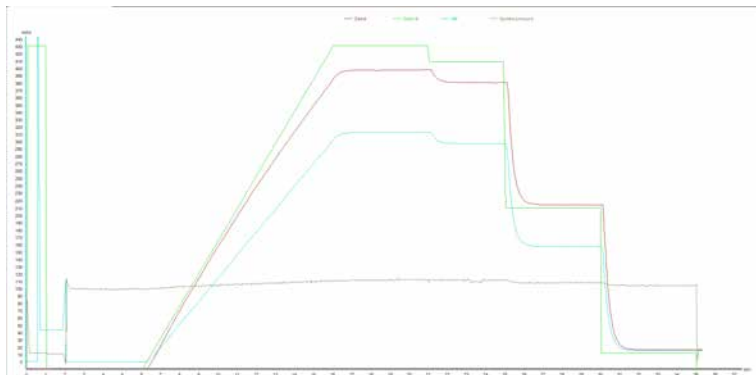

## Possible causes of a failed test

The following tables describe possible causes of a failed test. When possible sources of error have been checked and corrected, repeat the test.

### Faulty Gradient Test Result

Cause	Action
Disturbances caused by air trapped in any of the pumps	Make sure to prime the buffer inlets and to purge the System pumps before method start. See <a href="#">Section 5.4.1 System pumps, on page 161</a> .
Disturbances caused by damaged pump piston seals	Replace piston seals. See <a href="#">Chapter 7 Maintenance, on page 251</a> .
Unstable or incorrect UV signal, or drifting base line: <ul style="list-style-type: none"><li>Faulty UV monitor</li></ul>	See <a href="#">Section 8.3 Troubleshooting: Monitors, on page 360</a> .
Wrong Mixer chamber size or faulty Mixer	Replace the Mixer. See <a href="#">Chapter 7 Maintenance, on page 251</a> .

## Faulty Step Response Result

Cause	Action
If all values are faulty: <ul style="list-style-type: none"> <li>Air in the pump or a faulty pump</li> </ul>	Air in pumps: Make sure to prime the buffer inlets and to purge the System pumps before method start. See <a href="#">Section 5.4.1 System pumps, on page 161</a> . Faulty pump: See <a href="#">Chapter 7 Maintenance, on page 251</a> .
Faulty values at 5%: <ul style="list-style-type: none"> <li>Damaged pump piston seal in System pump B</li> </ul>	Replace piston seals. See <a href="#">Chapter 7 Maintenance, on page 251</a> .
Faulty values at 95%: <ul style="list-style-type: none"> <li>Damaged pump piston seal in System pump A</li> </ul>	Replace piston seals. See <a href="#">Chapter 7 Maintenance, on page 251</a> .

## Faulty UV Absorbance Test

Cause	Action
Incorrectly prepared acetone solution	Make sure that the acetone solution is 1% and that no solution has evaporated.
Wrong UV cell path length set in UNICORN	See, <a href="#">Calibration of the UV monitor U9-L flow cell length, on page 312</a> .

## Faulty Pulsation Test

Cause	Action
Air trapped in the pumps	Make sure to prime and purge the system pumps before starting the test, see <a href="#">Section 5.4.1 System pumps, on page 161</a> .

## Faulty Conductivity Test Result

Cause	Action
Faulty Conductivity monitor	See <a href="#">Conductivity monitor, on page 367</a> .
Incorrectly prepared NaCl solution	Make sure the NaCl solution is 1.00 M.
The value set for the Cond temp compensation factor is not optimal	If the test is performed at cold room temperature, open the <b>System Settings</b> dialog, select <b>Conductivity:Cond temp compensation</b> and set the <b>Compensation factor</b> to 2.1

## Faulty UV Noise Test

Cause	Action
Air or dirt in the UV flow cell	Flush or clean the UV cell, see <a href="#">Section 7.5.1 Clean the UV flow cell, on page 273</a> .
Impure buffers	Check the buffers.

## Faulty Pressure Check Test

Cause	Action
Folded, twisted or blocked tubing	Check the tubing.
The inline filter is dirty	Replace the inline filter, see <a href="#">Section 7.3.2 Replace the inline filter, on page 266</a> .
The System pressure monitor is not calibrated	Calibrate the pressure monitor, see <a href="#">Section 7.7.2 Calibrate the pressure monitors, on page 305</a> .

## 6.10 System Test UV U9-M (variable)

### Method description

The System test with UV monitor **U9-M** checks the functionality of the solvent delivery, the pumps, the System pump pressure sensor, UV monitor **U9-M** and the Conductivity monitor.

The method run takes approximately 35 minutes.

---

### Required configuration

A correctly installed UV monitor **U9-M** and a correctly installed Conductivity monitor are required to run the test.

---

### Required material

The following materials are required:

- Distilled water
  - 1% acetone and 1.00 M NaCl in distilled water
  - **Ref 1** tubing, see [Reference capillary, on page 426](#).
  - Syringe, 25-30 ml
  - Mixer, 1.4 ml
- 

### Prepare the test

Follow the instructions below to prepare the system before method start.

Step	Action
1	Direct outlet tubing <b>W</b> and <b>W1</b> to a waste container.
2	Place inlet tubing <b>A1</b> into distilled water.
3	Place inlet tubing <b>B1</b> into a solution of 1% acetone and 1.00 M NaCl in distilled water.
4	Connect the <b>Ref 1</b> tubing between Injection valve port <b>Col</b> and the UV monitor <b>U9-M</b> inlet, to generate a back pressure.
5	Make sure that the Mixer with a chamber volume of 1.4 ml is installed. For further information, see <a href="#">Section 7.8.3 Replace the Mixer, on page 322</a> .
6	Prime the buffer inlets and purge System pump A and System pump B. See <a href="#">Section 5.4.1 System pumps, on page 161</a> .

---

**Note:** *If the test is performed at cold room temperature, select **Conductivity:Cond temp compensation** in the **System Settings** dialog, and set the **Compensation factor** to 2.1.*

## Run and evaluate the test

Follow the instructions described in [Section 6.1 General performance test actions, on page 225](#) to start, run and automatically evaluate the performance test.

## Illustration of chromatogram

The illustration below shows a chromatogram from a System test with UV monitor **U9-M**.

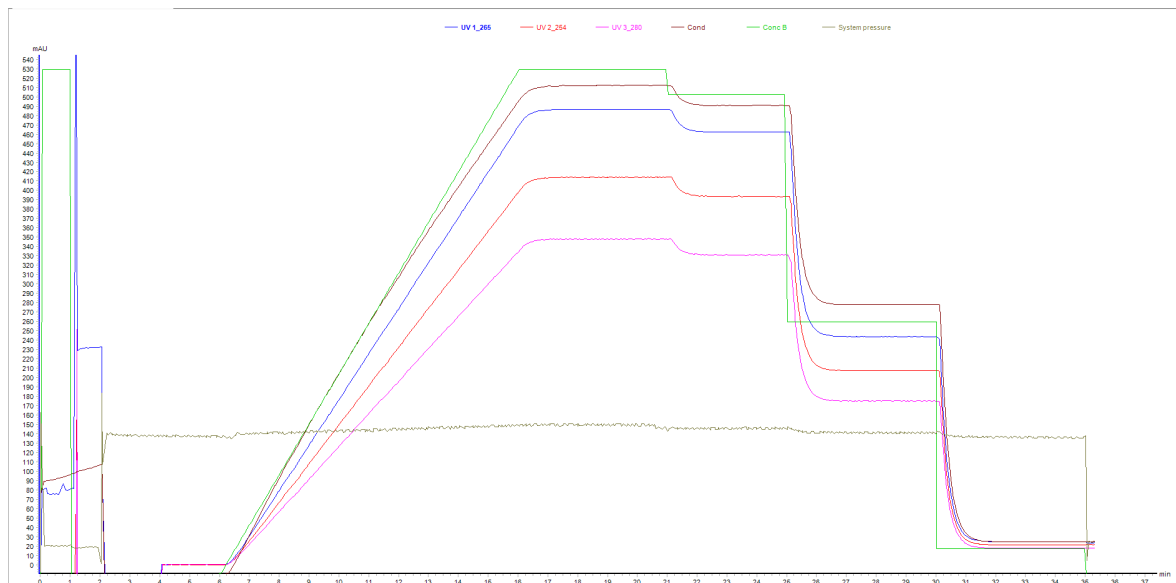

## Possible causes of a failed test

The following tables describe possible causes of a failed test. When possible sources of error have been checked and corrected, repeat the test.

### Faulty Gradient Test Result

Cause	Action
Disturbances caused by air trapped in any of the pumps	Make sure to prime the buffer inlets and to purge the System pumps before method start. See <a href="#">Section 5.4.1 System pumps, on page 161</a> .
Disturbances caused by damaged pump piston seals	Replace piston seals. See <a href="#">Chapter 7 Maintenance, on page 251</a> .
Unstable or incorrect UV signal, or drifting base line: <ul style="list-style-type: none"> <li>Faulty UV monitor</li> </ul>	See <a href="#">Section 8.3 Troubleshooting: Monitors, on page 360</a> .
Wrong Mixer chamber size or faulty Mixer	Replace the Mixer. See <a href="#">Chapter 7 Maintenance, on page 251</a> .



## Faulty Step Response Result

Cause	Action
If all values are faulty: <ul style="list-style-type: none"> <li>Air in the pump or a faulty pump</li> </ul>	Air in pumps: Make sure to prime the buffer inlets and to purge the System pumps before method start. See <a href="#">Section 5.4.1 System pumps, on page 161</a> . Faulty pump: See <a href="#">Chapter 7 Maintenance, on page 251</a>
Faulty values at 5%: <ul style="list-style-type: none"> <li>Damaged pump piston seal in System pump B</li> </ul>	Replace piston seals. See <a href="#">Chapter 7 Maintenance, on page 251</a> .
Faulty values at 95%: <ul style="list-style-type: none"> <li>Damaged pump piston seal in System pump A</li> </ul>	Replace piston seals. See <a href="#">Chapter 7 Maintenance, on page 251</a> .

## Faulty UV Response Test Result

Cause	Action
Faulty UV monitor	Restart the instrument to calibrate the UV monitor. See <a href="#">Section 8.3 Troubleshooting: Monitors, on page 360</a> .

## Faulty UV Absorbance Test

Cause	Action
Incorrectly prepared acetone solution	Make sure that the acetone solution is 1% and that no solution has evaporated.

## Faulty Pulsation Test

Cause	Action
Air trapped in the pumps	Make sure to prime and purge the system pumps before starting the test, see <a href="#">Section 5.4.1 System pumps, on page 161</a> .

## Faulty Conductivity Test Result

Cause	Action
Faulty Conductivity monitor	See <a href="#">Conductivity monitor, on page 367</a> .
Incorrectly prepared NaCl solution	Make sure that the NaCl solution is 1.00 M.
The value set for the Cond temp compensation factor is not optimal	If the test is performed at cold room temperature, open the <b>System Settings</b> dialog, select <b>Conductivity:Cond temp compensation</b> and set the <b>Compensation factor</b> to 2.1

## Faulty UV Noise Test

Cause	Action
Air or dirt in the UV flow cell	Flush or clean the UV cell, see <a href="#">Section 7.5.1 Clean the UV flow cell, on page 273</a> .
Impure buffer	Check buffers for impurities.

## Faulty Pressure Check Test

Cause	Action
Folded, twisted or blocked tubing	Check the tubing.
Dirt in inline filter	Replace the inline filter, see <a href="#">Section 7.3.2 Replace the inline filter, on page 266</a> .
System pressure monitor not calibrated	Calibrate the pressure monitor, see <a href="#">Section 7.7.2 Calibrate the pressure monitors, on page 305</a> .

# 7 Maintenance

## About this chapter

This chapter describes the maintenance program for ÄKTA pure and provides instructions for maintenance and replacement of spare parts.

---

## In this chapter

This chapter contains the following sections:

Section	See page
7.1 Maintenance Manager	252
7.2 Maintenance program	258
7.3 Weekly maintenance	261
7.4 Monthly maintenance	269
7.5 Semiannual maintenance	272
7.6 Maintenance when required	276
7.7 Calibration procedures	302
7.8 Replacement procedures	316

---

## 7.1 Maintenance Manager

### Introduction

**Maintenance Manager** allows the user to display general information about the system and its modules, and also operational statistics of the modules. Notifications for maintenance actions of the system and its modules are predefined. The user can add automated maintenance notifications for the system. Maintenance notifications are based on calendar periods of system use, and for some systems also on operational statistics for the modules.

### Open Maintenance Manager

In the **System Control** module, on the **System** menu, click **Maintenance Manager** to open the **Maintenance Manager** dialog box.

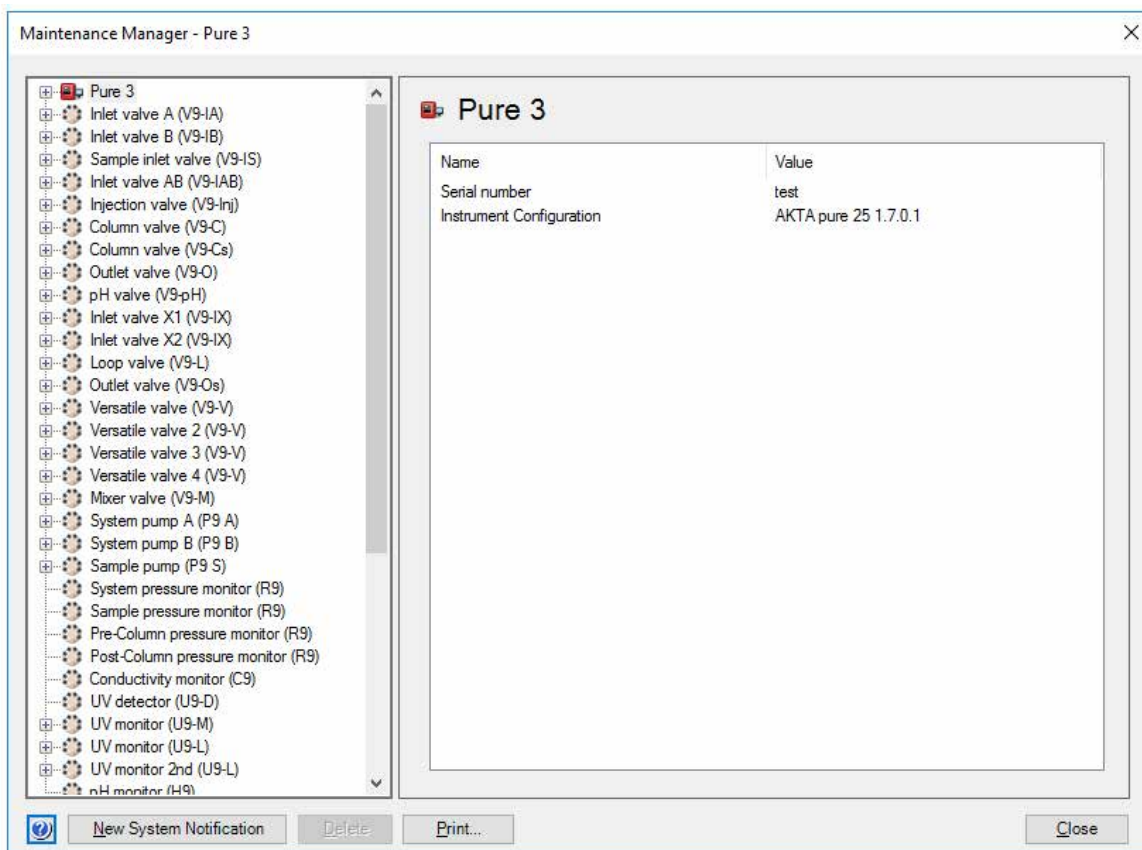

## View general information and statistics

In the left pane of the **Maintenance Manager** dialog box, select the system of interest to view general information of the selected system. For some systems it is possible to view information for a module of interest. When modules are selected, operational statistics are also displayed.

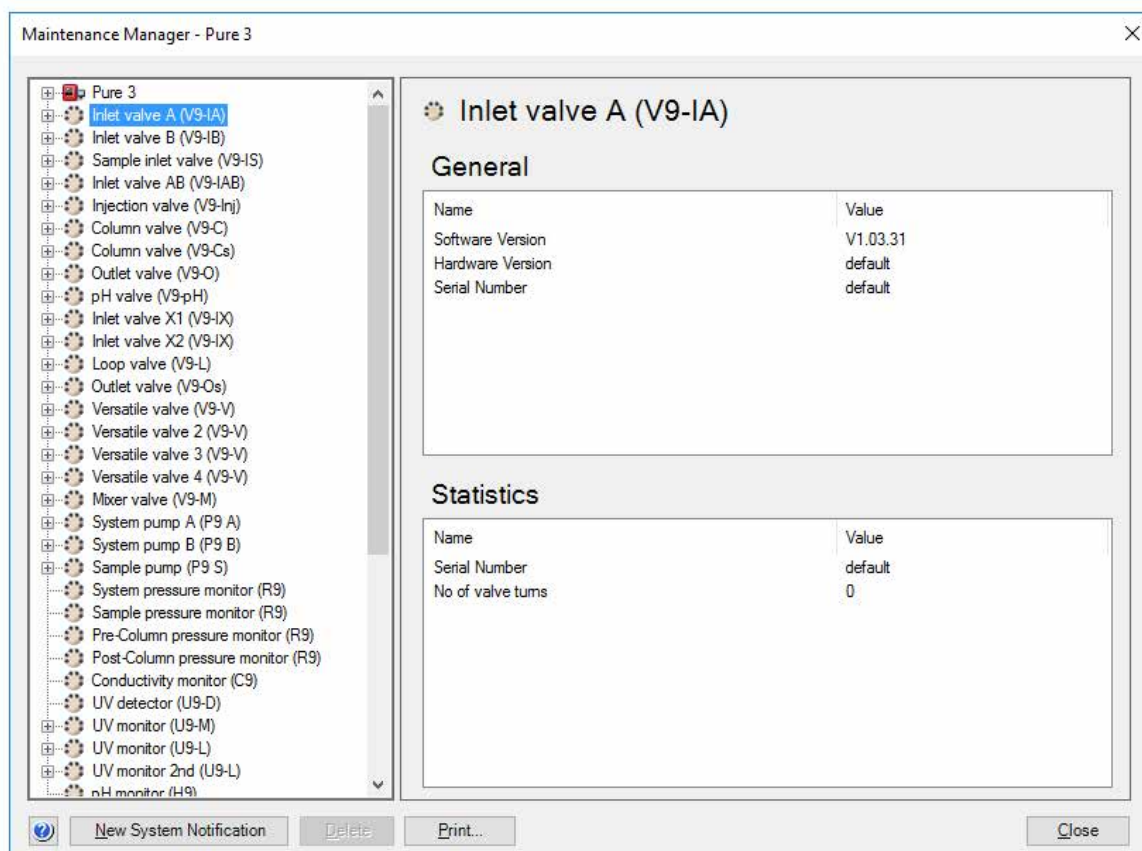

## View maintenance notifications

Click the plus symbol (+) of the system of interest to expand the list of related maintenance notifications. For some systems it is possible to view maintenance notifications for a module of interest. Select a notification to view notification details.

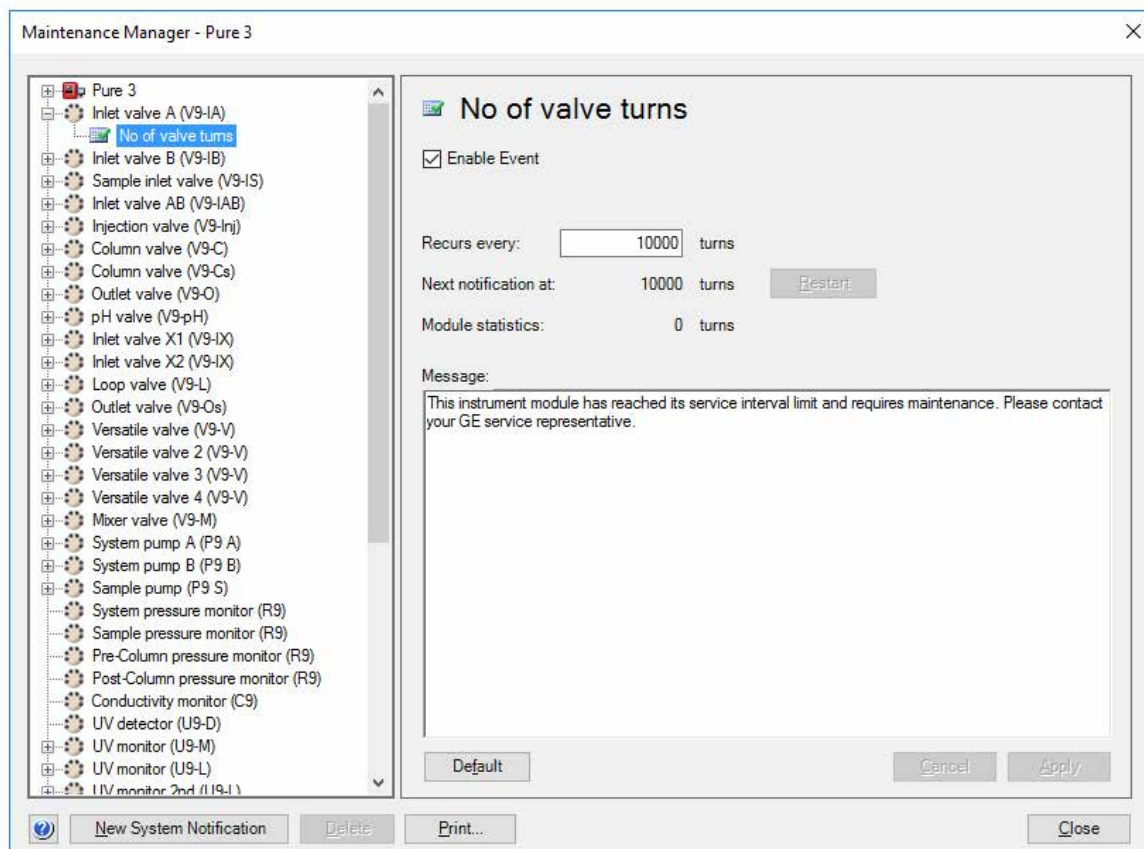

**Note:** Modules with no plus symbol (+) have no related maintenance notifications.

## Edit a maintenance notification

Follow the instruction to edit a maintenance notification.

Step	Action
------	--------

- |   |   |
|---|---|
| 1 | In the left pane of the <b>Maintenance Manager</b> dialog box, select a maintenance notification.<br><i>Result:</i> Details of the selected maintenance notification are displayed in the dialog box. |
|---|---|

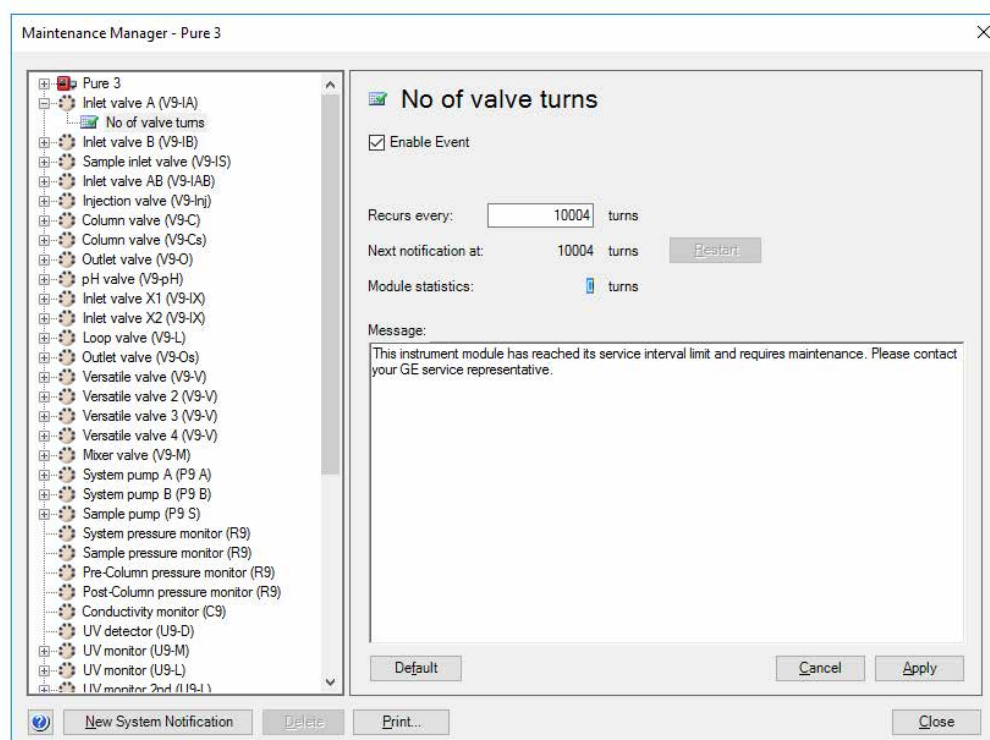

- |   |  |
|---|--|
| 2 | Edit the maintenance notification as desired: <ul style="list-style-type: none"><li>• Select the <b>Enable Event</b> check box to activate the notification. If the box is unchecked, the notification is not issued.</li><li>• Enter a new interval after which the new notification is issued.</li><li>• Click <b>Restart</b> to reset the counter and add a complete interval before the next notification.</li><li>• Edit the message that is shown in the maintenance notification.</li><li>• Click <b>Default</b> to restore the default settings for maintenance notifications.</li></ul> |
| 3 | Click <b>Apply</b> to save the changes.  |

## Add a new system notification

The user can add new system notifications to the list of system events.

Follow the instructions to add a new system notification.

**Step**      **Action**

- 1 In the **Maintenance Manager** dialog box, click **New System Notification**.  
*Result:* The **NewNotification** field appears in the **Maintenance Manager** dialog box.

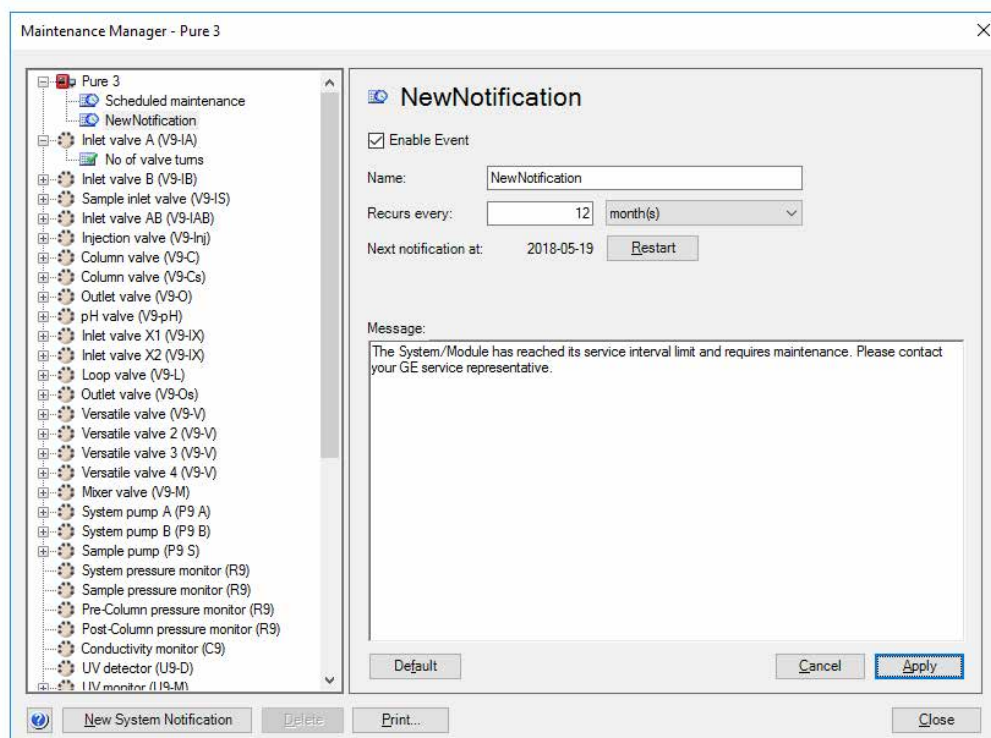

- 2 In the **NewNotification** field:
  - Enter a name for the new notification.
  - Select a time interval after which the new notification is issued.
  - If desired, write a message that is shown for the maintenance notification.
- 3 Click **Apply** to save the changes and apply the notification settings.

## Delete a user defined system notification

To delete a user defined system notification, select the notification in the **Maintenance Manager** dialog box and press the **Delete** button.

**Note:** *Module notifications are predefined and cannot be deleted. If desired, they can be disabled.*



## Handle a maintenance notification

Each maintenance notification has a time interval after which the notification is issued. When this time interval has been reached, a **Maintenance Notification** dialog box appears.

**Note:** *The possibility to add maintenance notifications for modules is only available for some systems, but all systems can add maintenance notifications for the complete system.*

Follow the instruction to handle the notification.

Click...	to...
<b>Acknowledge</b>	reset the counter for a new maintenance notification period.  <b>Note:</b> <i>Make sure that the maintenance action is performed as instructed after the notification is acknowledged, otherwise the system performance can deteriorate.</i>
<b>Ignore</b>	close the dialog box without action.  <b>Note:</b> <i>The <b>Maintenance Notification</b> is displayed each time the <b>System Control</b> module is opened until the notification is acknowledged.</i>

**Note:** *The predefined maintenance notification periods use average values. The actual service interval for a specific module can be shorter or longer.*

## 7.2 Maintenance program

### Introduction

This section lists the periodic maintenance activities that should be performed by the user of ÄKTA pure, as well as maintenance activities that should be performed when required.

Maintenance is divided into:

- Daily maintenance
- Weekly maintenance
- Monthly maintenance
- Semiannual maintenance
- Maintenance when required



#### WARNING

**Hazardous biological agents during run.** When using hazardous biological agents, run **System CIP** and **Column CIP** to flush the entire system tubing with bacteriostatic solution (e.g., NaOH) followed by a neutral buffer and finally distilled water, before service and maintenance.



#### CAUTION

**Hazardous chemicals during run.** When using hazardous chemicals, run **System CIP** and **Column CIP** to flush the entire system tubing with distilled water, before service and maintenance.



#### CAUTION

Always use appropriate personal protective equipment when decommissioning the equipment.

### Periodic maintenance program

The following periodic maintenance should be performed by the user of ÄKTA pure.

Interval	Maintenance action	See section
Daily	Calibrate the pH monitor	<a href="#">Section 7.7.1 Calibrate the pH monitor, on page 303</a>
Weekly	Calibrate pressure monitors	<a href="#">Section 7.7.2 Calibrate the pressure monitors, on page 305</a>

Interval	Maintenance action	See section
Weekly	Change pump rinsing solution	<a href="#">Section 7.3.1 Change pump rinsing solution, on page 262</a>
Weekly	Clean fraction collector diodes	<a href="#">Section 7.3.3 Clean the Fraction collector F9-C sensors, on page 267</a>
Monthly	Check the Flow restrictor	Check flow restrictor
Semiannually	Clean the UV flow cell	<a href="#">Section 7.5.1 Clean the UV flow cell, on page 273</a>
Semiannually	Replace pH electrode	<a href="#">Section 7.5.2 Replace the pH electrode, on page 275</a>

## Maintenance when required

The following maintenance should be performed by the user of ÄKTA pure when required.

Maintenance action	See section
Clean the instrument externally	<a href="#">Section 7.6.1 Clean the instrument externally, on page 277</a>
Perform System CIP	<a href="#">Section 7.6.2 Perform System CIP, on page 278</a>
Perform Column CIP	<a href="#">Section 7.6.3 Perform Column CIP, on page 284</a>
Clean Fraction collector F9-C	<a href="#">Section 7.6.4 Clean Fraction collector F9-C, on page 288</a>
Clean Fraction collector F9-R	<a href="#">Section 7.6.5 Clean Fraction collector F9-R, on page 290</a>
Replace tubing and connectors	<a href="#">Section 7.8.1 Replace tubing and connectors, on page 317</a>
Storage of pH electrode	<a href="#">Section 7.6.6 Storage of the pH electrode, on page 291</a>
Clean the pH electrode	<a href="#">Section 7.6.7 Clean the pH electrode, on page 293</a>
Clean the Conductivity flow cell	<a href="#">Section 7.6.10 Clean the Conductivity flow cell, on page 300</a>
Calibrate the Conductivity monitor	<a href="#">Section 7.7.3 Calibrate the Conductivity monitor, on page 308</a>
Calibrate the UV monitor	<a href="#">Section 7.7.4 Calibrate the UV monitors, on page 312</a>
Replace Mixer	<a href="#">Section 7.8.3 Replace the Mixer, on page 322</a>
Replace inline filter	<a href="#">Section 7.3.2 Replace the inline filter, on page 266</a>
Replace O-ring in Mixer	<a href="#">Section 7.8.4 Replace the O-ring inside the Mixer, on page 323</a>

Maintenance action	See section
Replace UV flow cell	<a href="#">Section 7.8.5 Replace the UV monitor U9-M flow cell, on page 325</a> and <a href="#">Section 7.8.6 Replace the UV monitor U9-L flow cell, on page 328</a>
Replace the Flow restrictor	<a href="#">Section 7.8.7 Replace Flow restrictor, on page 330</a>
Replace inlet filters	<a href="#">Section 7.8.8 Replace the inlet filters, on page 331</a>
Wipe off excess oil from the pump head	<a href="#">Section 7.6.9 Wipe off excess oil from the pump head, on page 299</a>
Clean the check valves	<a href="#">Section 7.6.8 Clean the pump head check valves, on page 296</a>
Replace check valves	<a href="#">Section 7.8.9 Replace the pump head check valves, on page 332</a>
Replace pump piston seals, pump P9 and P9H	<a href="#">Section 7.8.10 Replace pump piston seals of Pump P9 or P9H, on page 335</a>
Replace pump piston seals, pump P9-S	<a href="#">Section 7.8.11 Replace pump piston seals of Pump P9-S, on page 344</a>
Replace pump pistons	<a href="#">Section 7.8.12 Replace pump pistons, on page 351</a>
Replace pump rinsing system tubing	<a href="#">Section 7.8.13 Replace pump rinsing system tubing, on page 352</a>

## 7.3 Weekly maintenance

### Introduction

This section provides instructions for weekly maintenance activities.

---

### In this section

This section contains the following subsections:

Section	See page
7.3.1 Change pump rinsing solution	262
7.3.2 Replace the inline filter	266
7.3.3 Clean the Fraction collector F9-C sensors	267

---

## 7.3.1 Change pump rinsing solution

### Maintenance interval

Replace the pump rinsing solution in the system pumps and the sample pump (optional module) every week to prevent bacterial growth.

### Required material

The following material are required:

- 20% ethanol
- Syringe, 25-30 ml

### Illustration of the system pump piston rinsing system

The illustrations below show the parts and tubing of the system pump piston rinsing system

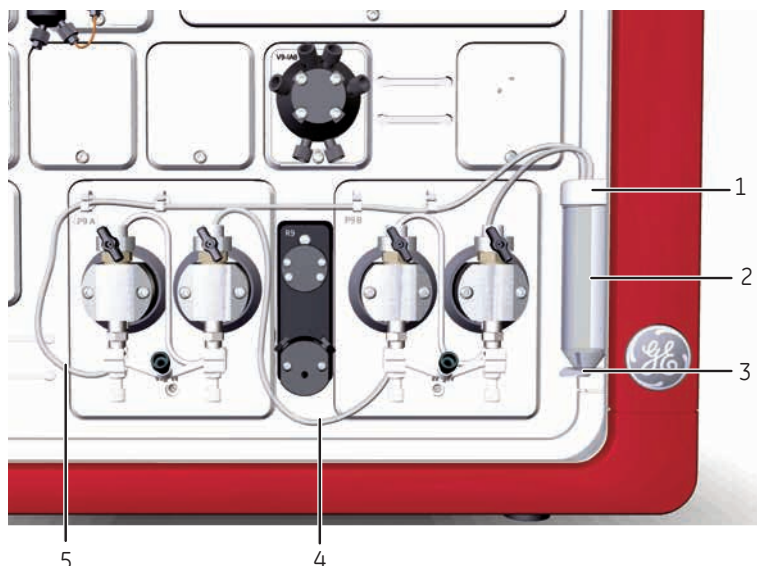

Part	Description
1	Rinsing system tube holder, top
2	Rinsing system tube
3	Rinsing system tube holder, bottom
4	Outlet tubing
5	Inlet tubing

## Prime the system pump piston rinsing system

Follow the instructions below to fill the pump piston rinsing system with rinsing solution. See the tubing configuration of the rinsing system in the illustration above.

Step	Action
------	--------

- |   |   |
|---|---|
| 1 | Remove the rinsing system tube from the holder. |
|---|---|

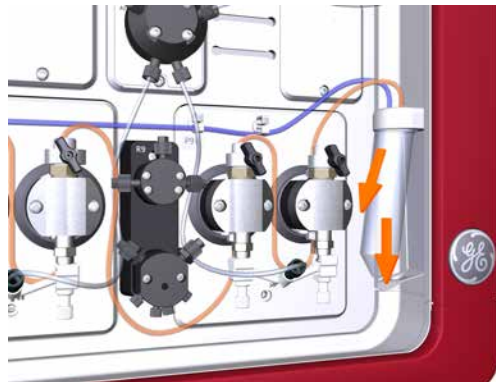

- |   |   |
|---|---|
| 2 | Fill the rinsing system tube with 50 ml of 20% ethanol.   |
| 3 | Place the rinsing solution tube back in the holder.   |
| 4 | Insert the inlet tubing to the System pump piston rinsing system into the fluid in the rinsing solution tube. |

**Note:**

*Make sure that the inlet tubing reaches close to the bottom of the rinsing solution tube.*

- |   |   |
|---|---|
| 5 | Connect a 25 to 30 ml syringe to the outlet tubing of the System pump piston rinsing system. Draw liquid slowly into the syringe. |
|---|---|



- |   |  |
|---|--|
| 6 | Disconnect the syringe and discard its contents.                               |
| 7 | Insert the outlet tubing into the fluid in the rinsing solution tube.          |
| 8 | Fill the rinsing solution tube so that the tube contains 50 ml of 20% ethanol. |

## Illustrations of the sample pump piston rinsing system

The illustrations below show the parts, tubing and flow path of the sample pump piston rinsing system.

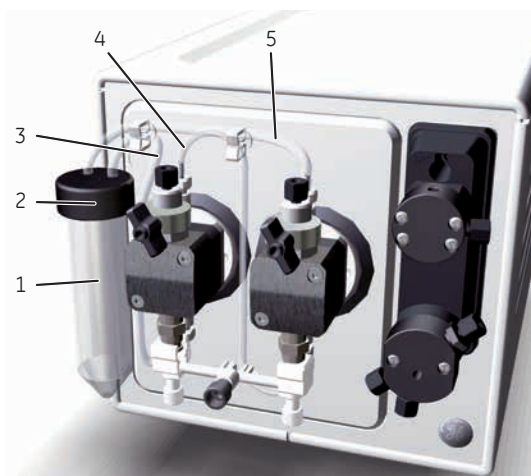

Parts and tubing

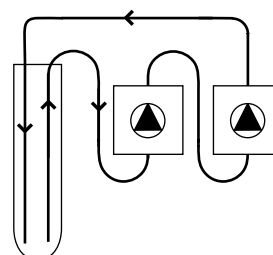

Rinsing system flow path

Part	Function
1	Pump rinsing liquid tube
2	Pump rinsing liquid tube holder
3	Inlet tubing, from the rinsing liquid tube to the left pump head (lower rinsing system connection) .
4	Tubing between the left pump head (upper rinsing system connection) and the right pump head (lower rinsing system connection).
5	Outlet tubing, from the right pump head (upper rinsing system connection) to the rinsing liquid tube.



## Prime the sample pump piston rinsing system

Follow the instructions below to fill the pump piston rinsing system with rinsing solution. For the tubing configuration of the rinsing system, see the illustration above.

Step	Action
------	--------

- |   |   |
|---|---|
| 1 | Unscrew and remove the rinsing liquid tube from the holder. |
|---|---|

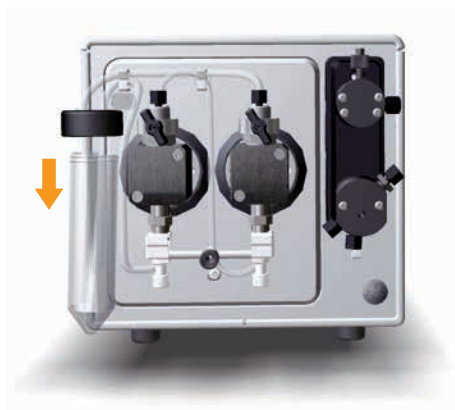

- |   |   |
|---|---|
| 2 | Fill the rinsing liquid tube with 50 ml of 20% ethanol.   |
| 3 | Put the rinsing liquid tube back in the holder and fasten it by screwing it into place.         |
| 4 | Insert the inlet tubing to the piston rinsing system into the fluid in the rinsing liquid tube. |

**Note:**

*Make sure that the inlet tubing reaches close to the bottom of the rinsing liquid tube.*

- |   |   |
|---|---|
| 5 | Connect a 25 to 30 ml syringe to the outlet tubing of the System pump piston rinsing system. Draw liquid slowly into the syringe. |
|---|---|



**Note:**

*The outlet tubing is colored orange for clarity in the above illustration.*

- |   |  |
|---|--|
| 6 | Disconnect the syringe and discard its contents.                             |
| 7 | Insert the outlet tubing into the fluid in the rinsing liquid tube.          |
| 8 | Fill the rinsing liquid tube so that the tube contains 50 ml of 20% ethanol. |

## 7.3.2 Replace the inline filter

### Maintenance interval

Replace the inline filter that is located in the top section of the Mixer every week, or when required, for example when the filter becomes clogged.

---

### Required material

The following materials are required:

- Online filter kit
  - Forceps
  - Gloves
- 

### Instruction

Follow the instructions below to replace the inline filter that is located in the top of the Mixer.

**Tip:** Use forceps and gloves during the replacement procedure to avoid contaminating the Mixer components.

Step	Action
1	Unscrew the top section of the Mixer.
2	Remove the old filter using forceps. Replace the support net if this is damaged. Fit the new filter.



3	Check the O-ring of the Mixer. If the O-ring is damaged, replace it according to <a href="#">Section 7.8.4 Replace the O-ring inside the Mixer, on page 323</a> .
4	While holding the Mixer upright, screw the top section back onto the Mixer.

---

## 7.3.3 Clean the Fraction collector F9-C sensors

### Maintenance interval

Clean the fraction collector sensors every week, or when required, for example if the fraction collector fails to read the tray ID or do not collect fractions correctly.

### Required material

The following material is required:

- Wash bottle
- Water or 20% ethanol
- Cloth

### Instructions

Follow the instructions below to clean the fraction collector diodes. See [Section 3.2.2 Fraction collector F9-C illustrations, on page 92](#) for the locations of the components of the fraction collector.

Step	Action
1	In <b>System Control</b> , select <b>Manual:Execute Manual Instructions:Fraction collection:Frac cleaning position</b> . Click <b>Execute</b> .

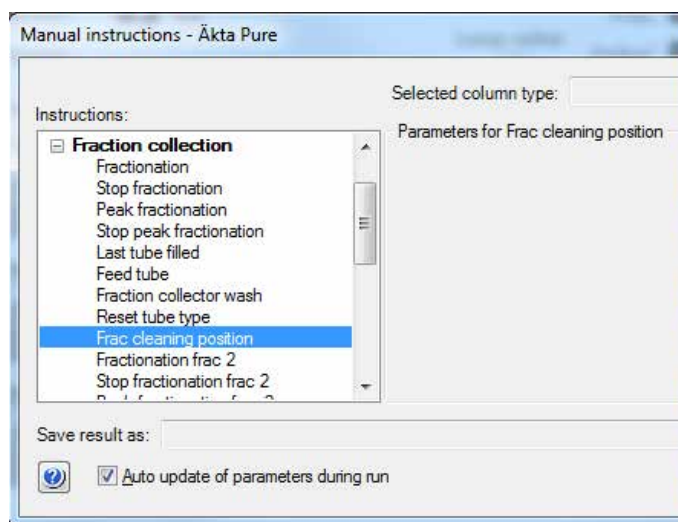

**Result:** The Dispenser head moves to cleaning position, and the Instrument display states **System pause**.

## 7 Maintenance

### 7.3 Weekly maintenance

#### 7.3.3 Clean the Fraction collector F9-C sensors

Step	Action
2	Wipe off the Dispenser head and the Drop sync and Type code reader sensor windows using a wash bottle with water or 20% ethanol and a cloth.

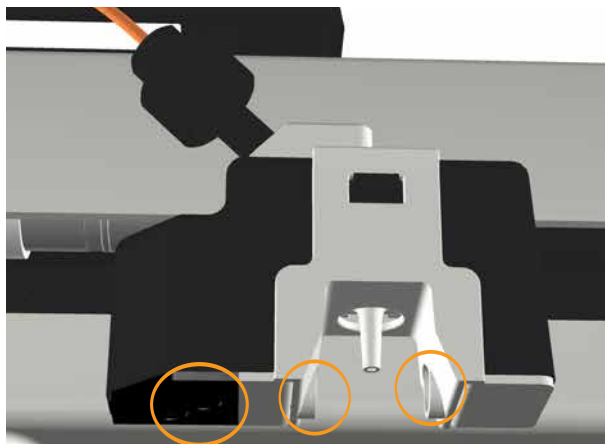

- 3 Let the Dispenser head dry completely before starting a run.
- 4 Close the fraction collector door.  
*Result:* Automatic scanning is performed.
- 5 In the System Control module, press the **End** icon in the toolbar.



*Result:* The Dispenser head moves to home position, and the Instrument display states **Ready**.

## 7.4 Monthly maintenance

### Introduction

This section provides instructions for monthly maintenance actions.

---

### Maintenance interval

Check the back pressure for the Flow restrictor every month.

---

### Location of the Flow restrictor

The recommended positions for Flow restrictor **FR-902** are:

- Connected between the Conductivity monitor **C9** and the Outlet valve.  
or
  - Connected to the **ToR** and **FrR** ports of the pH valve.
- 

### Check Flow restrictor connected to Conductivity monitor and Outlet valve

Follow the instructions below to check the back pressure of Flow restrictor **FR-902**, when this is connected between the Conductivity monitor and the Outlet valve.

Step	Action
1	Immerse the piece of inlet tubing marked <b>A1</b> in distilled water, and insert the piece of tubing from Outlet valve port <b>W</b> into a waste container.
2	In the <b>System Control</b> module, select <b>Manual:Execute Manual Instructions</b> . <i>Result:</i> The <b>Manual instructions</b> dialog opens.
3	In the <b>Manual instructions</b> dialog: <ul style="list-style-type: none"> <li>• Select <b>Flowpath:Injection valve</b>, and select <b>Manual Load</b>. Click <b>Insert</b>.</li> <li>• Select <b>Flowpath:Column valve</b>, and select <b>By-pass</b>. Click <b>Insert</b>.</li> <li>• Select <b>Flowpath:Outlet valve</b>, and select <b>Out-Waste</b>. Click <b>Insert</b>.</li> <li>• Select <b>Pumps:System flow</b> and set the <b>Flow rate</b> to 2.5 ml/min. Click <b>Insert</b>.</li> <li>• Click <b>Execute</b>.</li> </ul> <i>Result:</i> A system flow of 2.5 ml/min starts.
4	Note the <b>PreC pressure</b> displayed in the <b>Run Data</b> pane. <b>Tip:</b> <i>If PreC pressure is not displayed, click the <b>Customize</b> icon. In the <b>Customize</b> dialog, under the <b>Run Data Groups</b> tab, select <b>PreC pressure</b>.</i>

Step	Action
5	Click on the <b>Pause</b> icon to stop the flow.
6	Replace the Flow restrictor with a female/female union connector. <b>Tip:</b> <i>The female/female union connector is included in the accessory kit.</i>
7	Click the <b>Continue</b> icon to restart the flow.
8	Note the <b>PreC pressure</b> displayed in the <b>Run Data</b> pane.
9	Calculate the difference between the two pressure values.
10	Check that the pressure difference is within the range $0.2 \pm 0.05$ MPa. If this is not the case, the Flow restrictor should be replaced, see <a href="#">Section 7.8.7 Replace Flow restrictor, on page 330</a> .

## Check Flow restrictor connected to pH valve

Follow the instructions below to check the back pressure of Flow restrictor **FR-902**.

Step	Action
1	Immerse the piece of inlet tubing marked <b>A1</b> in distilled water, and insert the piece of tubing from Outlet valve port <b>W</b> into a waste container.
2	In the <b>System Control</b> module, select <b>Manual:Execute Manual Instructions</b> . <i>Result:</i> The <b>Manual instructions</b> dialog opens.
3	In the <b>Manual instructions</b> dialog: <ul style="list-style-type: none"><li>• Select <b>Flowpath:Injection valve</b>, and then select <b>Manual Load</b>. Click <b>Insert</b>.</li><li>• Select <b>Flowpath:Column valve</b>, and then select <b>By-pass</b>. Click <b>Insert</b>.</li><li>• Select <b>Flowpath:pH valve</b>, and set the pH electrode to <b>Off-line</b> and the Restrictor to <b>In-line</b>. Click <b>Insert</b>.</li><li>• Select <b>Flowpath:Outlet valve</b>, and then select <b>Out-Waste</b>. Click <b>Insert</b>.</li><li>• Select <b>Pumps:System flow</b> and set the <b>Flow rate</b> to 2.5 ml/min. Click <b>Insert</b>.</li><li>• Click <b>Execute</b>.</li></ul> <i>Result:</i> A system flow of 2.5 ml/min starts.
4	Note the <b>PreC pressure</b> displayed in the <b>Run Data</b> pane. <b>Tip:</b> <i>If PreC pressure is not displayed, click the <b>Customize</b> icon. In the <b>Customize</b> dialog, under the <b>Run Data Groups</b> tab, select <b>PreC pressure</b>.</i>

Step	Action
5	<p>In the <b>Manual instructions</b> dialog:</p> <ul style="list-style-type: none"><li>• Select <b>Flowpath:pH valve</b>, and set the pH electrode to <b>Off-line</b> and the Restrictor to <b>Off-line</b>.</li><li>• Click <b>Execute</b>.</li></ul>
6	<p>Note the <b>PreC pressure</b> displayed in the <b>Run Data</b> pane.</p>
7	<p>Calculate the difference between the two pressure values noted in step 4 and step 6.</p>
8	<p>Check that the pressure difference is within the range <math>0.2 \pm 0.05</math> MPa.</p> <p>If this is not the case, the Flow restrictor should be replaced, see <a href="#">Section 7.8.7 Replace Flow restrictor, on page 330</a>.</p>

## 7.5 Semiannual maintenance

### Introduction

This section provides instructions for semiannual maintenance activities.

---

### In this section

This section contains the following subsections:

Section	See page
7.5.1 Clean the UV flow cell	273
7.5.2 Replace the pH electrode	275

---



## 7.5.1 Clean the UV flow cell

### Maintenance interval

Clean the UV flow cell every six months, or when required.



#### NOTICE

**Keep UV flow cell clean.** Do not allow solutions containing dissolved salts, proteins or other solid solutes to dry out in the flow cell. Do not allow particles to enter the flow cell, as damage to the flow cell may occur.

### Required material

The following materials are required:

- Luer connector
- Waste container
- Syringe, 25-30 ml
- 10% surfactant detergent solution (e.g., Decon™ 90, Deconex 11, or RBS 25)
- Distilled water

### Instruction

Follow the instructions below to clean the UV flow cell for UV monitor **U9-M** or UV monitor **U9-L**. The UV flow cell can be mounted or not mounted on the instrument during the cleaning procedure.

The illustrations in the instructions below show UV monitor **U9-M**. UV monitor **U9-L** is cleaned in a corresponding way.

Step	Action
1	Disconnect the tubing from the top of the UV flow cell, and replace the fingertight connector with a Luer connector.

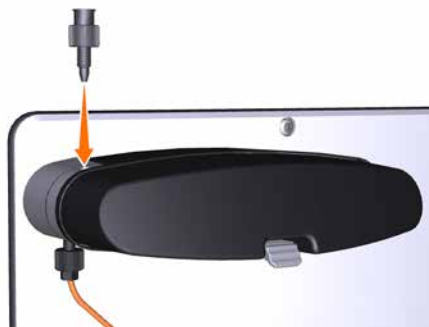

2	Disconnect the tubing from the bottom of the UV flow cell, and connect a piece of waste tubing to the UV flow cell. Insert the waste tubing into a waste container.
---	---

Step	Action
3	Fill a syringe with distilled water, and connect the syringe to the Luer connector. 
4	Squirt the distilled water through the UV flow cell in small amounts. Disconnect the syringe.
5	Fill a syringe with a 10% surfactant detergent solution, such as Decon 90, Deconex 11, RBS 25 or equivalent, and connect the syringe to the Luer connector. <b>Tip:</b> <i>Heat the 10% surfactant detergent solution to 40°C to increase the cleaning effect.</i>
6	Squirt the detergent solution through the UV flow cell about five times.
7	Leave the detergent solution in the flow cell for at least 20 minutes.
8	Inject the detergent solution remaining in the syringe into the flow cell. Disconnect the syringe.
9	Fill a syringe with distilled water. Connect the syringe to the Luer connector.
10	Inject the distilled water into the UV flow cell to rinse the flow cell. Disconnect the syringe.
11	Disconnect the Luer connector from the top of the UV flow cell. Reconnect the piece of tubing from the Column valve to the top of the UV flow cell.
12	Disconnect the waste tubing from the bottom of the UV flow cell. Reconnect the piece of tubing from the Conductivity monitor to the bottom of the UV flow cell.

## 7.5.2 Replace the pH electrode

### Maintenance interval

Replace the pH electrode every six months, or when required.

---

### Required material

The following materials are required:

- pH electrode
  - Deionized water
  - Standard buffer pH 4
- 

### Instruction



#### CAUTION

**pH-electrode.** Handle the pH-electrode with care. The glass tip may break and cause injury.

Follow the instructions below to replace the pH electrode.

Step	Action
1	Disconnect the pH electrode cable of the used pH electrode from the connection on the front of the pH valve.
2	Unscrew the nut of the pH electrode by hand, and pull the used electrode away.
3	Unpack the new pH electrode. Remove the cover from the tip of the new pH electrode. Make sure that the electrode is not broken or dry.
4	Prior to first use of the electrode, immerse the glass bulb in deionized water for 30 minutes and then in a standard buffer, pH 4, for 30 minutes.
5	Carefully insert the new pH electrode into the pH flow cell. Tighten the nut by hand to secure the electrode.
6	Connect the pH electrode cable of the new electrode to the connection on the front of the pH valve.
7	Calibrate the new pH electrode, see <a href="#">Section 7.7.1 Calibrate the pH monitor, on page 303</a> .

---

## 7.6 Maintenance when required

### Introduction

This section gives instructions for maintenance activities to be performed when required.

---

### In this section

This section contains the following subsections:

Section	See page
7.6.1 Clean the instrument externally	277
7.6.2 Perform System CIP	278
7.6.3 Perform Column CIP	284
7.6.4 Clean Fraction collector F9-C	288
7.6.5 Clean Fraction collector F9-R	290
7.6.6 Storage of the pH electrode	291
7.6.7 Clean the pH electrode	293
7.6.8 Clean the pump head check valves	296
7.6.9 Wipe off excess oil from the pump head	299
7.6.10 Clean the Conductivity flow cell	300

---

## 7.6.1 Clean the instrument externally

### Maintenance interval

Clean the the instrument externally when required. Do not allow spilled liquid to dry on the instrument.

---

### Required material

The following materials are required:

- Cloth
  - Mild cleaning agent or 20% ethanol
- 

### Instruction

Follow the instructions below to clean the instrument externally.

Step	Action
1	Check that no run is in progress.
2	Switch off the instrument.
3	Wipe the surface with a damp cloth. Wipe off stains using a mild cleaning agent or 20% ethanol. Wipe off any excess.
4	Let the instrument dry completely before using it.

---

## 7.6.2 Perform System CIP

### Maintenance interval

Perform a System cleaning in place (System CIP) when required, for example between runs where different samples and buffers are used. This is important to prevent cross-contamination and bacterial growth in the instrument.

---

### Required material

The following materials are required:

- Appropriate cleaning solutions (e.g., NaOH, buffer solution or distilled water).
  - Syringe, 25-30 ml
- 

### Introduction

The **System CIP** method is used to fill the instrument and the selected inlets and outlets with cleaning solution.



#### WARNING

**Hazardous biological agents during run.** When using hazardous biological agents, run **System CIP** and **Column CIP** to flush the entire system tubing with bacteriostatic solution (e.g., NaOH) followed by a neutral buffer and finally distilled water, before service and maintenance.



#### CAUTION

**Hazardous substances.** When using hazardous chemical and biological agents, take all suitable protective measures, such as wearing protective glasses and gloves resistant to the substances used. Follow local and/or national regulations for safe operation, maintenance and decommissioning of the equipment.



#### CAUTION

**Explosion hazard if flammable liquid leaks during cleaning of the flow path.** When cleaning the flow path of Fraction collector F9-C with a flammable liquid like ethanol, carefully inspect the flow path, including the waste tubing, to make sure there will be no leakage.

**Tip:** *If hazardous chemicals are used for system or column cleaning, wash the system or columns with a neutral solution in the last phase or step.*

---

## Create a System CIP method

Follow the instruction below to create a **System CIP** method.

Step	Action
------	--------

- |   |  |
|---|--|
| 1 | In the <b>Method Editor</b> module, <ul style="list-style-type: none"><li>click the <b>New Method</b> icon</li></ul> |
|---|--|



or

- select **File:New Method**.

*Result:* The **New Method** dialog opens.

- |   |  |
|---|--|
| 2 | In the <b>New Method</b> dialog, select <b>System</b> and then <b>System CIP</b> in the <b>Predefined Method</b> drop-down list. Click <b>OK</b> . |
|---|--|

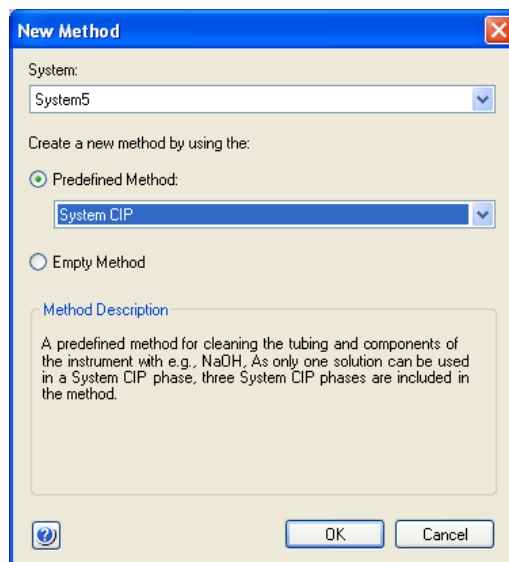

*Result:* One **Method Settings** phase and three **System CIP** phases show in the **Method Outline** pane. Each **System CIP** phase uses one cleaning solution.



- |   |  |
|---|--|
| 3 | If desired, add additional <b>System CIP</b> phases to the method using the <b>Phase Library</b> . |
|---|--|

**Step Action**

4 In the **Phase Properties** tab of each of the **System CIP** phases:

- Enter a note for the first solution (optional).
- Select values for **Flow rate**, **Volume per position** and **Incubation time**.

**System CIP**

This phase uses one solution

Solution note

Pause to manually move all inlets to the selected solution

Flow rate  ml/min [0.000 - 25.000]

Volume per position  ml

Incubation time  min

- Define the extent of cleaning by checking the check boxes.

**Note:**

For complete cleaning of the Injection valve, select at least one of the sample inlets and clean the manual injection port using a syringe (see [Clean the manual injection port of the Injection valve, on page 282](#)).

A inlets	B inlets	Sample inlets	Column Position	Outlets
<input checked="" type="checkbox"/> A1	<input type="checkbox"/> B1	<input type="checkbox"/> Buffer	<input checked="" type="checkbox"/> By-pass	<input checked="" type="checkbox"/> Waste
<input type="checkbox"/> A2	<input type="checkbox"/> B2	<input type="checkbox"/> S1	<input type="checkbox"/> 1	<input type="checkbox"/> Outlet 1
<input type="checkbox"/> A3	<input type="checkbox"/> B3	<input type="checkbox"/> S2	<input type="checkbox"/> 2	<input type="checkbox"/> Outlet 2
<input type="checkbox"/> A4	<input type="checkbox"/> B4	<input type="checkbox"/> S3	<input type="checkbox"/> 3	<input type="checkbox"/> Outlet 3
<input type="checkbox"/> A5	<input type="checkbox"/> B5	<input type="checkbox"/> S4	<input type="checkbox"/> 4	<input type="checkbox"/> Outlet 4
<input type="checkbox"/> A6	<input type="checkbox"/> B6	<input type="checkbox"/> S5	<input type="checkbox"/> 5	<input type="checkbox"/> Outlet 5
<input type="checkbox"/> A7	<input type="checkbox"/> B7	<input type="checkbox"/> S6		<input type="checkbox"/> Outlet 6
		<input type="checkbox"/> S7		<input type="checkbox"/> Outlet 7
				<input type="checkbox"/> Outlet 8
				<input type="checkbox"/> Outlet 9
				<input type="checkbox"/> Outlet 10 / Frac 2
<input type="checkbox"/> All	<input type="checkbox"/> All	<input type="checkbox"/> All	<input type="checkbox"/> All	<input type="checkbox"/> All

**Others**

System pump sample flow path

Injection valve with capillary loop

Fraction collector

Loop cleaning volume  ml

Number of loops

Second fraction collector

**Note:**

- The pH electrode and the pH valve are not included in the system CIP. Refer to [Section 7.6.7 Clean the pH electrode, on page 293](#) for instructions on how to clean the pH electrode.
- If the fraction collector is included, a lower flow rate might need to be set in the instruction **Fraction collector wash settings**.
- Make sure not to exceed the pressure limits for any of the modules that are part of the flow path during the CIP.

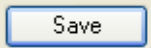

Step	Action
5	<p>In the <b>Method Editor</b> module,</p> <ul style="list-style-type: none"><li>click the <b>Save the method</b> icon</li></ul>  <p>or</p> <ul style="list-style-type: none"><li>select <b>File:Save As</b></li></ul> <p><i>Result:</i> The <b>Save As</b> dialog opens.</p>
6	<p>In the <b>Save As</b> dialog:</p> <ul style="list-style-type: none"><li>Select a target folder to enable the <b>Save</b> button.</li><li>Type a <b>Name</b> for the method.</li><li>Select a <b>System</b> from the list.</li><li>Click .</li></ul> <p><i>Result:</i> The created method is saved in the selected folder.</p>

## Perform a System CIP

Follow the instructions below to run a **System CIP** method.

Step	Action
1	In the <b>Method Editor</b> module, create a <b>System CIP</b> method according to the instructions above.
2	Connect bypass tubing to all selected column positions and loop positions if a loop valve is used.
3	Prepare cleaning solutions and immerse the selected inlet tubing in the solutions. <b>Note:</b> <i>Note that each phase uses one solution. All inlets selected in one phase should be immersed in the same cleaning solution.</i>
4	In the <b>System Control</b> module, select the created method and start the run.
5	For complete cleaning of the flow path, clean the manual injection port of the Injection valve and the pH valve manually, see the instructions below.

## Clean the manual injection port of the Injection valve

Follow the instructions below to manually clean the Manual load position of the Injection valve.

- | Step | Action   |
|------|--|
| 1    | In the <b>System Control</b> module, select <b>Manual:Execute Manual Instructions</b> .<br><i>Result:</i> The <b>Manual instructions</b> dialog opens. |
| 2    | In the <b>Manual instructions</b> dialog, select <b>Flowpath:Injection valve</b> , and select <b>Manual Load</b> . Click <b>Execute</b> .              |
| 3    | Connect a suitable sample loop to Injection valve ports <b>LoopF</b> (fill) and <b>LoopE</b> (empty).  |

**Note:**

*Do not use a Superloop when cleaning the Injection valve.*



- |   |   |
|---|---|
| 4 | Connect tubing to Injection valve port <b>W1</b> , and direct this tubing to a waste container.   |
| 6 | Fill a syringe with approximately 10 ml of an appropriate cleaning solution (e.g., NaOH or buffer solution). Connect the syringe to Injection valve port <b>Syr</b> , and inject the cleaning solution. |



- |   |   |
|---|---|
| 6 | Fill a syringe with distilled water. Connect the syringe to Injection valve port <b>Syr</b> , and inject the distilled water. |
|---|---|

## Clean the pH valve

Follow the instructions below to clean the pH valve. The calibration function is used to switch the valve position. However, no calibration is performed.

- | Step | Action  |
|------|---|
| 1    | Connect tubing to pH valve port <b>W3</b> , and direct the other end of this tubing to a waste container.                         |
| 2    | Unscrew the pH electrode from the pH valve, and replace it with the dummy electrode.  |
| 3    | Open the <b>System Control</b> module and select <b>System:Calibrate</b> .<br><i>Result:</i> The <b>Calibration</b> dialog opens. |

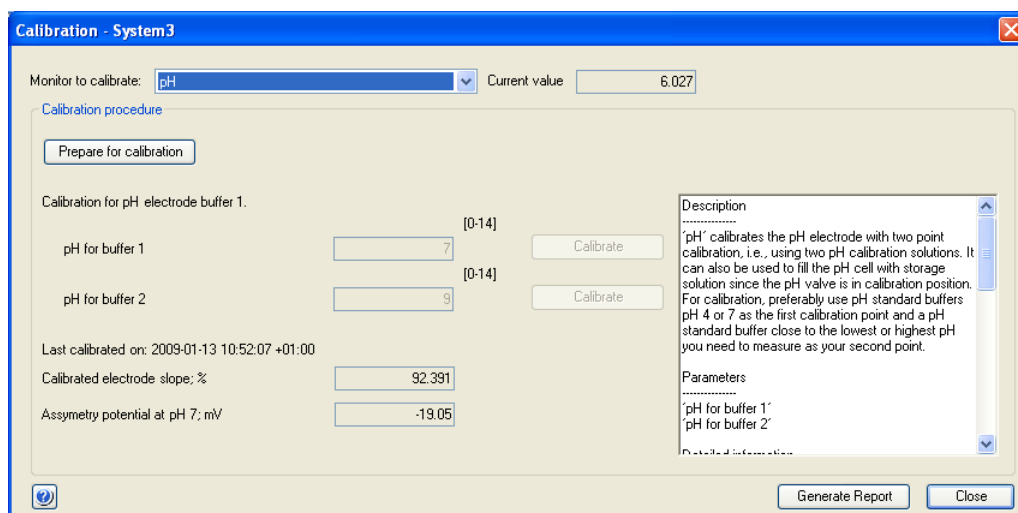

- In the **Calibration** dialog, select **pH** from the **Monitor to calibrate** drop-down list.
- Press the **Prepare for calibration** button.

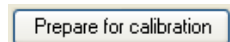

*Result:* The pH valve switches to the calibration position.

- Fill a syringe with approximately 10 ml of 1 M NaOH. Connect the syringe to the pH valve port **Cal**, and inject the solution.
- Fill a syringe with distilled water. Connect the syringe to the pH valve port **Cal**, and inject the distilled water.
- Press the **Close** button.

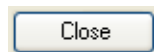

*Result:* The pH valve switches back to the default position and the **Calibration** dialog closes. No calibration is performed.

## 7.6.3 Perform Column CIP

### Maintenance interval

Perform a Column cleaning in place (Column CIP) when required, for example between runs where different samples are used.

---

### Required material

The following materials are required:

- Appropriate cleaning solutions. Please refer to the instructions for use of the column.
- 

### Introduction

The **Column CIP** method is used to clean the column after purification runs, to remove non-specifically bound proteins and to minimize the risk for carry-over between different purification runs.



#### WARNING

**Hazardous biological agents during run.** When using hazardous biological agents, run **System CIP** and **Column CIP** to flush the entire system tubing with bacteriostatic solution (e.g., NaOH) followed by a neutral buffer and finally distilled water, before service and maintenance.



#### CAUTION

**Hazardous substances.** When using hazardous chemical and biological agents, take all suitable protective measures, such as wearing protective glasses and gloves resistant to the substances used. Follow local and/or national regulations for safe operation, maintenance and decommissioning of the equipment.

**Tip:** *If hazardous chemicals are used for system or column cleaning, wash the system or columns with a neutral solution in the last phase or step.*

---

## Create a Column CIP method

Follow the instruction below to create a **Column CIP** method.

Step	Action
------	--------

- |   |  |
|---|--|
| 1 | In the <b>Method Editor</b> module, <ul style="list-style-type: none"><li>click the <b>New Method</b> icon</li></ul> |
|---|--|



or

- select **File:New Method**.

*Result:* The **New Method** dialog opens.

- |   |   |
|---|---|
| 2 | In the <b>New Method</b> dialog, select <b>System</b> and then <b>Predefined Method</b> and <b>Column CIP</b> . Click <b>OK</b> . |
|---|---|

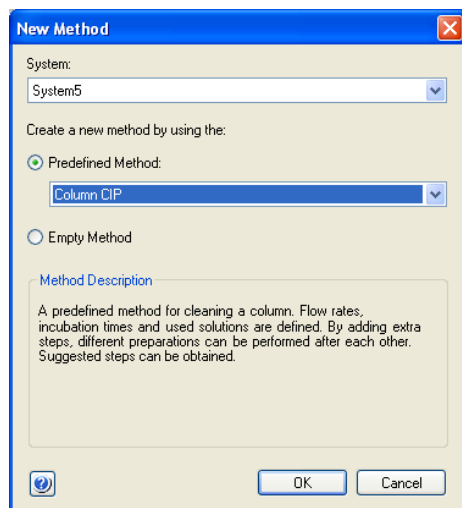

*Result:* One **Method Settings** phase and one **Column CIP** phase will be displayed in the **Method Outline** pane.

- |   |  |
|---|--|
| 3 | In the <b>Phase Properties</b> tab of the <b>Method Settings</b> phase, select <b>Column type</b> and <b>Column position</b> . |
|---|--|

**Step Action**

4 In the **Phase Properties** tab of the **Column CIP** phase:

- Click **Add Step** to add a step.
- Select the step and click **Remove Step** to remove a step.
- To enter a value, select the cell and enter or select a new value.

**Column CIP**

	CIP solution note	Inlet A	Inlet B	%B (0-100)	Linear gradient	Fill System	Volume (CV)	Flow Rate (0-25) ml/min	Flow direction	Outlet	Incubation time (min)
1		A1	B1	0.00	<input type="checkbox"/>	<input checked="" type="checkbox"/>	1.00	1.000	Down flow	Out-Waste	0.00

5 In the **Phase Properties** tab of the **Column CIP** phase, click the **Get Suggested Steps** button to get a suggested procedure for the selected column type. Note that this function is not available for all column types.

*Result:* Suggested cleaning steps for the selected column type are displayed.

	CIP solution note	Inlet A	Inlet B	%B (0-100)	Linear gradient	Fill System	Volume (CV)	Flow Rate (0-25) ml/min	Flow direction	Outlet	Incubation time (min)
1	2M NaCl	A1	B1	0.00	<input type="checkbox"/>	<input checked="" type="checkbox"/>	2.00	2.500	Down flow	Out-Waste	0.00
2	1M NaOH	A1	B1	0.00	<input type="checkbox"/>	<input checked="" type="checkbox"/>	4.00	2.500	Down flow	Out-Waste	0.00
3	2M NaCl	A1	B1	0.00	<input type="checkbox"/>	<input checked="" type="checkbox"/>	2.00	2.500	Down flow	Out-Waste	0.00
4	Water	A1	B1	0.00	<input type="checkbox"/>	<input checked="" type="checkbox"/>	2.00	2.500	Down flow	Out-Waste	0.00
5	Equilibration/storage ...	A1	B1	0.00	<input type="checkbox"/>	<input checked="" type="checkbox"/>	4.00	2.500	Down flow	Out-Waste	0.00

6 If several cleaning solutions are used, change settings for **Inlet A** and/or **Inlet B**. Select one inlet for each solution. If Inlet B is used, remember to edit the values in the **%B** column.

	CIP solution note	Inlet A	Inlet B	%B (0-100)	Linear gradient	Fill System	Volume (CV)	Flow Rate (0-25) ml/min	Flow direction	Outlet	Incubation time (min)
1	2M NaCl	A1	B1	0.00	<input type="checkbox"/>	<input checked="" type="checkbox"/>	2.00	2.500	Down flow	Out-Waste	0.00
2	1M NaOH	A2	B1	0.00	<input type="checkbox"/>	<input checked="" type="checkbox"/>	4.00	2.500	Down flow	Out-Waste	0.00
3	2M NaCl	A1	B1	0.00	<input type="checkbox"/>	<input checked="" type="checkbox"/>	2.00	2.500	Down flow	Out-Waste	0.00
4	Water	A3	B1	0.00	<input type="checkbox"/>	<input checked="" type="checkbox"/>	2.00	2.500	Down flow	Out-Waste	0.00
5	Equilibration/storage ...	A4	B1	0.00	<input type="checkbox"/>	<input checked="" type="checkbox"/>	4.00	2.500	Down flow	Out-Waste	0.00

Step	Action
7	<p>In the <b>Method Editor</b> module,</p> <ul style="list-style-type: none"><li>click the <b>Save the method</b> icon</li></ul>  <p>or</p> <ul style="list-style-type: none"><li>select <b>File:Save As</b></li></ul> <p><i>Result:</i> The <b>Save As</b> dialog opens.</p>
8	<p>In the <b>Save As</b> dialog:</p> <ul style="list-style-type: none"><li>Select a target folder to enable the <b>Save</b> button.</li><li>Type a <b>Name</b> for the method.</li><li>Select a <b>System</b> from the list.</li><li>Click the <b>Save</b> button.</li></ul> <p><i>Result:</i> The created method is saved in the selected folder.</p>

## Perform a Column CIP

Follow the instructions below to run a **Column CIP** method.

Step	Action
1	In the <b>Method Editor</b> module, create a <b>Column CIP</b> method according to the instruction above.
2	Prepare cleaning solutions and immerse the selected inlets in the solutions.
3	Connect the column to the selected column position.
4	In the <b>System Control</b> module, select the created method and start the run.

## 7.6.4 Clean Fraction collector F9-C

### Maintenance interval

Clean the Fraction collector when required, for example if liquid has been spilled in the Fraction collector chamber. The internal tubing of the fraction collector may need to be replaced for maintenance or for process purposes. Information on how and when to replace the internal tubing can be found in the ÄKTA pure *User manual*.

### Required material

The following materials are required:

- Wash bottle
- Water or 20% ethanol
- Cloth

### Instruction

Follow the instruction below to clean the interior of the Fraction collector. The locations of the components of the fraction collector are shown in [Section 3.2.2 Fraction collector F9-C illustrations, on page 92](#).

Step	Action
1	Perform a fraction collector wash: In <b>System Control</b> , select <b>Manual:Execute Manual Instructions:Fraction collection:Fraction collector wash</b> . Click <b>Execute</b> .



#### NOTICE

- If no column valve is used, make sure to replace any columns in the flow path with tubing before a fraction collector wash is performed.
- Lower the flow for the fraction collector wash in the instruction **Fraction collector wash settings** if the system back pressure is elevated during the wash.
- Make sure not to exceed the pressure limits for any of the modules that are part of the flow path.

2	In <b>System Control</b> , select <b>Manual:Execute Manual Instructions:Fraction collection:Fraction cleaning position</b> . Click <b>Execute</b> .
---	---

**Result:** The Dispenser head moves to cleaning position, and the Instrument display states **System pause**.

3	Open the door of the fraction collector and remove the rack
---	---



Step	Action
4	Wash the Cassette tray or rack and the Cassettes (if applicable), with water and a mild cleaning agent.
5	Lift off the Waste funnel and wash it with water and a mild cleaning agent. Refit the Waste funnel.
6	Wipe off the interior of the fraction collector using a damp cloth. Wipe off stains using a mild cleaning agent or 20% ethanol.
7	Wipe off the Dispenser head and its diode windows (the Drop sync sensor and the Type code reader) using a wash bottle with water or 20% ethanol and a cloth.
8	Let the fraction collector dry completely before starting a run.
9	Close the door of the fraction collector. <i>Result:</i> Automatic scanning is performed.
10	In the System Control module, press the <b>End</b> icon in the toolbar. <i>Result:</i> The Dispenser head moves to home position.

## 7.6.5 Clean Fraction collector F9-R

### Maintenance interval

Clean the Fraction collector when required, for example in case of liquid spill.

---

### Required material

The following materials are required:

- Water or 20% ethanol
  - Cloth
- 

### Clean the instrument

Follow the instructions below to clean the instrument externally.

Step	Action
1	Check that no run is in progress.
2	Switch off the instrument.
3	Wipe the surface with a damp cloth. Wipe off stains using a mild cleaning agent or 20% ethanol. Wipe off any excess.
4	Let the Fraction collector F9-R dry completely before restart.

---

### Clean DropSync sensor

Clean the drop sensor photocell located above the tube sensor (see [Front view illustration, on page 103](#)) with a damp cloth.

---

## 7.6.6 Storage of the pH electrode

### Maintenance interval

When pH monitoring is not used, the pH electrode can be stored in storage solution inside the pH flow cell. If pH monitoring is not used for a week or longer, inject new storage solution into the pH flow cell or replace the pH electrode with the dummy electrode that was installed in the pH valve on delivery.

### Required material

The following materials are required:

- Syringe, 25 to 30 ml
- Storage solution (1:1 mixture of standard buffer, pH 4, and 1 M KNO<sub>3</sub>)

### Instruction

Follow the instructions below to fill the pH flow cell with storage solution. The calibration function is used to switch the position of the pH valve. However, no calibration is performed.

Step	Action
1	In the <b>System Control</b> module, on the <b>System</b> menu click <b>Calibrate</b> . Result: The <b>Calibration</b> dialog opens.
2	In the <b>Calibration</b> dialog, click <b>pH</b> on the <b>Monitor to calibrate</b> drop-down list.
3	Click <b>Prepare for Calculation</b> . Result: The pH valve switches to the calibration position.
4	Prepare at least 10 ml storage solution by mixing equal volumes of a standard buffer, pH 4, and a 1 M Potassium Nitrate (KNO <sub>3</sub> ) solution.

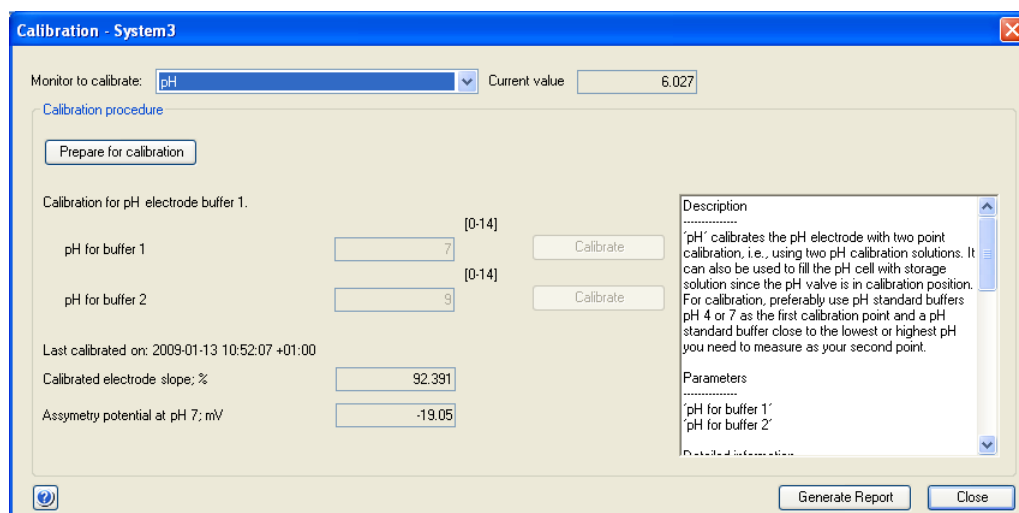

## 7 Maintenance

### 7.6 Maintenance when required

#### 7.6.6 Storage of the pH electrode

Step	Action
5	Fill a syringe with approximately 10 ml of the storage solution. Connect the syringe to the pH valve port <b>Cal</b> , and inject the storage solution.



6	Click <b>Close</b> . <i>Result:</i> The pH valve switches back to the default position and the <b>Calibration</b> dialog closes. No calibration is performed.
---	--

## 7.6.7 Clean the pH electrode

### Maintenance interval

Clean the pH electrode when required. The pH electrode can be cleaned either when it is installed in the pH valve or when it has been removed. The pH electrode has a limited longevity and should be replaced every six months or when the response time is slow, see [Section 7.5.2 Replace the pH electrode, on page 275](#). After cleaning has been performed, re-calibrate the pH monitor, see [Section 7.7.1 Calibrate the pH monitor, on page 303](#).

---

### Required material

The following materials are required:

- Syringe, 25-30 ml
  - Distilled water
  - 0.1 M HCl and 0.1 M NaOH  
or
  - Liquid detergent  
or
  - 1% pepsin solution in 0.1 M HCl  
or
  - 1 M KNO<sub>3</sub>
- 

### Cleaning agents

Clean the pH electrode using one of the following procedures:

#### Salt deposits

Dissolve the deposits by immersing the electrode for a five minute period in each of the following solutions:

- 0.1 M HCl
- 0.1 M NaOH
- 0.1 M HCl

Rinse the electrode tip in distilled water between each solution.

#### Oil or grease films

Wash the electrode tip in liquid detergent and water. If the films are known to be soluble in a particular organic solvent, wash with this solvent. Rinse the electrode tip in distilled water.

#### Protein deposits

Dissolve the deposit by immersing the electrode in a solution of 1% pepsin in 0.1 M HCl for five minutes, followed by thorough rinsing with distilled water.

If these procedures fail to rejuvenate the electrode, try the following procedure.

**Note:** This procedure can be performed only when the pH electrode is not installed in the pH valve.

Step	Action
1	Heat a 1 M KNO <sub>3</sub> solution to 60°C–80°C.
2	Place the electrode tip in the heated KNO <sub>3</sub> solution.
3	Allow the electrode to cool while immersed in the KNO <sub>3</sub> solution before re-testing.

If these steps fail to improve the electrode, replace the electrode, see [Section 7.5.2 Replace the pH electrode, on page 275](#).

## Clean a pH electrode installed in the pH valve

Follow the instructions below to clean a pH electrode installed in the pH valve. The calibration function is used to switch the position of the pH valve. However, no calibration is performed.

Step	Action
1	Open the <b>System Control</b> module and select <b>System:Calibrate</b> . <i>Result:</i> The <b>Calibration</b> dialog opens.

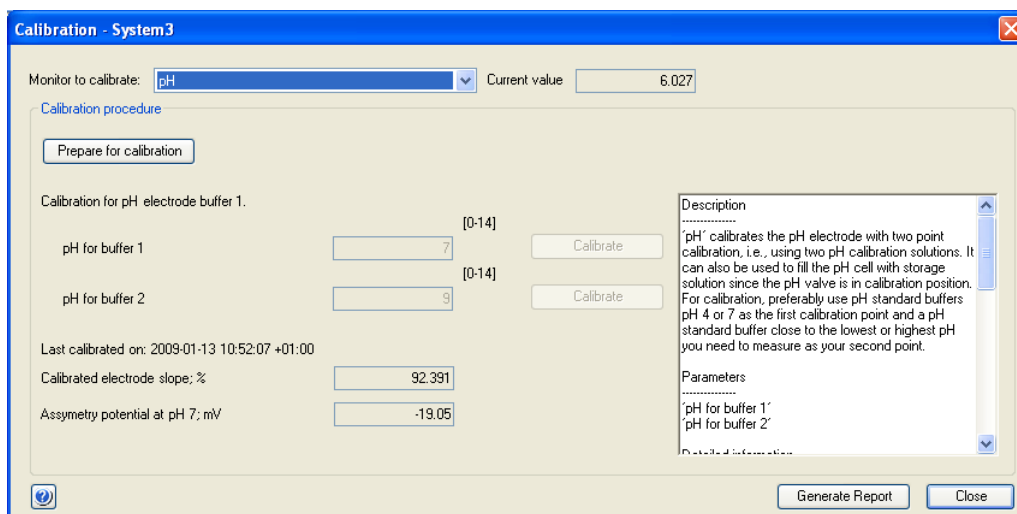

- Set **Monitor to calibrate** by selecting **pH** from the list.
- Press the **Prepare for calibration** button.

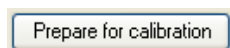

*Result:* The pH valve switches to the calibration position.

Step	Action
4	Fill a syringe with approximately 10 ml of chosen cleaning solution. Connect the syringe to the pH valve port <b>Cal</b> . Inject the liquid and wait for 5 minutes. Disconnect the syringe.



- 5 If several cleaning solutions are to be used, repeat step 4 with distilled water and then with the next solution.
- 6 As the last step in the cleaning procedure:
  - Fill a syringe with distilled water.
  - Connect the syringe to the pH valve port **Cal**.
  - Inject the water.
  - Disconnect the syringe.
- 7 Press the **Close** button.

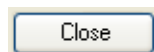

*Result:* The pH valve switches back to the default position and the **Calibration** dialog closes. No calibration is performed.

## 7.6.8 Clean the pump head check valves

### Maintenance interval

Clean the check valves when required, for example if solids in the check valve cause irregular or low flow. The cleaning procedure is the same for the system pumps and the sample pump.

---

### Required material

The following materials are required:

- Adjustable wrench
  - Methanol
  - Distilled water
  - Ultrasonic bath
- 

### Instruction

Follow the instructions below to remove and clean the pump head check valves.

Step	Action
1	Switch off the instrument.
2	Disconnect the tubing from the pump head and disconnect the pump inlet tubing. Disconnect the tubing of the pump rinsing system.
3	Unscrew the purge valve by turning it counter-clockwise, and lift off the metal ring.

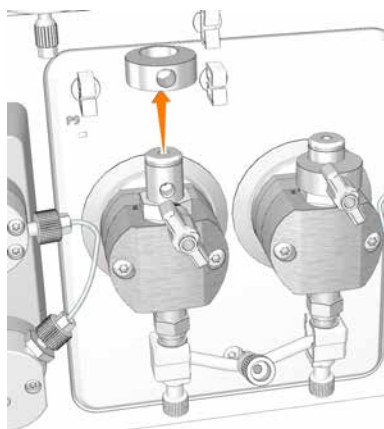



- | Step | Action  |
|------|---|
| 4    | Unscrew the plastic nut of the upper check valve using an adjustable wrench, and gently lift off the upper check valve. |

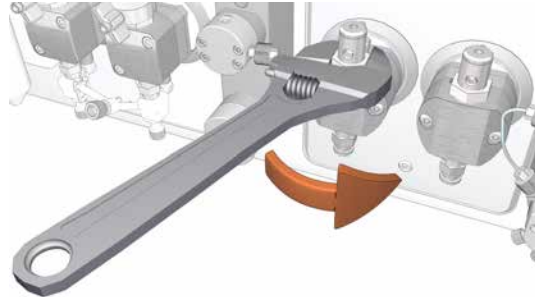

- |   |  |
|---|--|
| 5 | Unscrew the two white plastic screws located below each pump head. Pull the plastic connectors to the sides to release the inlet manifold. |
|---|--|

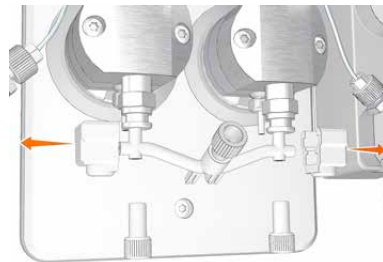

- |   |   |
|---|---|
| 6 | Unscrew the lower check valve using an adjustable wrench. |
|---|---|

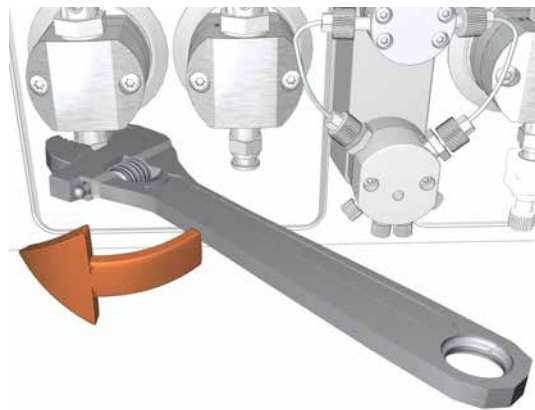

## 7 Maintenance

### 7.6 Maintenance when required

#### 7.6.8 Clean the pump head check valves

Step	Action
7	<div data-bbox="448 342 549 434"></div> <p data-bbox="588 338 719 368"><b>CAUTION</b></p> <p data-bbox="588 385 1406 561"><b>Hazardous substances.</b> When using hazardous chemical and biological agents, take all suitable protective measures, such as wearing protective glasses and gloves resistant to the substances used. Follow local and/or national regulations for safe operation, maintenance and decommissioning of the equipment.</p>
	Immerse the valves completely in methanol and place them in an ultrasonic bath for a few minutes. Repeat the ultrasonic bath with deionized water.
8	Refit the check valves.
9	Tighten the nut until fully finger-tight and then use the adjustable wrench to tighten a further 90 degrees.
10	Refit the inlet manifold and reconnect the tubing to the pump head.

## 7.6.9 Wipe off excess oil from the pump head

### Maintenance interval

During the first months of use it is normal that excess oil leaks out of the drain hole below the System pump. The function of the pump is not in any way affected by this.

---

### Required material

The following materials are required:

- Cloth
  - Mild cleaning agent or 20% ethanol
- 

### Instruction

Follow the instructions below to clean the System pumps externally.

Step	Action
1	Check that no run is in progress.
2	Switch off the instrument.
3	Wipe off the excess oil from the pump head with a damp cloth. Wipe off stains using a mild cleaning agent or 20% ethanol.
4	Let the pump dry completely before using the instrument.

---

## 7.6.10 Clean the Conductivity flow cell

### Maintenance interval

Clean the Conductivity flow cell when required.

---

### Required material

The following materials are required:

- Luer connector
  - Waste container
  - Syringe, 25-30 ml
  - 1 M NaOH
  - Distilled water
- 

### Instruction

Follow the instruction below to clean the flow cell of the Conductivity monitor.

Step	Action
1	Disconnect the fingertight connector and the piece of tubing from the top of the Conductivity monitor, and attach a Luer connector.

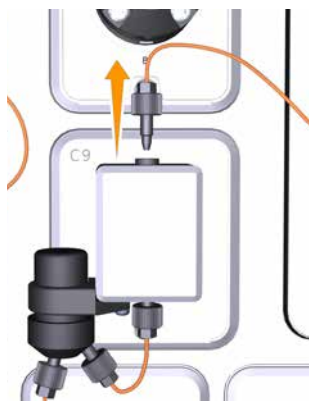

2	Disconnect the piece of tubing from the bottom of the Conductivity monitor, and connect a piece of waste tubing to the Conductivity monitor. Place the waste tubing in a waste container.
---	---

Step	Action
3	Fill a syringe with distilled water, and connect the syringe to the Luer connector.
	 A 3D illustration showing a syringe with a clear barrel and a black plunger, connected to a square-shaped conductivity flow cell labeled 'C9'. The syringe is inserted into a Luer lock connector on top of the flow cell. An orange tube is connected to the bottom of the flow cell, leading to a black cylindrical component, likely a pump or waste container.
4	Squirt distilled water through the Conductivity flow cell in small amounts. Disconnect the syringe.
5	Fill a syringe with 1 M NaOH, and connect the syringe to the Luer connector.
6	Squirt 1 M NaOH through the Conductivity flow cell about five times.
7	Leave the liquid in the flow cell for at least 15 minutes.
8	Fill a syringe with distilled water. Connect the syringe to the Luer connector.
9	Inject the distilled water into the Conductivity flow cell to rinse the flow cell. Disconnect the syringe.
10	Disconnect the Luer connector from the top of the Conductivity flow cell, and reconnect the fingertight connector with tubing.

## 7.7 Calibration procedures

### Introduction

This section provides instructions for calibration procedures that can be performed using the **System Control** module in UNICORN software.

---

### In this section

This section contains the following subsections:

Section	See page
7.7.1 Calibrate the pH monitor	303
7.7.2 Calibrate the pressure monitors	305
7.7.3 Calibrate the Conductivity monitor	308
7.7.4 Calibrate the UV monitors	312

---

### Menu command in UNICORN

Open the **System Control** module and select **System:Calibrate** to open the **Calibration** dialog.

---

## 7.7.1 Calibrate the pH monitor

### Maintenance interval

Calibrate the pH monitor once a day, when the pH electrode has been replaced, or if the ambient temperature has changed by more than  $\pm 5^{\circ}\text{C}$ .

---

### Required material

Use two pH calibration buffers with a difference of at least one pH unit. Preferably use a pH standard buffer, pH 4 or pH 7, as the first calibration point, and a pH standard buffer close to the lowest or highest pH you need to measure as your second point. Allow the buffers to equilibrate to ambient temperature before use.

---

### Instruction



#### CAUTION

**pH-electrode.** Handle the pH-electrode with care. The glass tip may break and cause injury.

Follow the instructions below to calibrate the pH monitor.

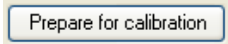
- | Step | Action   |
|------|--|
| 1    | In the <b>Calibration</b> dialog, select <b>pH</b> from the <b>Monitor to calibrate</b> drop-down list.  |
| 2    | Click the <b>Prepare for calibration</b> button.<br><br><i>Result:</i> The pH valve switches to the calibration position. |
| 3    | Enter the pH of the first pH standard buffer in the <b>pH for buffer 1</b> field.  |

Step	Action
4	Fill a syringe with approximately 10 ml of the first pH standard buffer. Connect the syringe to the Luer connector of pH valve port <b>Cal</b> , and inject the buffer.



- 5 When the **Current value** is stable, click the **Calibrate** button.

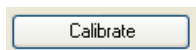

- 6 Wash the pH flow cell by injecting water into pH valve port **Cal** using a new syringe.

- 7 Enter the pH of the second pH standard buffer in the **pH for buffer 2** field.

- 8 Repeat steps 4-6 using the second pH standard buffer.

*Result:* The calibration date and time are displayed in the dialog, along with values for **Calibrated electrode slope** and **Asymmetry potential at pH 7**.

- 9 Is the **Calibrated electrode slope**  $\geq 80\%$  and the **Asymmetry potential at pH 7** inside the interval  $\pm 60$  mV?

- If Yes: Click the **Close** button to switch the pH valve back to the default position and to close the **Calibration** dialog.

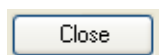

- If No: Clean the pH electrode and repeat the calibration procedure. If this does not help, replace the electrode.



## 7.7.2 Calibrate the pressure monitors

### Maintenance interval

ÄKTA pure can have up to four pressure monitors: System pump pressure monitor, Sample pump pressure monitor, Pre-column pressure monitor and Post-column pressure monitor. Check the pressure monitors every week, or when the ambient temperature has changed by more than  $\pm 5^\circ\text{C}$ . Calibrate the monitor if the zero pressure reading is outside the range  $\pm 0.02$  MPa.

---

### Check the monitors

Follow the instructions below to check the pressure monitors. The procedure is the same for each monitor.

Step	Action
1	Disconnect the relevant tubing from the pressure monitor to obtain zero-pressure, see table <a href="#">Tubing and pressures, on page 306</a> .
2	Click the <b>Customize</b> icon to open the <b>Customize</b> dialog. In the <b>Customize</b> dialog, under the <b>Run Data Groups</b> tab, select the relevant pressure to display, see table <a href="#">Tubing and pressures, on page 306</a> . Click <b>OK</b> to close the <b>Customize</b> dialog.
3	In the <b>Run Data</b> pane in the <b>System Control</b> module, check what pressure is displayed.
4	If the zero pressure reading is outside the range $\pm 0.02$ MPa, calibrate the pressure monitor according to the instruction below.

---

### Calibrate the monitors

Follow the instructions below to calibrate any of the pressure monitors.

Step	Action
1	Disconnect the relevant tubing from the pressure monitor, see table <a href="#">Tubing and pressures, on page 306</a> .
2	In the <b>Calibration</b> dialog, select the pressure monitor to calibrate from the <b>Monitor to calibrate</b> drop-down list.
3	Click the <b>Reset pressure</b> button. <i>Result:</i> The atmospheric pressure is defined as zero. The date and time of the most recent calibration, and the current pressure value are displayed.
4	Reconnect the tubing to the pressure monitor.

---

## Tubing and pressures

The table below shows the tubing to disconnect when checking and calibrating the pressure monitors. The UNICORN names of the pressures measured by the monitors are also shown.

Pressure monitor	Tubing to disconnect	Pressure in UNICORN
System pump pressure monitor	Tubing from the System pump pressure monitor 	<b>System pressure</b>
Sample pump pressure monitor	Tubing from the Sample pump pressure monitor 	<b>Sample pressure</b>
Pre-column pressure monitor	Tubing to Column valve port In (V9-C, V9H-C or V9-C2, V9H-C2). 	<b>PreC pressure</b>

Pressure monitor	Tubing to disconnect	Pressure in UNICORN
Post-column pressure monitor	Tubing to Column valve port <b>Out (V9-C, V9H-C or V9-C2, V9H-C2)</b> .  A close-up photograph of a column valve assembly. The valve is mounted on a white rectangular plate. The valve body is black and has several ports. A red arrow points to the 'Out' port, which is located between the '3A' and '4A' markings on the valve's rotation scale. Two orange tubes are connected to the left side of the valve.	<b>PostC pressure</b>

## 7.7.3 Calibrate the Conductivity monitor

### Introduction

Two types of calibrations can be performed:

- **Conductivity monitor - factory calibration:** Restores the conductivity cell constant to the factory default value.
  - **Conductivity monitor - user calibration:** Calibrates the conductivity cell constant.
- 

### Maintenance interval

Recommended maintenance intervals for the two types of calibrations:

- **Conductivity monitor - factory calibration:** Perform calibration to override an incorrect user calibration.
  - **Conductivity monitor - user calibration:** The conductivity cell is factory calibrated, and should not require recalibration under normal usage. Perform calibration when the signal is unstable or you suspect that it is incorrect. It is also recommended to recalibrate the Conductivity monitor after cleaning.
- 

### Conductivity monitor - factory calibration

Follow the instruction below to restore the conductivity cell constant to the factory default value.

Step	Action
1	In the <b>Calibration</b> dialog, select <b>Conductivity monitor - factory calibration</b> from the <b>Monitor to calibrate</b> drop-down list. <i>Result:</i> The time for the new calibration and the current value are displayed.
2	Click <b>Restore</b> . <i>Result:</i> The conductivity cell constant is restored to the factory default value. The conductivity cell constant is written on the packaging of the Conductivity monitor.

---

### Conductivity monitor - user calibration

Follow the instruction below to calibrate the Conductivity flow cell constant.

Step	Action
1	Make sure that the instrument has been switched on for at least one hour.
2	In the <b>System Control</b> module, select <b>System:Settings</b> . <i>Result:</i> The <b>System Settings</b> dialog opens.

**Step Action**

- 3 In the **System Settings** dialog, select **Conductivity** and **Cond temp compensation**. Set the **Compensation factor** to 0%, and click **OK**.

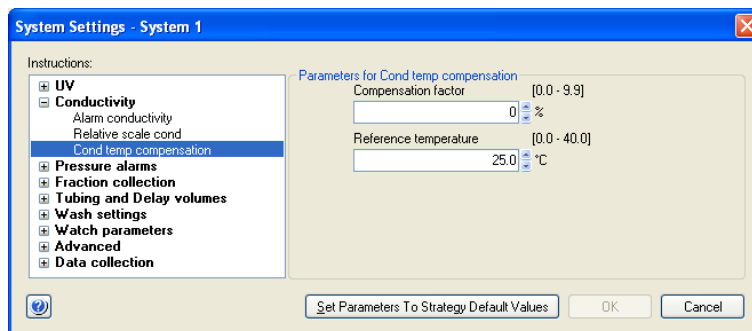

- 4 Wash the whole flow path and fill it with deionized water using a suitable inlet and the System pump, until the conductivity value reaches 0.00 mS/cm.
- 5 Connect the tubing (labelled 3) from the system pump pressure monitor directly to the conductivity cell inlet, by-passing the Mixer, Injection valve, Column valve and UV-monitor, see image below. Ensure that the Flow restrictor is inline.

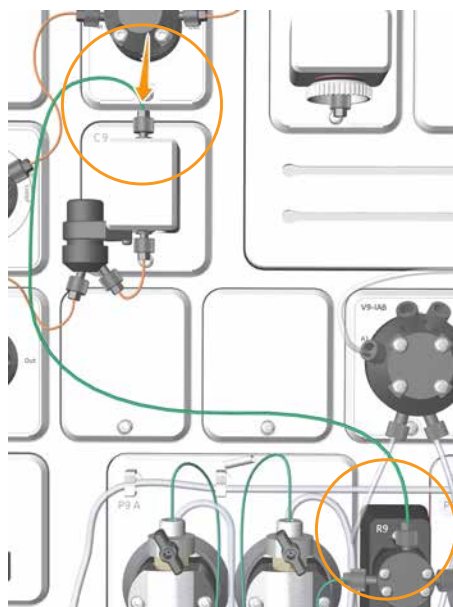

- 6 Prime and purge the inlet used in step 4 with the 1.00 M NaCl calibration solution. Fill the conductivity cell with the calibration solution at 1 ml/min. Pump in at least 15 ml of the calibration solution and wait until the conductivity signal and the temperature have stabilized before continuing the calibration. See [Section 5.4.1 System pumps, on page 161](#).
- 7 Under continuous flow, read the current Conductivity temperature from **Run Data** with an accuracy of one decimal place.
- 8 In the **Calibration** dialog, select **Conductivity monitor - user calibration** from the **Monitor to calibrate** drop-down list.

Step	Action
9	<p>In the <b>Run Data</b> pane of <b>System Control</b>, read the current <b>Cond temp</b>.</p> <p><b>Tip:</b> If <b>Cond temp</b> is not showing, click the <b>Customize</b> icon. In the <b>Customize</b> dialog, under the <b>Run Data Groups</b> tab, select to view <b>Cond temp</b>.</p>
10	<p>In the <b>Calibration</b> dialog, enter the theoretical conductivity value at the current conductivity temperature in the <b>Enter theoretical conductivity value</b> input field.</p> <ul style="list-style-type: none"><li>• If a certified conductivity standard solution is used, use the supplied theoretical conductivity value.</li><li>• If a manually prepared 1.00 M NaCl calibration solution is used, see the graph for conductivity value at the current temperature <a href="#">on page 311</a>.</li></ul>
11	<p>In the <b>Calibration</b> dialog, click <b>Calibrate</b>.</p> <p><b>Result:</b> The new conductivity cell constant is displayed in the <b>Conductivity cell 1 constant/cm</b> box. The new constant should normally be <math>40 \pm 10 \text{ cm}^{-1}</math>. The date and time for the calibration are also displayed.</p>
12	<p>In the <b>System Control</b> toolbar, click the <b>End</b> icon to end the run.</p>
13	<p>In the <b>System Settings</b> dialog, select <b>Conductivity:Cond temp compensation</b> and set the <b>Compensation factor</b> back to desired value, default 2.0%. Click <b>OK</b>.</p> <p><b>Note:</b> When using NaCl, the optimal compensation factor is 2.1%.</p>

## Graph for conductivity value

The graph below shows the conductivity value at the current temperature when 1.00 M NaCl calibration solution is used.

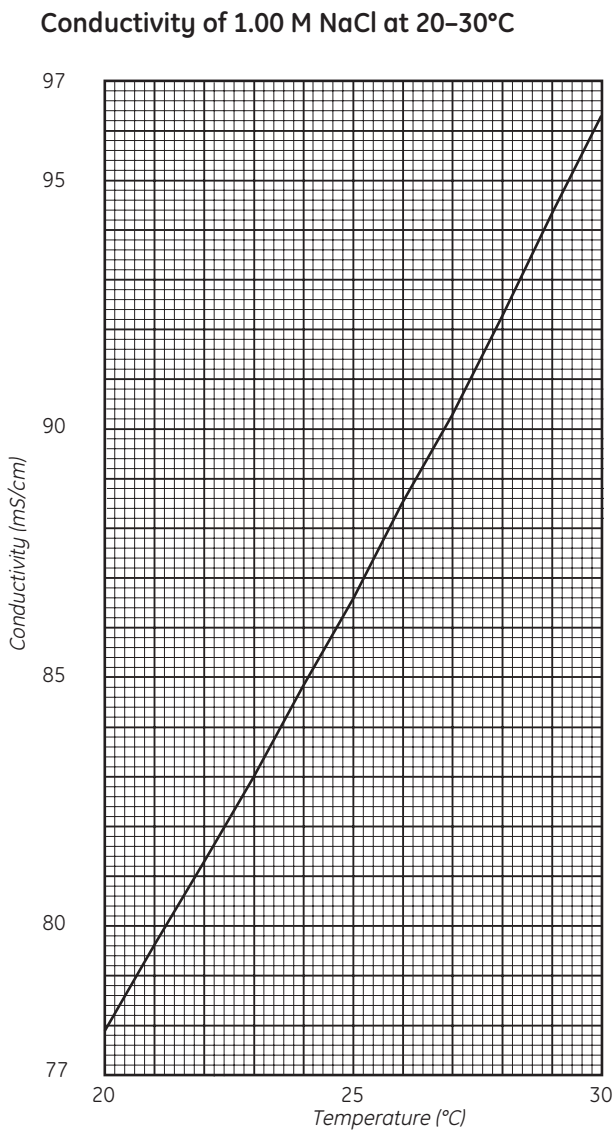

## 7.7.4 Calibrate the UV monitors

### Automatic calibration of the UV monitor U9-M

The wavelength is automatically calibrated every time the instrument is switched on. If the instrument has been switched on for a couple of days, and the ambient temperature and/or the humidity has changed, restart the instrument using the power switch to calibrate the UV monitor.

### Calibration of the UV monitor U9-L flow cell length

The path length in the UV flow cell or the UV 2nd flow cell might differ from the nominal length, which leads to incorrect results in the calculation of protein concentration in the eluate. To achieve normalized absorbance, the path length in the UV flow cell or the UV 2nd flow cell must be calibrated. The calibration procedure that is described below is the same for both UV flow cell and the UV 2nd flow cell, unless otherwise stated.

**Note:** *The flow cell path length must be registered or updated in UNICORN, when the flow cell is replaced.*

### Equipment needed

To perform the calibration, a calibration kit containing test solutions, syringes and accessories is needed. A specified kit is available for each cell length.

If using a UV flow cell with the theoretical path length...	Then use calibration kit...
2 mm	UV-900 2 mm calibration kit (Product Code 18-6324-02)
5 mm	UV-900 5 mm calibration kit (Product Code 18-6324-04)

To calculate the real path length of the UV flow cell, use the following software:

- UV-900 cell calibration Excel-file (Product Code 18-6324-06)

### Prepare for calibration

Follow the instructions below to prepare for the calibration of the UV monitor U9-L.

Step	Action
1	Ensure that the flow restrictor is inline in the flow path after the UV flow cell.
2	Mount the union Luer female/1/16" male, included in the test kit, in the upper inlet of the UV flow cell.
3	Open the software <b>UV-900 cell calibration</b> Excel-file.



Step	Action
4	The solution bottles are labelled with the concentration value and the reference absorbance value for each solution. Enter the concentrations of the solutions in ascending order into the column <b>UV Test kit Concentration (mg/l)</b> . Enter the corresponding absorbance values into the column <b>UV Test kit Absorbance (AU/cm)</b> .

## Perform the calibration

Follow the instructions below to calibrate UV monitor U9-L and UV monitor U9-L, 2nd.

Step	Action
1	In the <b>System Control</b> module, select <b>Manual:Execute Manual Instructions</b> .  In the <b>Manual Instructions</b> dialog: <ul style="list-style-type: none"><li>• Select <b>Pumps:System flow</b> and set the <b>Flow rate</b> to 0.0 ml/min.</li><li>• Click <b>Execute</b>.</li></ul> <i>Result:</i> The absorbance can now be monitored.
2	Fill one of the supplied syringes with 1.5-2 ml of the first solution (0 mg/l). Ensure that there are no air bubbles in the syringe.
3	Fit the syringe in the union Luer connector and inject the solution. DO NOT remove the syringe.

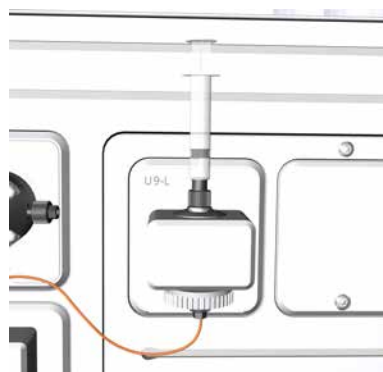

**Note:**

*Air trapped in the UV cell causes inaccurate measurements. To avoid introducing air into the UV cell, gently fill the union Luer up to the edge with test solution that is to be introduced, using the syringe. Then insert the syringe into the union Luer.*

4	Wait until the monitored absorbance value has stabilized.
---	---

Step	Action
5	<p>In the <b>Manual Instructions</b> dialog:</p> <p>For UV monitor U9-L:</p> <ul style="list-style-type: none"><li>• Select <b>Monitors:Auto zero UV</b></li><li>• Click <b>Execute</b>.</li></ul> <p>For UV monitor U9-L, 2nd:</p> <ul style="list-style-type: none"><li>• Select <b>Monitors:Auto zero UV 2nd</b></li><li>• Click <b>Execute</b>.</li></ul> <p><i>Result:</i> The UV absorbance is set to zero.</p>
6	Remove the syringe.
7	Repeat the injections with the remaining four test solutions in increasing concentration order. Use a new syringe for each solution.
8	After each injection, wait for a stable absorbance value. Note the measured absorbance values for each solution.
9	<p>Enter the measured absorbance values into the table in the column <b>UV-900 Absorbance (AU)</b>.</p> <p><b>Note:</b> <i>The values should be converted from mAU to AU.</i></p>
10	<p>When all absorbance values have been entered into the table, the real UV flow cell path length is shown at the bottom of the table.</p> <p><b>Note:</b> <i>The regression coefficient R2 should be larger than 0.999. If this is not the case, one or more measured values are faulty.</i></p>

## Update the cell path length

Follow the instructions below to define the **UV cell path length** or the **UV 2nd cell path length**. The flow cell path length should be updated when the flow cell has been replaced or calibrated.

Step	Action
1	In the <b>System Control</b> module, select <b>System:Calibration</b> .
2	<p>In the <b>Calibration</b> dialog, select</p> <ul style="list-style-type: none"><li>• <b>UV cell path length</b></li></ul> <p>or</p> <ul style="list-style-type: none"><li>• <b>UV 2nd cell path length</b></li></ul> <p>from the <b>Monitor to calibrate</b> drop-down list.</p>
3	Enter the nominal flow cell path length in the <b>Nominal length</b> input field and click <b>Set</b> .

Step	Action
4	<ul style="list-style-type: none"><li data-bbox="467 300 1493 363">• If a calibration has been performed: enter the calculated flow cell path length, obtained in the calibration procedure, in the <b>Real length</b> input field and click <b>Set</b>.</li><li data-bbox="467 385 1493 455">• If no calibration has been performed: enter the nominal flow cell path length in the <b>Real length</b> input field and click <b>Set</b>.</li></ul> <p data-bbox="467 470 1015 500"><i>Result:</i> The UV flow cell path length is updated.</p>

## 7.8 Replacement procedures

### Introduction

This section gives instructions for the replacement procedures to be performed by the user of ÄKTA pure.



#### **WARNING**

**Disconnect power.** Always disconnect power from the instrument before replacing any component on the instrument, unless stated otherwise in the user documentation.

### In this section

This section contains the following subsections:

<b>Section</b>	<b>See page</b>
7.8.1 Replace tubing and connectors	317
7.8.2 Replace internal tubing in Fraction collector F9-C	319
7.8.3 Replace the Mixer	322
7.8.4 Replace the O-ring inside the Mixer	323
7.8.5 Replace the UV monitor U9-M flow cell	325
7.8.6 Replace the UV monitor U9-L flow cell	328
7.8.7 Replace Flow restrictor	330
7.8.8 Replace the inlet filters	331
7.8.9 Replace the pump head check valves	332
7.8.10 Replace pump piston seals of Pump P9 or P9H	335
7.8.11 Replace pump piston seals of Pump P9-S	344
7.8.12 Replace pump pistons	351
7.8.13 Replace pump rinsing system tubing	352

## 7.8.1 Replace tubing and connectors

### Maintenance interval

Replace tubing and connectors when required, for example when a tubing has clogged or has been bent so that the flow is stopped.

---

### Required material

The following material are required:

- Tubing and connectors
  - Tubing cutter
  - Fingertight wrench
- 

### Instruction

Follow the instruction below to replace tubing and connectors.

Step	Action
1	Make sure that no run is in progress on the instrument.
2	Unscrew the connectors, and disconnect the tubing.
3	If the tubing has labels, remove the labels to be used with the new tubing later. Discard the tubing and connectors.

Step	Action
4	Cut the new tubing to the same length as the old tubing. Use a tubing cutter to get a straight angle cut.

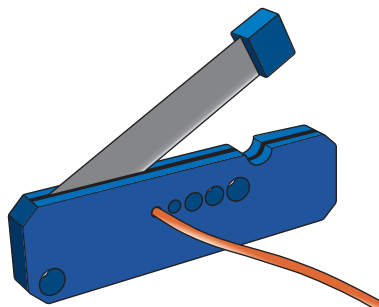

**CAUTION**

**Cut injuries.** The tubing cutter is very sharp and must be handled with care to avoid injuries.

**Note:**

*When replacing system tubing, use the original inner diameter and length to ensure that the correct delay volumes are maintained. Inlet and outlet tubing may be shortened if required.*

5	Put the old labels on the new tubing.
6	Mount the connectors on the tubing. For fingertight connectors: <ul style="list-style-type: none"><li>• Slide the connector onto the tubing.</li></ul> For tubing connectors 1/8": <ul style="list-style-type: none"><li>• Slide the connector onto the tubing.</li><li>• Slide the ferrule onto the tubing with the thick end towards the end of the tubing.</li></ul>
7	Insert the tubing with connector into the port. Make sure to insert the tubing all the way into the bottom of the port.
8	Tighten the connector fully. For areas difficult to access, use the fingertight wrench included in the accessory kit.

## 7.8.2 Replace internal tubing in Fraction collector F9-C

### Maintenance interval

Replace tubing and connectors when required, for example when the tubing has clogged or has been bent so that the flow is stopped.

---

### Required material

The following material are required:

- Tubing and connectors
  - Tubing cutter
  - Fingertight wrench
- 

### Instructions

Follow the instructions below to replace tubing and connectors. See [Section 3.2.2 Fraction collector F9-C illustrations, on page 92](#) for the locations of the components of the fraction collector.

Step	Action
1	Switch off the power to the fraction collector by switching off power to the ÄKTA pure instrument.
2	Remove the connector for the internal tubing that is attached to the inlet port: <ul style="list-style-type: none"><li>• Unscrew the connector from the inlet port.</li></ul>

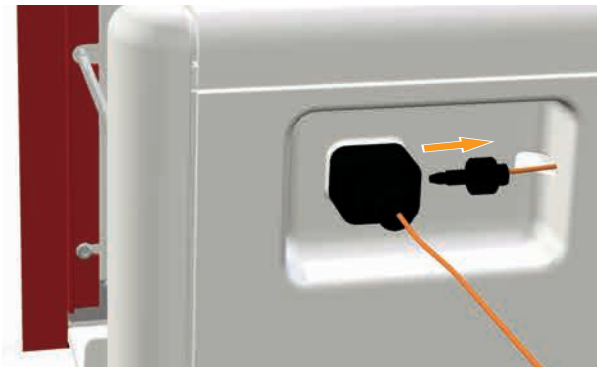

- Remove the connector from the tubing.

Step	Action
------	--------

3	Remove the tubing connector from the dispenser head:
---	--

- Open the fraction collector and gently move the fractionation arm forward.
- Unscrew the connector from the dispenser head and remove the tubing.

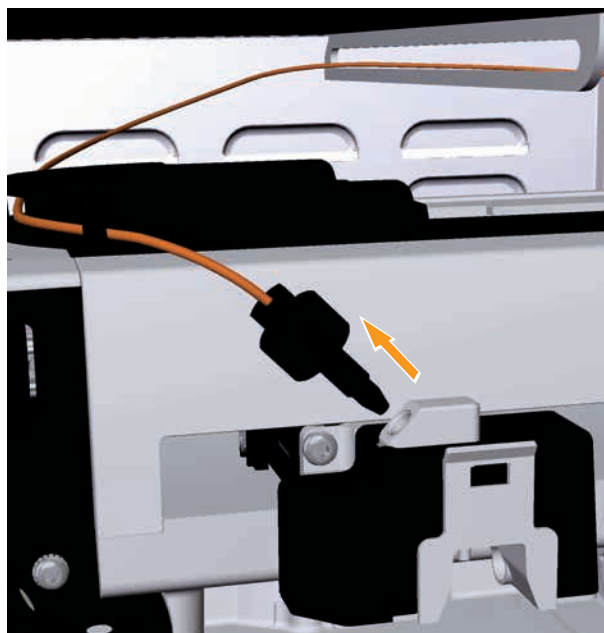

- Gently move the fractionation arm all the way back.

4	Cut the new tubing to the same length as the old tubing. Use a tubing cutter to get a straight angle cut.
---	---

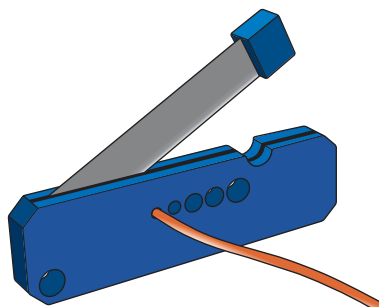

**CAUTION**

**Cut injuries.** The tubing cutter is very sharp and must be handled with care to avoid injuries.

**Note:**

*Use tubing with the original inner diameter and length to ensure that the correct delay volume is maintained.*



Step	Action
5	<p>Attach the new tubing to the inlet port:</p> <ul style="list-style-type: none"><li>• Thread the tubing from the interior of the fraction collector to the inlet port.</li><li>• Slide the fingertight connector onto the tubing.</li><li>• Insert the tubing with connector into the port. Make sure to insert the tubing all the way into the bottom of the port.</li><li>• Tighten the connector fully.</li></ul>
6	<p>Thread the tubing into the fraction collector and through the tubing guide in the ceiling of the fractionation chamber.</p>
7	<p>Position the new tubing:</p> <ul style="list-style-type: none"><li>• Gently move the fractionation arm forward while holding the tubing.</li><li>• Thread the tubing through the second tubing guide.</li></ul> 
8	<p>Attach the new tubing to the dispenser head:</p> <ul style="list-style-type: none"><li>• Slide the fingertight connector onto the tubing.</li><li>• Insert the tubing with connector into the port. Make sure to insert the tubing all the way into the bottom of the port.</li><li>• Tighten the connector fully.</li></ul>
9	<p>Make sure that the tubing not is twisted or bent and that it does not dip downwards.</p>

## 7.8.3 Replace the Mixer

### Maintenance interval

Replace the Mixer when a different Mixer chamber is desired, or when the Mixer is damaged.

---

### Required material

The following is required:

- Mixer
- 

### Instruction

Follow the instruction below to change the Mixer.

Step	Action
1	Disconnect the tubing from the top and bottom of the Mixer.



2	Pull the Mixer away from the instrument.
---	--



3	Attach the new Mixer.
4	Reconnect the tubing to the top and bottom of the new Mixer.

---

## 7.8.4 Replace the O-ring inside the Mixer

### Maintenance interval

Replace the O-ring inside the Mixer if it is damaged.

### Required material

One of the following O-rings are required:

- O-ring 13.1 × 1.6 mm (for Mixer chambers 0.6, 1.4, and 5 ml)
- O-ring 13.1 × 1.6 mm (highly resistant, for use when the system is exposed to organic solvents or high concentrations of organic acids such as acetic acid or formic acid for longer periods of time).
- O-ring 22.1 × 1.6 mm (for Mixer chamber 15 ml)

### Instruction

Follow the instruction below to replace the O-ring inside the Mixer.

**Tip:** Use a forceps and gloves during the replacement procedure to avoid contaminating the Mixer components.

Step	Action
1	Loosen the top section of the Mixer.
2	Unscrew the top section of the Mixer and pull apart the Mixer in two halves.



- 3 Remove the outer locking O-ring from the top section.



## 7 Maintenance

### 7.8 Replacement procedures

#### 7.8.4 Replace the O-ring inside the Mixer

Step	Action
4	Lift up the top section of the Mixer and pull away the old O-ring inside. 
5	Wet the new O-ring with 20% ethanol and fit it in position. Make sure that the inline filter is still in position.
6	Reassemble the Mixer components and, while holding the Mixer upright, screw the top section back onto the Mixer.

## 7.8.5 Replace the UV monitor U9-M flow cell

### Maintenance interval

Replace the UV flow cell when it is desired to use a flow cell with a different path length, or if the cell is damaged. Clean the optical fiber connectors if they have accidentally been touched.

### Required materials

The following materials are required:

#### For replacement of flow cell

- UV flow cell

#### For cleaning of the optical fiber connectors

- Lens paper
- Isopropanol

### Replace the flow cell



#### CAUTION

**Hazardous chemicals or biological agents in UV flow cell.** Make sure that the entire flow cell has been flushed thoroughly with bacteriostatic solution (e.g., NaOH) and distilled water, before service and maintenance.

Follow the instruction to replace the UV flow cell.

Step	Action
1	Switch off the instrument.
2	Disconnect the tubing from the UV flow cell.
3	Push the latch on the UV detector to disconnect the detector.



#### Note:

*While the UV detector is disconnected, the UV lamp becomes inoperable so no UV light can be emitted from the instrument.*

Step	Action
4	Pull off the detector and the flow cell from the monochromator. Be careful not to damage the UV flow cell.

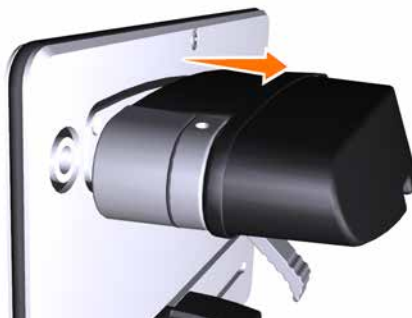

**Note:**

Make sure that the flow cell does not come into contact with any liquid, and that no liquid enters the UV detector or monochromator.

**Note:**

While the UV detector is disconnected, protect the fiber connectors from dust or other impurities by mounting the rubber protective caps onto them.

**Note:**

Do not touch the optical fiber connectors as this will result in poor monitor performance. If you accidentally touch the optical fiber connectors, clean them according to [Clean the optical fiber connectors, on page 327](#).

5	Pull off the UV flow cell from the detector.
6	Pull off the black protective caps from the new UV flow cell, and connect the new UV flow cell to the detector.
7	Connect the detector, with the new flow cell connected, to the monochromator. Pull the latch upwards to fasten the detector.
8	Connect the tubing to the new flow cell.
9	Switch on the instrument. <i>Result:</i> The flow cell path length is automatically recognized by the monitor when a new flow cell is connected.

## Clean the optical fiber connectors

Follow the instruction to clean the optical fiber connectors.



### WARNING

**Hazardous substances.** When using hazardous chemicals, take all suitable protective measures, such as wearing protective clothing, glasses and gloves resistant to the substances used. Follow local and/or national regulations for safe operation and maintenance of the product.

Step	Action
1	Wipe the optical fiber connectors with isopropanol on lens paper.
2	Wipe the optical fiber connectors dry with lens paper.

## 7.8.6 Replace the UV monitor U9-L flow cell

### Maintenance interval

Replace the UV flow cell when it is desired to use a flow cell with a different path length, or if the cell is damaged.

### Required material

- UV flow cell

### Replace the flow cell



#### CAUTION

**Hazardous chemicals or biological agents in UV flow cell.** Make sure that the entire flow cell has been flushed thoroughly with bacteriostatic solution (e.g., NaOH) and distilled water, before service and maintenance.

Follow the instruction below to replace the UV flow cell.

Step	Action
1	Switch off the instrument.
2	Disconnect the tubing from the UV flow cell.
3	Unscrew the knurled wheel at the bottom of the UV monitor (1). Press the wheel upwards to release the flow cell (2).

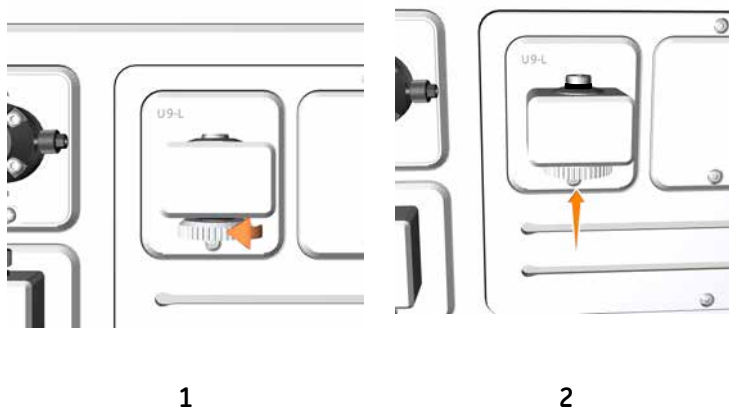



Step	Action
4	Pull the flow cell upwards out of the monitor. Hold the flow cell by the top part with the O-ring: do not touch the optical surfaces of the flow cell.



**Note:**

*Make sure that the flow cell does not come into contact with any liquid, and that no liquid enters the monitor.*

5	Insert a new flow cell into the monitor.
6	Tighten the knurled wheel firmly.
7	Connect the tubing to the new flow cell.
8	Switch on the instrument and log on to UNICORN.
9	Update the UV flow cell path length in the <b>Calibrate</b> dialog, in <b>System Control</b> .

**Note:**

*The flow path cell length can be:*

- *updated with the nominal value, see [Update the cell path length](#), on page 314 to set the nominal flow cell path length*  
*or*
- *calibrated and updated with the calculated value, see [Calibration of the UV monitor U9-L flow cell length](#), on page 312 to calibrate the flow cell path length and to update the software with the calculated value.*

## 7.8.7 Replace Flow restrictor

### Maintenance interval

Replace the Flow restrictor when required, for example when the back pressure of the Flow restrictor is outside the range  $0.2 \pm 0.05$  MPa.

---

### Required material

The following material is required:

- Flow restrictor **FR-902**
- 

### Instruction

Follow the instruction to replace the Flow restrictor.

Step	Action
1	Disconnect the tubing connected from the used Flow restrictor, and discard the used Flow restrictor.
2	Connect the tubing to the new Flow restrictor. Make sure that the Flow restrictor connector marked <b>IN</b> is connected to the pH valve port <b>ToR</b> (To Restrictor), and that the Flow restrictor connector marked <b>OUT</b> is connected to the pH valve port <b>FrR</b> (From Restrictor).
3	Check the back-pressure of the new Flow restrictor, see <a href="#">Section 7.4 Monthly maintenance, on page 269</a> .

---

## 7.8.8 Replace the inlet filters

### Maintenance interval

Replace the inlet filter when required, for example when the filters are clogged.

---

### Required materials

The following material is required:

- Inlet filter set
- 

### Instruction

Follow the instruction to replace an inlet filter and a support net.

Step	Action
1	Pull off the inlet filter and the support net from the inlet filter holder.



2	Fit the new support net and inlet filter, and press the filter into position.
---	---

---

## 7.8.9 Replace the pump head check valves

### Maintenance interval

Replace a check valve when required, for example if the check valve is damaged or clogged. The following instructions are valid for the system pumps and the sample pump.

### Required materials

The following materials are required:

- Check valve kit
- Adjustable wrench

### Instruction



#### NOTICE

Handle the check valves with care when they have been removed from the pump heads, to prevent loss of any internal components.

Follow the instruction to replace the check valves of a pump.

Step	Action
1	Disconnect the tubing from the pump head and disconnect the pump inlet tubing.
2	Unscrew the purge valve by turning it counter-clockwise, and lift off the metal ring.

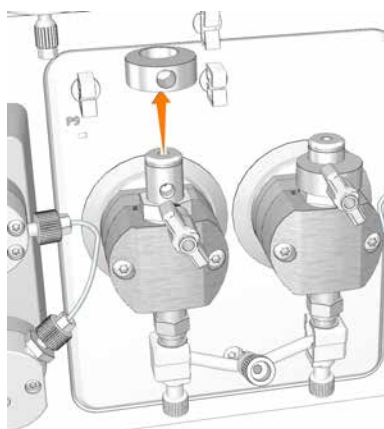

- | Step | Action  |
|------|---|
| 3    | Unscrew the plastic nut of the upper check valve using an adjustable wrench, and gently lift off the upper check valve. |

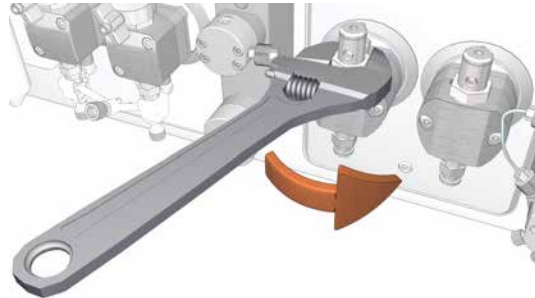

- |   |  |
|---|--|
| 4 | Replace the upper check valve with a new one.  |
| 5 | Tighten the nut until fully finger-tight and then use the adjustable wrench to tighten a further 180 degrees.                              |
| 6 | Place the new metal ring onto the new upper check valve, and screw the new purge valve.  |
| 7 | Unscrew the two white plastic screws located below each pump head. Pull the plastic connectors to the sides to release the inlet manifold. |

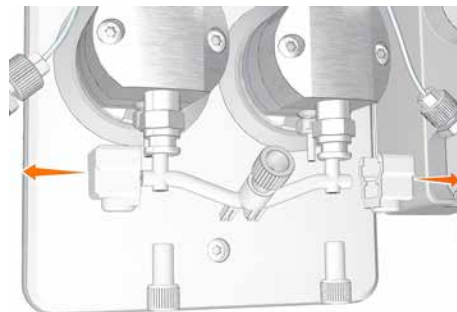

- |   |   |
|---|---|
| 8 | Unscrew the lower check valve using an adjustable wrench. |
|---|---|

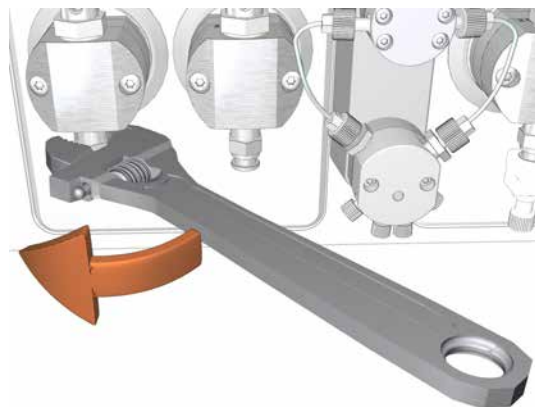

## 7 Maintenance

### 7.8 Replacement procedures

#### 7.8.9 Replace the pump head check valves

<b>Step</b>	<b>Action</b>
9	Replace the lower check valve with a new one.
10	Tighten the nut until fully finger-tight and then use the adjustable wrench to tighten a further 180 degrees.
11	Refit the inlet manifold and reconnect the tubing to the pump head.

## 7.8.10 Replace pump piston seals of Pump P9 or P9H

### Maintenance interval

Replace the O-rings and piston seals and rinse the membranes of the pumps if they are damaged. After replacement, perform a run to break in the new piston seals.

The instructions in this section apply to the following pumps.

Configuration	Label	Pump type
System pump A, ÄKTA pure 25	<b>P9 A</b>	P9
System pump B, ÄKTA pure 25	<b>P9 B</b>	P9
System pump A, ÄKTA pure 150	<b>P9H A</b>	P9H
System pump B, ÄKTA pure 150	<b>P9H B</b>	P9H
Sample pump <b>S9H</b> , ÄKTA pure 150	<b>P9H S</b>	P9H



#### NOTICE

**Advanced maintenance.** Read the instruction carefully before disassembly of the pump head.

### Required material

The following materials are required:

- Adjustable wrench
- For Pump **P9**: Star screwdriver, T20
- For Pump **P9H**: Star screwdriver, T10 and T20
- Ultrasonic bath
- Ethanol, 20%
- For Pump **P9**: Tubing giving a back pressure of 6 to 8 MPa (60 to 80 bar).
- For Pump **P9H**: Tubing giving a back pressure of 2 to 3 MPa (20 to 30 bar)
- For Pump **P9**: P9 Seal kit, 25 ml
- For Pump **P9H**: P9H Seal kit, 150 ml

## Illustrations

The illustrations below show the parts of the pump heads of the pumps **P9** and **P9H**.

### Pump P9

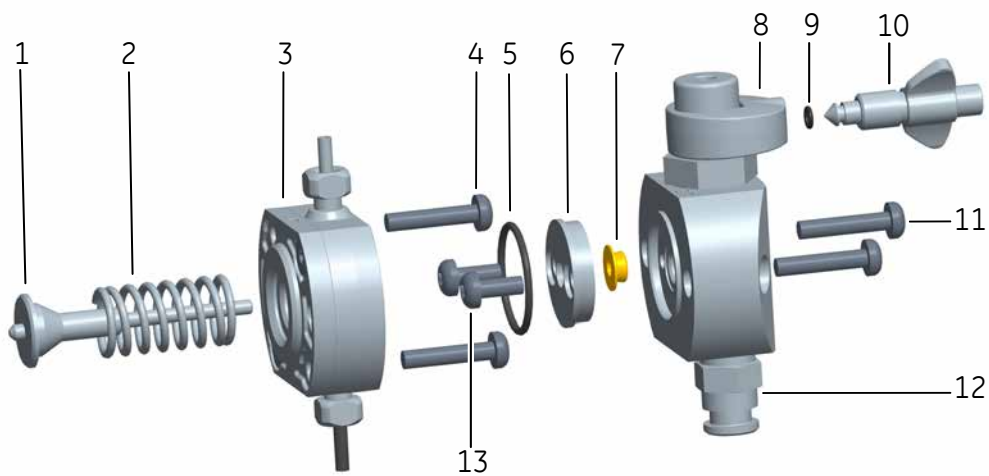

### Pump P9H

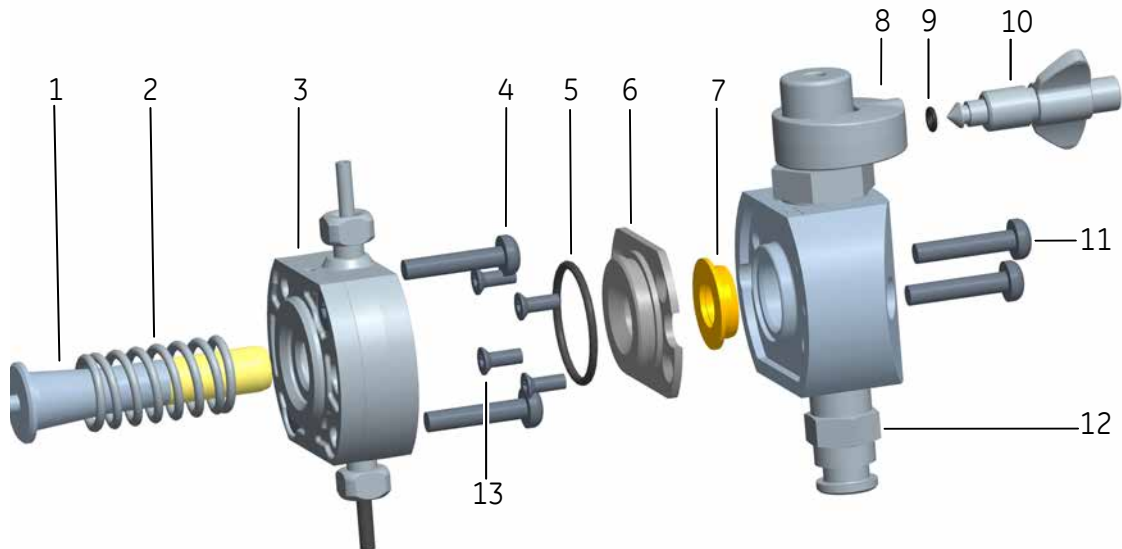



Part	Description	Part	Description
1	Piston	7	Piston seal
2	Return spring	8	Outlet check valve
3	Pump membrane housing	9	O-ring
4	Star screws	10	Purge valve
5	O-ring	11	Star screws
6	Support washer	12	Inlet check valve
13	Star screws		

## Introduction

Follow the instructions below to replace the O-rings, piston seal, and pump membrane housing of pumps **P9** and **P9H**.

**Note:** Always replace the O-rings, piston seals, and pump membrane housing of both pump heads of a pump at the same time.

## Disassemble the pump head

- | Step | Action   |
|------|--|
| 1    | Make sure that no run is in progress on the instrument.  |
| 2    | Disconnect the tubing from the pump head, and disconnect the pump inlet tubing.  |
| 3    | Unscrew the two white plastic screws located below each pump head by hand. Pull the plastic connectors to the sides to release the inlet manifold. |

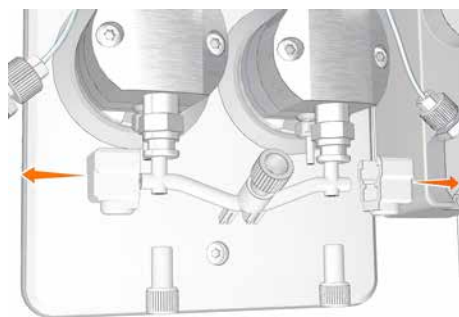

- |   |  |
|---|--|
| 4 | Disconnect the tubing of the pump piston rinsing system. |
|---|--|

- | Step | Action   |
|------|--|
| 5    | Unscrew the two screws of the front section of the pump head using a star screwdriver T20, and pull off the front section. |

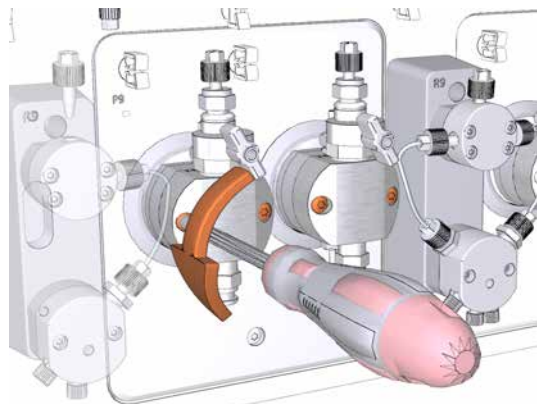

- |   |   |
|---|---|
| 6 | Place the front section of the pump head face down on the bench. For Pump <b>P9</b> , unscrew the two screws of the support washer using a star screwdriver, T20. For Pump <b>P9H</b> , unscrew the four screws of the support washer using a star screwdriver, T10. Discard the O-ring (1) on the support washer, and discard the piston seal (2) located in the front section of the pump head. |
|---|---|

**Note:**

*Be careful not to scratch the metal surfaces.*

**Pump P9**

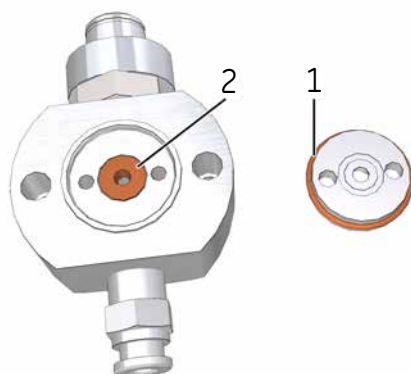

**Pump P9H**

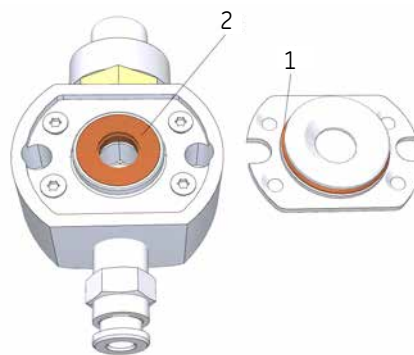

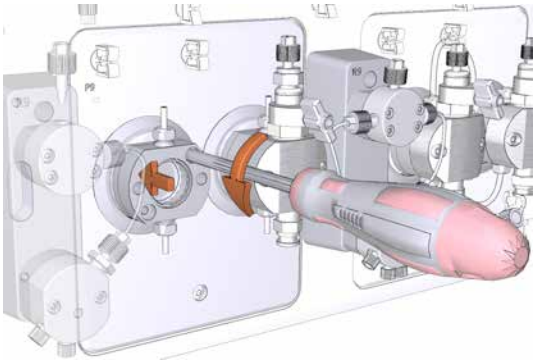
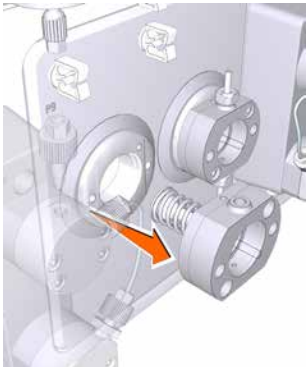
Step	Action
7	Unscrew <i>one</i> of the two screws securing the pump membrane housing using a star screwdriver, T20. Unscrew the second screw, and at the same time push firmly on the front of the pump membrane housing to compensate for the pressure of the piston return spring.
 A 3D technical illustration of a pump assembly. A red-handled star screwdriver is shown inserted into one of the two screws that secure the pump membrane housing. The housing is a grey, rectangular component with various ports and a central opening. The screwdriver is positioned to turn the screw counter-clockwise.	
8	Carefully pull off the pump membrane housing together with the piston and return spring.
 A 3D technical illustration showing the pump membrane housing being pulled away from the main pump body. An orange arrow points from the housing towards the viewer, indicating the direction of removal. The housing is shown as a separate component, revealing the internal piston and return spring mechanism.	
9	Inspect the piston and return spring for signs of damage. If damaged, discard the piston and return spring and use a new piston and return spring when assembling the pump head.
10	Clean the pump head and pump membrane housing in an ultrasonic bath. If there are particles on any surfaces, the check valves should be removed and cleaned separately, see <a href="#">Section 7.6.8 Clean the pump head check valves, on page 296</a> .

## Replace O-rings, piston seal and pump membrane housing

Step	Action
1	Unscrew the purge valve of the pump head. Replace the O-ring on the purge valve with a new O-ring, and screw the purge valve back into the pump head.

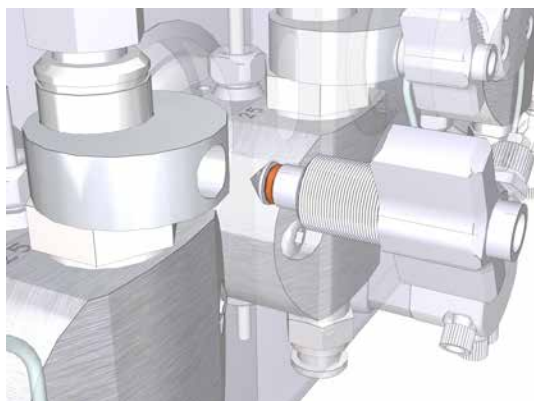

**Note:**

Always use Lubricant 56686700 when exchanging the O-ring 3 x 1 mm.

2	Wet a new seal with 20% ethanol. Place the new seal in the hole in the front section of the pump head and press it into position.
---	---

Pump P9

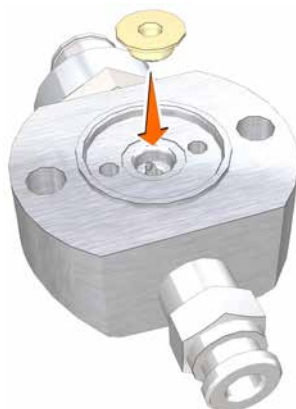

Pump P9H

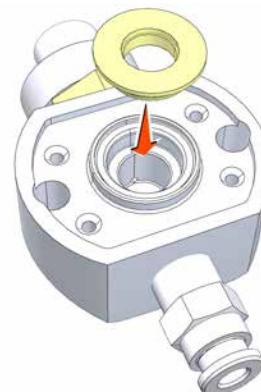

Step	Action
3	Place the support washer on top of the new seal in the front section of the pump head. Screw the two or four screws of the support washer. Make sure to tighten the screws fully.

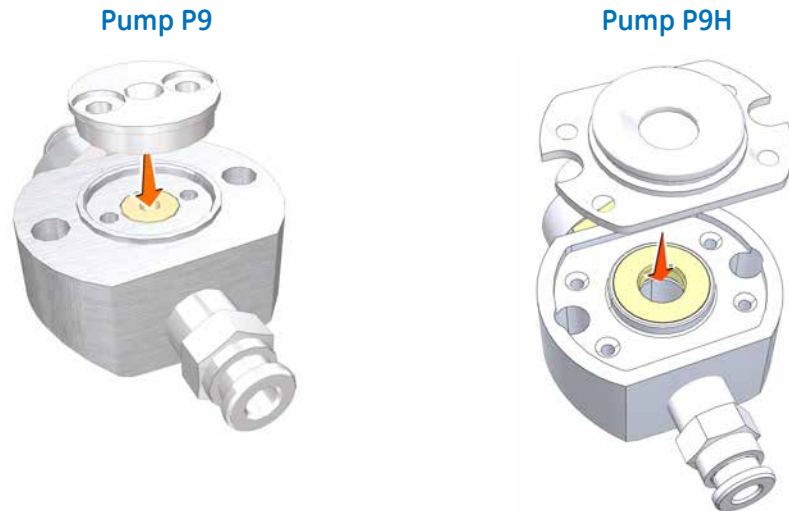

4	Wet a new O-ring, 21.4 x 1.6 mm, with 20% ethanol. Fit the O-ring around the support washer.
---	--

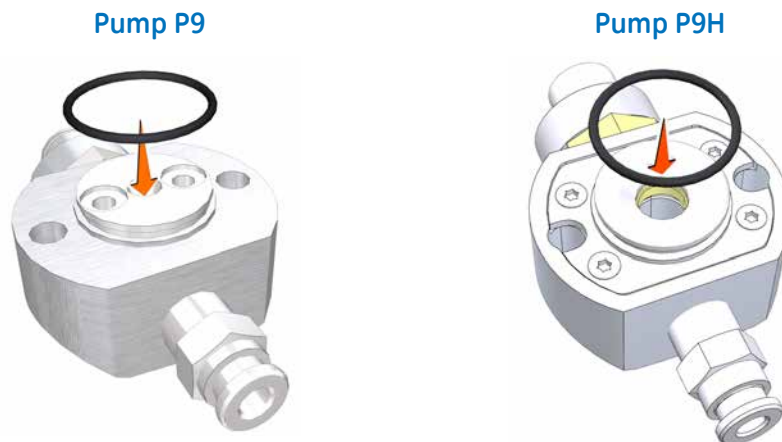

## Assemble the pump head

Make sure to assemble the pump head correctly. Refer to [Illustrations, on page 336](#).

Step	Action
1	Insert the piston into the return spring. Insert piston and return spring into hole in the pump module.  <b>Note:</b> <i>Do no touch the ceramic or glass part of the pump piston.</i>
2	Wet the membrane in the hole with 20% ethanol before mounting.
3	Place the pump membrane housing onto the locating pins on the front of the pump module.
4	Screw one of the two screws securing the pump membrane housing using a star screwdriver, T20. Push firmly on the front of the pump membrane housing to compensate for the pressure of the piston and then screw the second screw.
5	Make sure that the new seal is wetted with 20% ethanol and then tighten both screws fully.
6	Reconnect the tubing of the pump piston rinsing system.
7	Reconnect the inlet manifold.
8	Reconnect the tubing to the pump head, and reconnect the pump inlet tubing.

## Break in the new pump piston seal

Follow the instruction below to run in the new pump piston seal of pumps P9 and P9H.

Step	Action
1	Fill a buffer vessel with 20% ethanol in water. Immerse the inlet tubing, for example <b>A1</b> for System pump A, or <b>B1</b> for System pump B, in the buffer vessel. Place the buffer vessel on the Buffer tray.
2	Prime the inlets and purge the pump, see <a href="#">Section 5.4.1 System pumps, on page 161</a> .
3	<ul style="list-style-type: none"> <li>For pump P9: Connect tubing that gives a back pressure of 6 to 8 MPa to one of the column positions of the Column valve or between the Injection valve and the UV monitor.</li> <li>For pump P9H: Connect tubing that gives a back pressure of 2 to 3 MPa to one of the column positions of the Column valve or between the Injection valve and the UV monitor.</li> </ul>
3	Immerse the waste tubing in the buffer vessel to recirculate the liquid.

Step	Action
4	<ul style="list-style-type: none"><li>For a system pump, in the <b>Manual instructions</b> dialog:<ul style="list-style-type: none"><li>Select <b>Flow path:Column valve</b>, and select the position of the tubing connected to the Column valve, in this example <b>Position 1</b>. Click <b>Insert</b>.</li><li>Select <b>Flow path:Inlet A</b> (for System pump A) or <b>Flow path:Inlet B</b> (for System pump B) and select a <b>Position</b>, in this example <b>A1</b> or <b>B1</b>. Click <b>Insert</b>.</li><li>Select <b>Pumps:Gradient</b> and set <b>Target</b> to 0% B (for System pump A) or 100% B (for System pump B).</li><li>For pump P9: Select <b>Pumps:System flow</b> and set the <b>Flow rate</b> to 5.0 ml/min. Click <b>Insert</b>.</li><li>For pump P9H: Select <b>Pumps:System flow</b> and set the <b>Flow rate</b> to 25.0 ml/min. Click <b>Insert</b>.</li><li>Click <b>Execute</b>.</li></ul><p><i>Result:</i> A system flow starts.</p></li><li>For a sample pump, in the <b>Manual instructions</b> dialog:<ul style="list-style-type: none"><li>Select <b>Flow path:Column valve</b>, and select the position of the tubing connected to the Column valve, in this example <b>Position 1</b>. Click <b>Insert</b>.</li><li>Select <b>Flow path:Sample inlet</b> and select a <b>Position</b>, in this example <b>S1</b>. Click <b>Insert</b>.</li><li>Select <b>Flow path:Injection valve</b> and select <b>Direct inject</b> from the <b>Position</b> drop-down list. Click <b>Insert</b>.</li><li>Select <b>Pumps and Pressures:Sample flow</b> and set the <b>Flow rate</b> to 25.0 ml/min. Click <b>Insert</b>.</li><li>Click <b>Execute</b>.</li></ul><p><i>Result:</i> A sample flow starts.</p></li></ul>
5	Run the flow for 2 hours.
6	Discard the used buffer.

## 7.8.11 Replace pump piston seals of Pump P9-S

### Maintenance interval

Replace the O-ring and the piston seal, and rinse the membrane of the pump if they are damaged. After replacement, perform a run to break in the new piston seals.

The instructions in this section apply to the following pump.

Configuration	Label	Pump type
Sample pump <b>S9</b> , ÄKTA pure 150	<b>P9-S</b>	P9-S



#### NOTICE

**Advanced maintenance.** Read the instruction carefully before disassembly of the pump head.

### Required material

The following materials are required:

- Adjustable wrench
- Star screwdriver, T20
- Cross-headed screwdriver
- Hex wrench
- Ultrasonic bath
- Ethanol, 20%
- Reference capillary **Ref 1**
- P9-S Seal kit, 65 ml



## Illustration

The illustration below shows the parts of the pump heads of Pump **P9-S**.

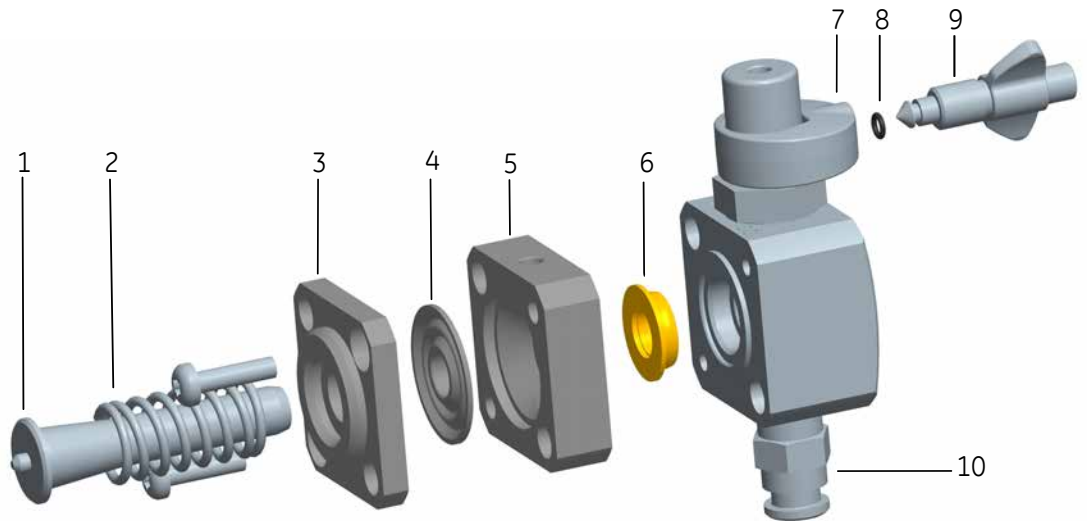

Part	Description	Part	Description
1	Piston	6	Piston seal
2	Return spring	7	Outlet check valve
3	Drain plate	8	O-ring
4	Rinse membrane	9	Purge valve
5	Rinse chamber	10	Inlet check valve

## Introduction

Follow the instructions below to replace the o-ring, piston seal, and rinse membrane of pump P9-S.

**Note:** Always replace the o-rings, piston seals, and rinse membranes of both pump heads of a pump at the same time.

## Disassemble the pump head

Step	Action
1	Make sure that no run is in progress on the instrument.
2	Disconnect the tubing from the pump head, and disconnect the pump inlet tubing.

- | Step | Action   |
|------|--|
| 3    | Unscrew the two white plastic screws located below each pump head by hand. Pull the plastic connectors to the sides to release the inlet manifold. |

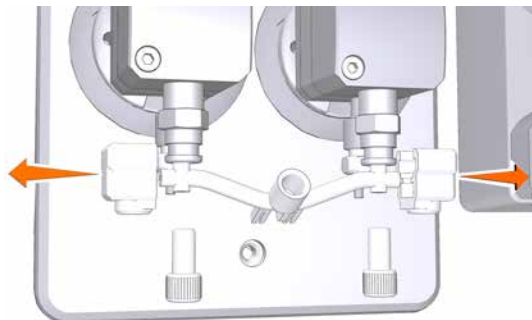

- |   |  |
|---|--|
| 4 | Disconnect the tubing of the pump piston rinsing system.   |
| 5 | Unscrew <i>one</i> of the two screws of the pump head using a hex wrench. Unscrew the second screw, and at the same time push firmly on the front of the rinse chamber to compensate for the pressure of the piston return spring. |

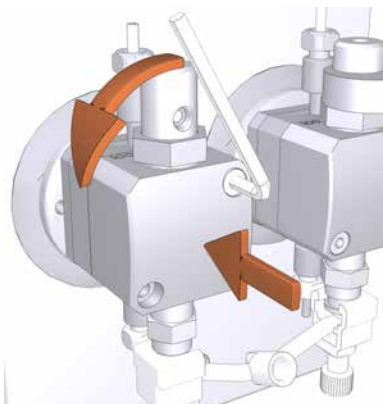

- |   |  |
|---|--|
| 6 | Place the pump head face down on the bench. Pull out the piston together with the return spring. |
|---|--|

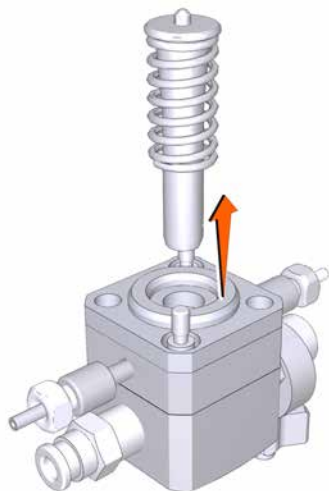

Step	Action
7	Inspect the piston and return spring for sign of damage. If damaged, discard the piston and return spring and use a new piston and return spring when assembling the pump head.
8	Unscrew the two screws securing the drain plate and the rinse chamber. Lift off the drain plate, and discard the membrane located between the drain plate and the rinse chamber.

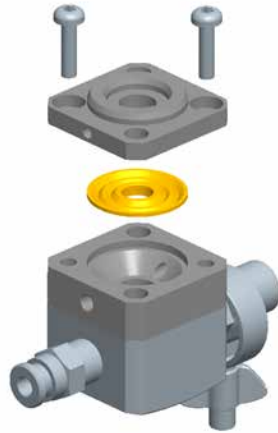

9	Lift off the rinse chamber. Gently pull off the piston seal. Discard the used seal.
---	---

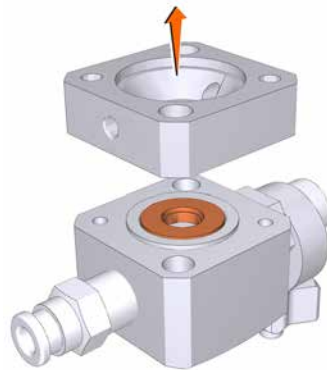

10	Clean the pump head, rinse chamber and drain plate in an ultrasonic bath. If there are particles on any surfaces, the check valves should be removed and cleaned separately, see <a href="#">Section 7.6.8 Clean the pump head check valves, on page 296</a> .
----	--

---

## Replace O-ring, piston seal, and rinse membrane

Step	Action
1	Unscrew the purge valve of the pump head. Replace the O-ring on the purge valve with a new O-ring, 3x1 mm, and screw the purge valve back into the pump head.

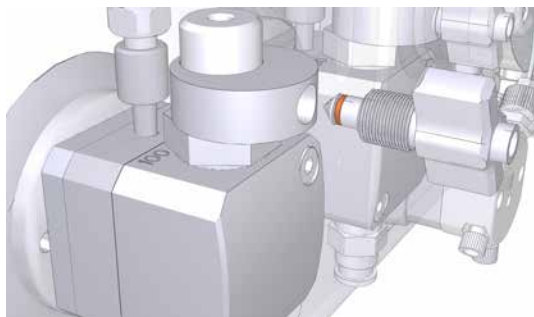
**Note:**

Always use Lubricant 56686700 when exchanging the O-ring 3 x 1 mm.

2	Wet a new seal with 20% ethanol. Place the new seal in the hole in the front section of the pump head and press it into position.
---	---

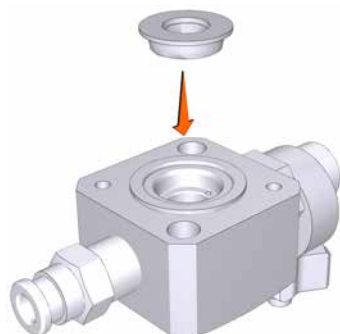

3	With the pump head facing downwards on the bench, place the rinse chamber onto the front section of the pump head with the rinse ports in line with the check valves. The conical depression in the rinse chamber shall be facing upwards. Wet a new membrane with 20% ethanol, and place the membrane into the rinse chamber with the conical face upwards.
---	--



## Assemble the pump head

Make sure to assemble the pump head correctly. Refer to *Illustrations, on page 336*.

Step	Action
1	Place the drain plate on top of the assembly. Screw the two screws through the drain plate and the rinse chamber using a cross-headed screwdriver.
2	Wipe clean the piston and remove all finger prints. Wet the piston with 20% ethanol, and insert the piston into the return spring. With the pump head facing downwards on the bench, insert the piston into the pump head by pushing it gently but firmly vertically downwards into the seal.
3	Place the complete pump head over the locating pins on the front panel of the sample pump module. Turn the pump head so that the text <b>UP</b> on the drain plate is facing upwards. Push firmly on the front of the pump head, and at the same time screw one of the screws to fasten the pump head onto the front of the module using a hex wrench. Screw the second screw of the pump head. Make sure to tighten both screws fully.
4	Reconnect the tubing of the pump piston rinsing system.
5	Reconnect the inlet manifold.
6	Reconnect the tubing to the pump head, and reconnect the pump inlet tubing.
7	Break in the new pump piston seal, see instruction below.

## Break in the new pump piston seal

Follow the instruction below to break in the new pump piston seal of pump P9-S.

Step	Action
1	Fill a buffer vessel with 20% ethanol in water. Immerse a piece of sample inlet tubing, for example <b>S1</b> , in the buffer vessel. Place the buffer vessel on the Buffer tray.
2	Prime the inlets and purge the pump, see <i>Section 5.4.2 Sample pump, on page 167</i>
3	Connect the reference capillary <b>Ref 1</b> (or equivalent tubing that gives a backpressure of 2-3 MPa) to one of the column positions of the Column valve (e.g., ports 1A and 1B).
4	Immerse the waste tubing in the buffer vessel to recirculate the liquid.

## 7 Maintenance

### 7.8 Replacement procedures

#### 7.8.11 Replace pump piston seals of Pump P9-S

Step	Action
5	<p>In the <b>Manual instructions</b> dialog:</p> <ul style="list-style-type: none"><li>• Select <b>Flow path:Column position</b>, and select the <b>Position</b> of the tubing connected to the Column valve, in this example <b>1</b>. Click <b>Insert</b>.</li><li>• Select <b>Flow path:Sample inlet</b> and select a <b>Position</b>, in this example <b>S1</b>. Click <b>Insert</b>.</li><li>• Select <b>Flow path:Injection valve</b> and select <b>Direct inject</b> from the <b>Position</b> drop-down list. Click <b>Insert</b>.</li><li>• Select <b>Pumps:Sample flow</b> and set the <b>Flow rate</b> to 25.0 ml/min. Click <b>Insert</b>.</li><li>• Click <b>Execute</b>.</li></ul> <p><i>Result:</i> A sample flow of 25 ml/min starts.</p>
6	Run the flow for 2 hours.
7	Discard the used buffer.

## 7.8.12 Replace pump pistons

### Maintenance interval

Replace the pump pistons if they are damaged.

---

### Required material

The following materials are required:

- Adjustable wrench
  - Star screwdriver, T20
  - Piston kit
- 

### Replace pump pistons of Pump P9 and P9H

If a damaged piston has been in operation, the piston seal will be destroyed and should also be replaced. To replace the piston and the seal of a system pump, see [Section 7.8.10 Replace pump piston seals of Pump P9 or P9H, on page 335](#).

---

### Replace pump pistons of Pump P9-S

If a damaged piston has been in operation, the piston seal will be destroyed and should also be replaced. To replace the piston and the seal of Pump **P9-S**, see [Section 7.8.11 Replace pump piston seals of Pump P9-S, on page 344](#).

---

## 7.8.13 Replace pump rinsing system tubing

### Maintenance interval

Replace the pump rinsing system tubing when required, for example if the tubing is clogged or damaged. Replacement instructions for the system pumps and the sample pump (external module) are given below.

### Required material

The following material is required:

- Rinsing system tubing

### System pump piston rinsing system

The illustrations below show the parts and tubing of the system pump piston rinsing system

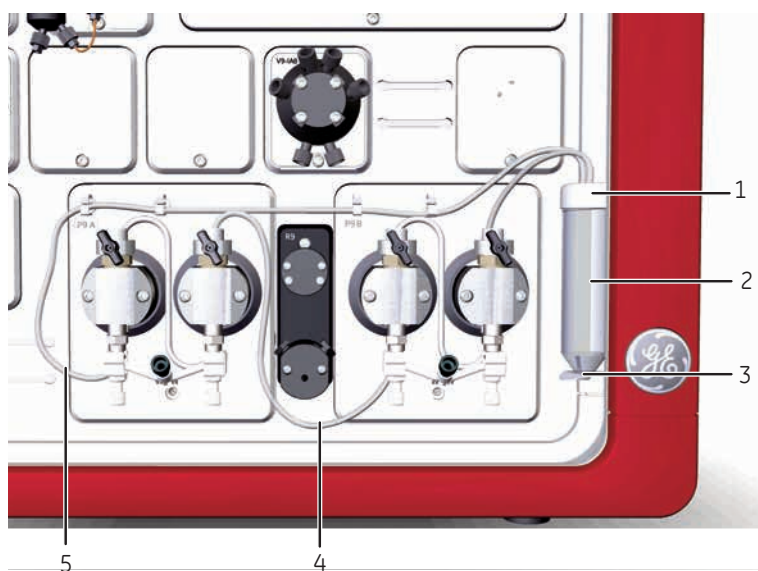

Part	Description
1	Rinsing system tube holder, top
2	Rinsing system tube
3	Rinsing system tube holder, bottom
4	Outlet tubing
5	Inlet tubing



## Sample pump piston rinsing system

The illustrations below show the parts, tubing and flow path of the sample pump piston rinsing system.

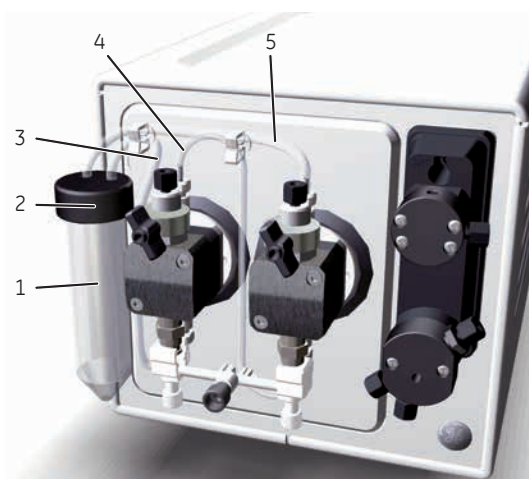

Parts and tubing

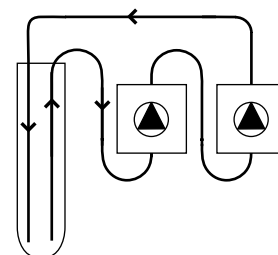

Rinsing system flow path

Part	Function
1	Pump rinsing liquid tube
2	Pump rinsing liquid tube holder
3	Inlet tubing, from the rinsing liquid tube to the left pump head (lower rinsing system connection) .
4	Tubing between the left pump head (upper rinsing system connection) and the right pump head (lower rinsing system connection).
5	Outlet tubing, from the right pump head (upper rinsing system connection) to the rinsing liquid tube.

## Connect new tubing

Step	Action
1	Disconnect the used tubing.
2	Cut the new tubing to desired length.
3	Connect the new tubing according to the illustrations above.
4	Fit all pieces of tubing into the tubing holders on the pump modules.

## 7 Maintenance

### 7.8 Replacement procedures

#### 7.8.13 Replace pump rinsing system tubing

### Prime the rinsing systems

Before usage, prime the pump rinsing system tubing. Refer to [Section 7.3.1 Change pump rinsing solution, on page 262](#) for detailed instructions.

---

# 8 Troubleshooting

## About this chapter

This chapter describes troubleshooting and corrective actions for ÄKTA pure.

---

## In this chapter

This chapter contains the following sections:

Section	See page
8.1 Introduction to troubleshooting	356
8.2 Troubleshooting: General Checklist	358
8.3 Troubleshooting: Monitors	360
8.4 Troubleshooting: Valves	375
8.5 Troubleshooting: Fraction collector	377
8.6 Troubleshooting: Pumps	387
8.7 Troubleshooting: Other components	394
8.8 Troubleshooting: Instrument communication	401
8.9 Troubleshooting: Method development	403
8.10 Error codes	404

---

## 8.1 Introduction to troubleshooting

### Introduction

This section describes troubleshooting procedures for ÄKTA pure and how to generate a System error report for service purposes. Subsequent sections in this chapter present general troubleshooting checklists, module-specific problems and corrective actions.

---

### Troubleshoot the software

For software related troubleshooting, see the following table and the list of literature below:

Problem	Possible cause and action
<b>Text in the <i>Process Picture</i> pane in the <i>System control</i> module looks strange</b>	<b>The operating system of the computer does not have the text font Calibri True Type installed. For example, Windows XP does not include this font by default.</b>  Install the font Calibri True Type or switch to an operating system that includes the font.

- *UNICORN Method Manual*,
  - *UNICORN Evaluation Manual* and
  - *UNICORN Administration and Technical Manual*
- 

### Troubleshooting procedure

To troubleshoot ÄKTA pure:

Step	Action
1	Always start by checking the General checklist. See <a href="#">Section 8.2 Troubleshooting: General Checklist, on page 358</a> .
2	In this document, search for solutions in the section corresponding to the problem.
3	Make the recommended corrective actions.
4	If problems remain after corrective actions, generate a System error report and contact your local GE representative.

---

### Generate a System error report

A System error report can be generated during a troubleshooting case with information about the problem and can also include methods, logs, and results. The report can then be sent to Service for action.

To generate a System error report for information to Service:

Step	Action
1	In the <b>System Control</b> module, on the <b>System</b> menu, click <b>Create System Error Report</b> . <i>Result:</i> The first page of a wizard is displayed.
2	<ul style="list-style-type: none"><li>• Click <b>Next</b> and start to enter information about the problem, click <b>Next</b>.</li><li>• Choose to enclose methods, logs or result files.</li><li>• Select location for the report and click <b>Finish</b> to generate the report. The filename of the zip file will be <code>Report_YYYYMMDD.zip</code> and the default folder location is: <code>C:\Program Files\GE Healthcare\UNICORN</code>.</li></ul>
3	E-mail the report to GE Service department.

## 8.2 Troubleshooting: General Checklist

### Introduction

Check the items in the following topics before starting more in-depth troubleshooting work.

---

### System checks

- Is the correct system selected in UNICORN **System Control**? For more details, see [Section 5.3 Start UNICORN and connect to system, on page 157](#).
  - Are the fans blowing at the back and at the right side of the system?
- 

### Monitor checks

- Is the UV monitor set to the correct wavelength? Check the wavelengths that are used in the method. For the predefined methods the wavelengths are set in the **Method Settings** phase. For more details, see UNICORN Method Manual.
  - Is the air sensor sensitivity set to normal in UNICORN **System Control: System Settings** to avoid unnecessary stops due to minor air bubbles?
- 

### Instrument communication

- Have Node IDs been set correctly for all instrument modules? To check and change Node IDs, see [Node ID, on page 76](#).
- 

### Flow path checks

- Is all tubing connected correctly? See [Section 9.3 Tubing and connectors, on page 420](#) and [Section 5.2 Prepare the flow path, on page 150](#).
- Is there leakage at any of the connections?
- Is any tubing folded or twisted?
- Is the inlet tubing correctly immersed in the buffer solution, beneath the liquid surface but not too close to the flask bottom?
- Have Fraction collector F9-R and Fraction collector F9-C been correctly prepared? For more details, see relevant sections in [Chapter 3 ÄKTA pure external modules, on page 86](#) and [Chapter 4 System configuration, on page 123](#).
- Are the inlet and inline filters clean or are they generating a back pressure higher than normal? If this is the case, change the inline and inlet filters. For more details, see [Section 7.3.2 Replace the inline filter, on page 266](#) and [Section 7.8.8 Replace the inlet filters, on page 331](#).

- Does the positioning of the columns correspond to the selections made in the method? For more details, see [Section 5.5 Connect a column, on page 172](#).
- 

## Purification checks

- Have all columns been cleaned and prepared according to the column recommendations?
  - Have the samples been adjusted to binding buffer conditions?
  - Have the samples been clarified by centrifugation and/or filtration prior to sample loading?
  - Are the correct buffers used for the chosen columns and proteins?
  - Check buffers for precipitations. Adjust to room temperature.
  - Are the chosen columns suitable for the chosen target proteins?
  - Do the buffers have correct pH? The pH of some buffers changes with the temperature.
  - Are the UV-wavelengths used by the method appropriate with respect to used buffers and proteins? For more details see the method handbooks available from GE.
-

## 8.3 Troubleshooting: Monitors

### In this section

- UV monitor and UV detector
- Conductivity monitor
- pH monitor and pH valve
- Pressure monitors

### UV monitor U9-M and UV detector unit

Problem	Possible cause and action
The UV module is not found by the instrument	<ul style="list-style-type: none"><li>• <b>Communication problem</b> Contact Service.</li><li>• <b>The cable between the UV module and the ICU is not connected</b> Remove the UV module and make sure that the cable is connected.</li><li>• <b>Wrong Node ID</b> Check the module's Node ID. If necessary, change the Node ID. See <a href="#">Node ID, on page 76</a>.</li></ul>
No UV signal	<ul style="list-style-type: none"><li>• <b>The lamp is turned off.</b> Turn the lamp on with the Manual instruction Monitors – UV lamp.</li></ul>
Too low UV lamp intensity	<ul style="list-style-type: none"><li>• <b>The detector is not correctly fitted</b> Contact Service.</li><li>• <b>Unclean optical fiber connectors</b> Clean the connectors. See <a href="#">Section 7.8.5 Replace the UV monitor U9-M flow cell, on page 325</a>.</li><li>• <b>Dirt on optical sensors in detector</b> Remove visible dirt on detector photo diodes. Use lint free lens paper winded around a thin wood splinter (e.g a match or toothpick). Clean the sensors with Isopropanol through the small hole of the metal plate which covers the sensors. Dry the sensors with clean and dry lint free lens paper.</li><li>• <b>Worn-out or broken lamp</b> Contact Service.</li></ul>



Problem	Possible cause and action
<p><b>No light transmission through the UV cell</b></p>	<ul style="list-style-type: none"> <li>• <b>Wrong wavelength for current buffer</b> Change wavelength or buffer.</li> <li>• <b>Dirt in the UV flow cell</b> Clean the UV cell. See <a href="#">Section 7.5.1 Clean the UV flow cell, on page 273</a>.</li> <li>• <b>Unclean optical fiber connectors</b> Clean the connectors. See <a href="#">Section 7.8.5 Replace the UV monitor U9-M flow cell, on page 325</a>.</li> <li>• <b>Broken UV flow cell</b> Replace UV flow cell. See <a href="#">Section 7.8.5 Replace the UV monitor U9-M flow cell, on page 325</a>.</li> </ul>
<p><b>Autozero out of accepted range</b></p>	<ul style="list-style-type: none"> <li>• <b>Wrong wavelength for current buffer</b> Change wavelength or buffer.</li> <li>• <b>Unclean optical fiber connectors</b> Clean the connectors. See <a href="#">Section 7.8.5 Replace the UV monitor U9-M flow cell, on page 325</a>.</li> </ul>
<p><b>The internal temperature of the UV monitor is too high</b></p>	<ul style="list-style-type: none"> <li>• <b>The air intake on the rear or on the left side of the instrument is covered</b> Make sure that none of the air intakes on the instrument are covered.</li> <li>• <b>Hot surroundings</b> Decrease the room temperature. Maximum operating temperature is 35°C.</li> <li>• <b>Hardware error</b> Switch off the instrument and wait until the temperature has decreased. Restart the instrument. If this error is recurrent, generate a System error report and contact Service.</li> </ul>
<p><b>UV cell path length unreadable</b></p>	<ul style="list-style-type: none"> <li>• <b>No UV flow cell is attached</b> Attach UV cell. See <a href="#">Section 7.8.5 Replace the UV monitor U9-M flow cell, on page 325</a>.</li> <li>• <b>UV flow cell is not correctly installed.</b> Verify that the UV cell is correctly installed. See <a href="#">Section 7.8.5 Replace the UV monitor U9-M flow cell, on page 325</a></li> <li>• <b>The UV flow cell is broken</b> Replace the cell. See <a href="#">Section 7.8.5 Replace the UV monitor U9-M flow cell, on page 325</a>.</li> </ul>

Problem	Possible cause and action
<b>Ghost peaks</b>	<ul style="list-style-type: none"><li data-bbox="651 314 1439 619">• <b>Air in the UV flow cell</b> Use the Flow restrictor. Use the pH valve instruction to manually set the Flow restrictor inline (<i>Flow path:pH valve:Restrictor inline</i>), or select the Flow restrictor in the <b>Method Settings</b> phase of a method. Remove the air by flushing the cell with water or buffer. If persistent, clean the UV cell. See <a href="#">Section 7.5.1 Clean the UV flow cell, on page 273</a>.</li><li data-bbox="651 640 1439 719">• <b>Air in buffers</b> De-gas if necessary.</li><li data-bbox="651 740 1439 853">• <b>Dirt in the UV flow cell</b> Clean the UV cell. See <a href="#">Section 7.5.1 Clean the UV flow cell, on page 273</a>.</li><li data-bbox="651 874 1439 1023">• <b>Dirt in the flow path</b> Clean the system in accordance to <a href="#">Section 7.6.2 Perform System CIP, on page 278</a>. Clean the column in accordance to <a href="#">Section 7.6.3 Perform Column CIP, on page 284</a>.</li></ul>

Problem	Possible cause and action
<p><b>Baseline drift or noisy signal</b></p>	<ul style="list-style-type: none"> <li data-bbox="710 314 1497 500"> <p>• <b>Flow restrictor in off-line position</b></p> <p>Use the Flow restrictor. Use the pH valve instruction to manually set the Flow restrictor inline (<b>Flow path:pH valve:Restrictor in-line</b>), or select the Flow restrictor in the <b>Method Settings</b> phase of a method.</p> </li> <li data-bbox="710 521 1497 723"> <p>• <b>Air in the UV flow cell</b></p> <p>Use the Flow restrictor.</p> <p>Remove the air by flushing the cell with water or buffer.</p> <p>If persistent, clean the UV cell. See <a href="#">Section 7.5.1 Clean the UV flow cell, on page 273</a>.</p> </li> <li data-bbox="710 744 1497 819"> <p>• <b>Air in buffers</b></p> <p>De-gas if necessary.</p> </li> <li data-bbox="710 840 1497 904"> <p>• Make sure that both the instrument and the buffers have reached the ambient temperature.</p> </li> <li data-bbox="710 925 1497 1000"> <p>• <b>Impure buffers</b></p> <p>Check if the signal is noisy with water.</p> </li> <li data-bbox="710 1021 1497 1138"> <p>• <b>Unclean optical fiber connectors</b></p> <p>Clean the connectors. See <a href="#">Section 7.8.5 Replace the UV monitor U9-M flow cell, on page 325</a>.</p> </li> <li data-bbox="710 1159 1497 1351"> <p>• <b>Dirt in the UV flow cell</b></p> <p>Perform a System CIP. See <a href="#">Section 7.6.2 Perform System CIP, on page 278</a>.</p> <p>If necessary, manually clean the UV cell. See <a href="#">Section 7.5.1 Clean the UV flow cell, on page 273</a>.</p> </li> <li data-bbox="710 1372 1497 1478"> <p>• <b>Wrong type of UV cell is used</b></p> <p>If a UV cell with 2 mm path length is to be used, use only cells marked <b>U9-2</b>.</p> </li> </ul>

Problem	Possible cause and action
Unstable signal	<ul style="list-style-type: none"> <li> <b>Bad pump function</b>  Check that the pump is operating properly. See <a href="#">Select Mixer chamber, on page 151</a> for example of pump pressure curves. </li> <li> <b>Poor mixing function</b>  Check the mixer chamber size and change the chamber if necessary. See <a href="#">Select Mixer chamber, on page 151</a>.  Check the function of the mixer. Place a stirrer bar in the palm of your hand. Hold the hand above the mixer. The stirrer should move when the mixer is activated.  Check that the mixer chamber is free from solids. To open the mixer, see <a href="#">Section 7.3.2 Replace the inline filter, on page 266</a>. </li> </ul>
The UV curve shows a gradient that is inverted compared to the expected gradient	<ul style="list-style-type: none"> <li> <b>Large difference in refractive index between buffer A and buffer B</b>  Due to light spreading effects in the UV cell, the buffer with the highest UV absorption shows the lowest UV absorption in the chromatogram, and the buffer with the lowest UV absorption shows the highest UV absorption. This can occur if there is a large difference in refractive index between buffer A and buffer B and the UV is run at high sensitivity. </li> </ul>

## UV monitor U9-L

Problem	Possible cause and action
No UV signal	<ul style="list-style-type: none"> <li> <b>The lamp is turned off.</b>  Turn the lamp on with the Manual instruction Monitors – UV lamp. </li> </ul>
Autozero out of accepted range	<ul style="list-style-type: none"> <li> <b>Wrong UV flow cell for current buffer</b>  Change to a shorter UV flow cell or change buffer. </li> <li> <b>The UV flow cell is not correctly installed</b>  Check that the UV flow cell is fitted correctly, see <a href="#">Section 7.8.6 Replace the UV monitor U9-L flow cell, on page 328</a>. </li> <li> <b>Broken UV flow cell</b>  Replace the cell, see <a href="#">Section 7.8.6 Replace the UV monitor U9-L flow cell, on page 328</a>. </li> </ul>

Problem	Possible cause and action
<p><b>The internal temperature of the UV monitor is too high</b></p>	<ul style="list-style-type: none"> <li>• <b>The air intake on the rear or on the right side of the instrument is covered</b> Make sure that none of the air intakes on the instrument are covered.</li> <li>• <b>Hot surroundings</b> Decrease the room temperature. Maximum operating temperature is 35°C.</li> <li>• <b>Hardware error</b> Switch off the instrument and wait until the temperature has decreased. Restart the instrument. If this error is recurrent, generate a System error report and contact Service.</li> </ul>
<p><b>Maximum absorbance that can be measured by the detector is reached</b></p>	<ul style="list-style-type: none"> <li>• <b>Wrong UV flow cell for current buffer</b> Change to a shorter UV flow cell or change buffer.</li> <li>• <b>The UV flow cell is not correctly installed</b> Check that the UV flow cell is fitted correctly, see <a href="#">Section 7.8.6 Replace the UV monitor U9-L flow cell, on page 328.</a></li> <li>• <b>Dirt in the UV flow cell</b> Clean the UV flow cell, see <a href="#">Section 7.5.1 Clean the UV flow cell, on page 273.</a></li> <li>• <b>Broken UV flow cell</b> Replace the cell, see <a href="#">Section 7.8.6 Replace the UV monitor U9-L flow cell, on page 328.</a></li> </ul>
<p><b>The UV cell is not correctly installed</b></p>	<ul style="list-style-type: none"> <li>• Check that the UV flow cell is fitted correctly, see <a href="#">Section 7.8.6 Replace the UV monitor U9-L flow cell, on page 328.</a></li> </ul>

Problem	Possible cause and action
<p><b>Ghost peaks</b></p>	<ul style="list-style-type: none"> <li>• <b>Air in the UV flow cell</b> Use the Flow restrictor. Use the pH valve instruction to manually set the Flow restrictor inline (<i>Flow path:pH valve:Restrictor inline</i>), or select the Flow restrictor in the <b>Method Settings</b> phase of a method. Remove the air by flushing the cell with water or buffer. If persistent, clean the UV cell. See <a href="#">Section 7.5.1 Clean the UV flow cell, on page 273</a>.</li> <li>• <b>Air in buffers</b> De-gas if necessary.</li> <li>• <b>Dirt in the UV flow cell</b> Clean the UV cell. See <a href="#">Section 7.5.1 Clean the UV flow cell, on page 273</a>.</li> <li>• <b>Dirt in the flow path</b> Clean the system in accordance to <a href="#">Section 7.6.2 Perform System CIP, on page 278</a>. Clean the column in accordance to <a href="#">Section 7.6.3 Perform Column CIP, on page 284</a>.</li> </ul>
<p><b>The UV lamp is broken or worn out</b></p>	<ul style="list-style-type: none"> <li>• Contact Service</li> </ul>

Problem	Possible cause and action
Distorted protein peaks in IEX gradients (for example step gradients).	<ul style="list-style-type: none"> <li> <b>Rapid changes of the refractive index</b>                      The refractive index of the buffer changes rapidly in quick IEX gradients. The rapid change may cause light spreading effects and disturb the shape of the protein peaks in the U9-L 2 mm flow cell.                      Run with reversed flow direction through the 2 mm cell: connect the inlet tubing at the bottom and the outlet tubing at the top of the flow cell.  <b>Note:</b>                      The standard tubing (7) between the UV monitor and the conductivity monitor is too short (170 mm) for mounting the monitor for reversed flow direction. Perform the following actions:                     <ol style="list-style-type: none"> <li>1 Replace the standard tubing with a tubing that is 210 mm long.</li> <li>2 Update the total delay volume. The increase in volume depends on the inner diameter (i.d.) of the tubing:                             <ul style="list-style-type: none"> <li>- i.d. 0.25 mm : 2 <math>\mu</math>l</li> <li>- i.d. 0.50 mm : 8 <math>\mu</math>l</li> <li>- i.d. 0.75 mm: 18 <math>\mu</math>l</li> <li>- i.d. 1.0 mm: 32 <math>\mu</math>l</li> </ul> </li> </ol> </li> </ul>

## Conductivity monitor

Problem	Possible cause and action
The conductivity part of the system performance test failed	<p>Test was performed at cold room temperature and the conductivity temperature compensation factor was not optimized.</p> <p>In the <b>System Settings</b> dialog, select <b>Conductivity:Cond temp compensation</b> and set the <b>Compensation factor</b> to 2.1%.</p>
The cell constant measurement has been aborted	<ul style="list-style-type: none"> <li> <b>Internal errors</b>                      See error log. Restart instrument and retry. If this problem recurs, generate a System error report and contact Service.                 </li> </ul>
Unstable conductivity	<ul style="list-style-type: none"> <li> <b>Air in the Conductivity flow cell</b>                      Flush the Conductivity flow cell with water.                 </li> <li> <b>Solids in the Conductivity flow cell</b>                      Clean the Conductivity cell. See <a href="#">Section 7.6.10 Clean the Conductivity flow cell, on page 300</a>.                 </li> </ul>

Problem	Possible cause and action
<p><b>Temperature out of range for calibration</b></p>	<ul style="list-style-type: none"> <li> <p><b>This error can only occur when the temperature compensation is turned on. The error will occur when the temperature is outside the range 2°C to 40°C.</b></p> <p>Make sure the temperature of the calibration solution is within 2°C and 40°C.</p> </li> </ul>
<p><b>Baseline drift of noisy signal</b></p>	<ul style="list-style-type: none"> <li> <p><b>Air in the Conductivity flow cell</b></p> <p>Use the Flow restrictor.</p> <p>Remove the air by flushing the flow cell with water or buffer.</p> </li> <li> <p><b>Leaking tubing connections</b></p> <p>Tighten the connectors. If necessary, replace the connectors.</p> </li> <li> <p><b>Unclean Conductivity flow cell</b></p> <p>Clean the Conductivity flow cell. See <a href="#">Section 7.6.10 Clean the Conductivity flow cell, on page 300</a>.</p> </li> <li> <p><b>Poor mixing function</b></p> <p>Check the Mixer chamber size and change chamber if necessary, see <a href="#">Select Mixer chamber, on page 151</a>.</p> <p>Check the motor operation of the Mixer. Place a magnet close to the Mixer chamber during run. The magnet should vibrate.</p> <p>Check that the Mixer chamber is free from solids. To replace the inline filter, see <a href="#">Section 7.3.2 Replace the inline filter, on page 266</a>.</p> </li> </ul>
<p><b>Conductivity measurement with the same buffer appears to decrease/increase over time.</b></p>	<ul style="list-style-type: none"> <li> <p><b>Unclean conductivity flow cell</b></p> <p>Clean the Conductivity cell, see <a href="#">Section 7.6.10 Clean the Conductivity flow cell, on page 300</a>.</p> </li> <li> <p><b>The ambient temperature may have decreased/increased</b></p> <p>Use a temperature compensation factor. The temperature compensation factor is found in <b>System Control: System Settings: Conductivity</b>. Instruction regarding the factor is also found in <a href="#">Section 7.7.3 Calibrate the Conductivity monitor, on page 308</a>.</p> </li> <li> <p><b>The Conductivity monitor needs to be calibrated</b></p> <p>Check calibration with a solution with known conductivity.</p> <p>Calibrate the Conductivity monitor, see <a href="#">Section 7.7.3 Calibrate the Conductivity monitor, on page 308</a>.</p> </li> </ul>



Problem	Possible cause and action
<p><b>Waves on the gradient</b></p>	<ul style="list-style-type: none"> <li>• <b>Bad pump function</b> Check that the pump is operating properly. See <a href="#">Examples of pump pressure curves, on page 390</a> for example of pump pressure curves.</li> <li>• <b>Air in the flow path</b> Purge the pumps. See <a href="#">Section 5.4.1 System pumps, on page 161</a>.</li> <li>• <b>Poor mixing function</b> Check that the correct Mixer chamber size is used. See <a href="#">Select Mixer chamber, on page 151</a> for recommendations. To change the Mixer, see <a href="#">Section 7.8.3 Replace the Mixer, on page 322</a>.  Check the motor operation of the Mixer. Place a magnet close to the mixer chamber during run. The magnet should vibrate.  Check that the Mixer chamber is free from solids. To open the mixer, see <a href="#">Section 7.3.2 Replace the inline filter, on page 266</a>.</li> </ul>
<p><b>Ghost peaks appear in the gradient profile</b></p>	<ul style="list-style-type: none"> <li>• <b>A charged particle has been detected</b> Prepare the sample so that charged particles are eliminated.</li> <li>• <b>Air bubbles are passing through the flow cell</b> Check for loose tubing connections. Use the Flow restrictor.</li> </ul>
<p><b>Non-linear gradients or slow response to %B changes</b></p>	<ul style="list-style-type: none"> <li>• <b>Dirt in the tubing</b> Make sure that the tubing has been washed properly.</li> <li>• <b>Bad pump function</b> Make sure that the pump operates properly. See <a href="#">Examples of pump pressure curves, on page 390</a> for example of pump pressure curves.</li> <li>• <b>The Mixer chamber is too large</b> Change to a Mixer chamber with a smaller volume. See <a href="#">Select Mixer chamber, on page 151</a> for recommendations. To change the Mixer, see <a href="#">Section 7.8.3 Replace the Mixer, on page 322</a>.</li> </ul>

Problem	Possible cause and action
<p><b>Incorrect or unstable reading</b></p>	<ul style="list-style-type: none"> <li> <p>• <b>The temperature compensation factor is not properly set</b></p> <p>Use a temperature compensation factor. The temperature compensation factor is found in <b>System Control: System Settings: Conductivity</b>. Instruction regarding the factor is also found in <a href="#">Section 7.7.3 Calibrate the Conductivity monitor, on page 308</a>.</p> </li> <li> <p>• <b>The column is not equilibrated</b></p> <p>Equilibrate the column. Use the method phase <b>Equilibration</b>. If necessary, clean the column. Use the predefined method <b>Column CIP</b>. See <a href="#">Section 7.6.3 Perform Column CIP, on page 284</a>.</p> </li> <li> <p>• <b>Poor mixing function</b></p> <p>Check that the correct Mixer chamber size is used. See <a href="#">Select Mixer chamber, on page 151</a> for recommendations. To change the Mixer, see <a href="#">Section 7.8.3 Replace the Mixer, on page 322</a>.</p> <p>Check the motor operation of the mixer. Place a magnet close to the Mixer chamber during run. The magnet should vibrate.</p> <p>Check that the Mixer chamber is free from solids. To open the mixer, see <a href="#">Section 7.3.2 Replace the inline filter, on page 266</a>.</p> </li> </ul>

## pH monitor and pH valve

Problem	Possible cause and action
<p><b>The pH module is not found by the instrument</b></p>	<ul style="list-style-type: none"> <li> <p>• <b>The cable between the pH valve and the ICU is not connected</b></p> <p>Remove the pH valve and make sure that the cable is connected. See <a href="#">Hardware installation of a module, on page 76</a>.</p> </li> </ul>
<p><b>The internal valve temperature is too high</b></p>	<ul style="list-style-type: none"> <li> <p>• <b>The air intake on the rear or on the left side of the instrument is covered</b></p> <p>Make sure that none of the air intakes on the instrument are covered.</p> </li> <li> <p>• <b>Hot surroundings</b></p> <p>Decrease the room temperature. Maximum operating temperature is 35°C.</p> </li> <li> <p>• <b>Hardware error</b></p> <p>Switch off the instrument and wait until the temperature has decreased. Restart the instrument. If this error is recurrent, generate a System error report and contact Service.</p> </li> </ul>

Problem	Possible cause and action
<p><b>Unstable pH signal</b></p>	<ul style="list-style-type: none"> <li> <p>• <b>Calibration time out</b></p> <p>Check the connections between pH electrode and pH monitor. Regenerate the pH electrode. Place the electrode in deionized water for 30 minutes followed by 30 minutes in a buffer with pH 4.</p> <p>If persistent, replace the pH electrode. See <a href="#">Section 7.5.2 Replace the pH electrode, on page 275</a>.</p> </li> <li> <p>• <b>Bad pH electrode</b></p> <p>Regenerate the pH electrode. Place the electrode in deionized water for 30 minutes followed by 30 minutes in a buffer with pH 4.</p> <p>Clean the pH electrode. See <a href="#">Section 7.6.7 Clean the pH electrode, on page 293</a>.</p> <p>If persistent, replace the pH electrode. See <a href="#">Section 7.5.2 Replace the pH electrode, on page 275</a>.</p> </li> <li> <p>• <b>Wrong mixer size for the used flow rate</b></p> <p>Use the recommended mixer size for the used flow rate. See</p> </li> </ul>
<p><b>Drift of pH signal when the pH electrode has been removed from storage solution</b></p>	<ul style="list-style-type: none"> <li> <p>• <b>Decreasing salt concentration in the electrode membrane due to osmosis to buffer</b></p> <p>Regenerate the pH electrode. Place the electrode in deionized water for 30 minutes followed by 30 minutes in a buffer with pH 4.</p> </li> </ul>
<p><b>Temperature reading error</b></p>	<ul style="list-style-type: none"> <li> <p>• <b>The temperature compensation of the pH monitor is turned off</b></p> <p>Contact Service.</p> </li> </ul>
<p><b>It is not possible to inject calibration solution</b></p>	<ul style="list-style-type: none"> <li> <p>• <b>Waste tubing is twisted or blocked</b></p> <p>Untwist the tubing.</p> <p>Perform System CIP to clean waste tubing. See <a href="#">Section 7.6.2 Perform System CIP, on page 278</a>.</p> <p>Change the tubing.</p> </li> </ul>

Problem	Possible cause and action
<p>Alarm in UNICORN: <b>(Alarm)</b> <b>The pH cell can only be run at pressures below 0.8 MPa. Please check the tubing or lower the flow through the pH cell.</b></p> <p><b>Note:</b> The pressure limit 0.8 MPa is for the post column pressure.</p>	<ul style="list-style-type: none"> <li>• <b>High pressure in the pH cell</b> Decrease the flow rate. Bypass the pH electrode (see <a href="#">Ports and flow paths of the pH valve, on page 61</a>) and measure pH in fractions manually.</li> </ul>

## Pressure monitors

Problem	Possible cause and action
<p><b>Pressure offset</b></p>	<ul style="list-style-type: none"> <li>• <b>The monitors have lost their calibration</b> Calibrate the pressure monitors. See <a href="#">Section 7.7.2 Calibrate the pressure monitors, on page 305</a>.</li> <li>• <b>The temperature has changed</b> Wait until the temperature has stabilized and calibrate the pressure monitors.</li> </ul>
<p><b>Excessively high pressure values</b></p>	<ul style="list-style-type: none"> <li>• <b>Unclean inline filter in the Mixer</b> Replace the inline filter in the Mixer. See <a href="#">Section 7.3.2 Replace the inline filter, on page 266</a>.</li> <li>• <b>Solids in the flow path</b> To use the predefined method System CIP to clean the flow path, see <a href="#">Section 7.6.2 Perform System CIP, on page 278</a>. To clean the column, see <a href="#">Section 7.6.3 Perform Column CIP, on page 284</a>. If persistent, replace the column.</li> <li>• <b>0.25 mm i.d. tubing kit is mounted</b> A smaller tubing inner diameter gives higher back pressure. The back pressure for the 0.25 mm i.d. tubing kit is normally 16 times higher than for the 0.50 mm i.d. tubing kit used at the same running conditions. Maximum system flow rate for 0.25 mm i.d. tubing is 10 ml/min</li> </ul>
<p><b>The pressure monitors are not found by the instrument</b></p>	<ul style="list-style-type: none"> <li>• <b>The cable between the Pressure monitors and the ICU is not connected.</b> Remove the monitor and make sure that the cable is connected.</li> </ul>

Problem	Possible cause and action
<b>The internal temperature of the pressure monitor is too high</b>	<ul style="list-style-type: none"><li data-bbox="708 314 1495 463">• <b>The air intake on the rear or on the left side of the chromatography instrument or the sample pump is covered</b> Make sure that none of the air intakes on the instrument are covered.</li><li data-bbox="708 485 1495 602">• <b>Hot surroundings</b> Decrease the room temperature. Maximum operating temperature is 35°C.</li><li data-bbox="708 623 1495 761">• <b>Hardware error</b> Switch off the instrument and wait until the temperature has decreased. Restart the instrument. If this error is recurrent, generate a System error report and contact Service.</li></ul>

Problem	Possible cause and action
<p><b>Irregular pressure curves</b></p>	<ul style="list-style-type: none"> <li data-bbox="651 314 1422 342"> <p>• <b>Air bubbles are passing through or are trapped in the pump</b></p> <p>Check that there is a sufficient volume of buffer present in the flasks.</p> <p>Check all connections for leaks.</p> <p>Check pump pressure curves. See <a href="#">Examples of pump pressure curves, on page 390</a> for examples of pump pressure curves.</p> <p>Purge the pumps, see <a href="#">Section 5.4.1 System pumps, on page 161</a> or <a href="#">Section 5.4.2 Sample pump, on page 167</a></p> </li> <li data-bbox="651 661 1401 810"> <p>• <b>The check valve does not function correctly</b></p> <p>Remove any solids in the valves by cleaning the check valves according to the instructions in <a href="#">Section 7.6.8 Clean the pump head check valves, on page 296</a>.</p> </li> <li data-bbox="651 836 1422 1059"> <p>• <b>Piston seal is leaking</b></p> <p>Replace the piston seal of a system pump according to the instructions in <a href="#">Section 7.8.10 Replace pump piston seals of Pump P9 or P9H, on page 335</a>. Replace the piston seal of the sample pump according to the instructions in <a href="#">Section 7.8.11 Replace pump piston seals of Pump P9-S, on page 344</a></p> </li> <li data-bbox="651 1081 1434 1634"> <p>• <b>Blockage of flow path</b></p> <p>Use the predefined method <b>Prepare System</b> to flush through to clear blockage.</p> <p>If necessary, replace tubing. See <a href="#">Section 7.8.1 Replace tubing and connectors, on page 317</a>.</p> <p>Check the mixer inline filter. It can be clogged if unfiltered buffers or samples are applied. See <a href="#">Section 7.3.2 Replace the inline filter, on page 266</a> for instructions how to replace the mixer inline filter.</p> <p>Check the inlet filters. They can be clogged if unfiltered buffers or samples are applied. To replace the filters, see <a href="#">Section 7.8.8 Replace the inlet filters, on page 331</a>.</p> <p>Check the column. It can be clogged if unfiltered buffers or samples are applied. To clean a column, see <a href="#">Section 7.6.3 Perform Column CIP, on page 284</a>.</p> </li> </ul>

## 8.4 Troubleshooting: Valves

### General

The following table lists the general problems that may occur for the different valves.

Problem	Possible cause and action
<p><b>The valve is not found by the instrument</b></p>	<ul style="list-style-type: none"> <li>• <b>The cable between the valve and the ICU is not connected</b> Remove the valve and make sure that the cable is connected. See <a href="#">Hardware installation of a module, on page 76</a>.</li> <li>• <b>Wrong Node ID</b> Check the valve Node ID. If necessary, change the Node ID. See <a href="#">Node ID, on page 76</a>.</li> </ul>
<p><b>The internal valve temperature is too high</b></p>	<ul style="list-style-type: none"> <li>• <b>The air intake on the rear or on the left side of the instrument is covered</b> Make sure that none of the air intakes on the instrument are covered.</li> <li>• <b>Hot surroundings</b> Decrease the room temperature. Maximum operating temperature is 35°C.</li> <li>• <b>Hardware error</b> Switch off the instrument and wait until the temperature has decreased. Restart the instrument. If this error is recurrent, generate a System error report and contact Service.</li> </ul>
<p><b>The valve is not switching or is switching to wrong position</b></p>	<ul style="list-style-type: none"> <li>• <b>Hardware error</b> Generate a System error report and contact Service.</li> </ul>
<p><b>External leakage</b></p>	<ul style="list-style-type: none"> <li>• <b>Hardware error</b> Generate a System error report and contact Service.</li> </ul>
<p><b>Internal leakage</b></p>	<ul style="list-style-type: none"> <li>• <b>Broken valve</b> Replace the valve. See <a href="#">Section 2.5 Installation of internal modules, on page 76</a>.</li> </ul>

## Inlet valves

The Inlet valves include Inlet valve V9-IA, V9H-IA, V9-IB, V9H-IB, V9-IAB, V9H-IAB, V9-IX and V9H-IX, as well as Sample inlet valve V9-IS and V9H-IS.

Problem	Possible cause and action
Faulty air sensor in the valve	<ul style="list-style-type: none"><li>• <b>Hardware error</b> Restart the instrument with the power switch. If this error is recurrent, generate a System error report and contact Service.</li></ul>

## pH valve

Problem	Possible cause and action
Leaking pH valve	<ul style="list-style-type: none"><li>• <b>The dummy electrode was dry when it was installed in the valve.</b><ol style="list-style-type: none"><li>1 Remove the dummy electrode.</li><li>2 Wet the dummy electrode properly with distilled water.</li><li>3 Insert the dummy electrode into the pH valve.</li><li>4 Rotate the dummy electrode before securing it with the nut.</li></ol></li></ul>

## Module Panel

Problem	Possible cause and action
The instrument is unable to find some of the modules	<ul style="list-style-type: none"><li>• <b>A Module Panel is missing and the position is left empty</b> Install the missing Module panel.</li><li>• <b>The cable between the Module Panel and the ICU is not connected</b> Remove the Module Panel and make sure that the cable is connected.</li></ul>



## 8.5 Troubleshooting: Fraction collector

### In this section

- Fraction collector F9-C
- Fraction collector F9-R

### Fraction collector F9-C

Problem	Possible cause and action
The fraction collector cannot be found by the instrument	<ul style="list-style-type: none"> <li>• <b>The cable between the fraction collector and the ÄKTA pure instrument is not connected</b> Generate a System error report and contact Service.</li> <li>• <b>A fuse in the instrument ICU is broken</b> The ICU needs to be changed. Generate a System error report and contact Service.</li> </ul>
Fraction collector arm is blocked or internal fault in the fraction collector	<ul style="list-style-type: none"> <li>• <b>Obstruction inside the fraction collector</b> Switch off the instrument and check for obstruction inside the fraction collector. Try to move the fractionation arm by hand. Switch on the instrument. If this error is recurrent, generate a System error report and contact Service.</li> </ul>
The accumulator is jammed or there is an internal error in the instrument	<ul style="list-style-type: none"> <li>• <b>Salt crystals or protein residuals block the accumulator</b> Restart the instrument and perform an accumulator wash.</li> <li>• <b>Mechanical error</b> If this error is recurrent, generate a System error report and contact Service.</li> </ul>
Fraction collection tube or well is overfilled and fractionation movements are lost.	<ul style="list-style-type: none"> <li>• <b>Too many commands are pending in the fraction collector</b> The reason could be that too many fraction collector instructions have been sent. Wait for a while and try again.</li> </ul>

Problem	Possible cause and action
<p><b>The fraction collector failed to detect the code on the Cassette</b></p>	<ul style="list-style-type: none"> <li>• <b>Cassette tray or tube rack is inserted in the wrong direction</b> Take it out and insert it in the correct direction.</li> <li>• <b>Unclean Cassette type code reader</b> Clean the dispenser head and its four diode windows using a cloth and a mild cleaning agent or 20% ethanol. See <a href="#">Section 7.6.4 Clean Fraction collector F9-C, on page 288</a> for more information.</li> <li>• <b>Unclean Cassette type codes</b> Clean the Cassette type codes. See <a href="#">Section 7.6.4 Clean Fraction collector F9-C, on page 288</a> for more information.  If this error is recurrent, set the Fraction collector configuration manually in UNICORN. In <b>System Control</b>, select <b>System:Settings</b>. Navigate to <b>Fraction collector:Cassette configuration</b> and select <b>Manual</b>.</li> </ul>
<p><b>The Cassette tray is loose in the fraction collector</b></p>	<ul style="list-style-type: none"> <li>• <b>The Tray guides in the fractionation chamber are missing</b> Replace the Tray guides. See <a href="#">Section 7.6.4 Clean Fraction collector F9-C, on page 288</a>.</li> <li>• <b>The Tray catch is broken</b> Contact service.</li> </ul>
<p><b>Calibration of the Drop sync sensor failed</b></p>	<ul style="list-style-type: none"> <li>• <b>Unclean Drop sync sensor diode windows</b> Clean the Drop sync sensor diode windows. See <a href="#">Section 7.6.4 Clean Fraction collector F9-C, on page 288</a> for location of the Drop sync sensor diode windows and cleaning instructions.  If this error is recurrent, generate a System error report and contact Service.</li> </ul>
<p><b>Drop sync does not work</b></p>	<ul style="list-style-type: none"> <li>• <b>Liquid spatter in the fraction collector</b> Change to another type of tubes or deepwell plates or collect fraction volumes of maximum two thirds of the volume of the tubes. Clean the diode windows of the drop sync sensor more frequently than once a week, using a cloth and a mild cleaning agent or 20% ethanol.</li> </ul>

Problem	Possible cause and action
<p><b>The Dispenser head failed to detect a drop</b></p>	<ul style="list-style-type: none"> <li>• <b>Air in the flow path</b> If this error is recurrent, generate a System error report and contact Service. Check the flow path for air. Fill system and purge pumps according to <a href="#">Section 5.4.1 System pumps, on page 161</a>.</li> <li>• <b>Unclean Drop sync sensor diode windows</b> Clean the diode windows of the Drop sync sensor. See <a href="#">Section 7.6.4 Clean Fraction collector F9-C, on page 288</a>. If this error is recurrent, generate a System error report and contact Service.</li> <li>• <b>Too high flow rate</b> Decrease the flow rate.</li> </ul>
<p><b>The Dispenser head failed to detect the flow properly and has switched to tube change with reduced accumulator functionality</b></p>	<ul style="list-style-type: none"> <li>• <b>Air in the flow path</b> Check the flow path for air. Fill system and purge pumps according to <a href="#">Section 5.4.1 System pumps, on page 161</a>. If this error is recurrent, generate a System error report and contact Service.</li> <li>• <b>Unclean diode windows in the Drop sync sensor</b> Clean the diode windows of the Drop sync sensor. See <a href="#">Section 7.6.4 Clean Fraction collector F9-C, on page 288</a>. If this error is recurrent, generate a System error report and contact Service.</li> </ul>
<p><b>The Dispenser head failed to detect a drop and has switched to tube change without Drop sync</b></p>	<ul style="list-style-type: none"> <li>• <b>Too high flow rate</b> Decrease the flow rate.</li> <li>• <b>Air in the flow path</b> Check the flow path for air. Fill system and purge pumps according to <a href="#">Section 5.4.1 System pumps, on page 161</a>. If this error is recurrent, generate a System error report and contact Service.</li> <li>• <b>Unclean diode windows in the Drop sync sensor</b> Clean the diode windows of the Drop sync sensor. See <a href="#">Section 7.6.4 Clean Fraction collector F9-C, on page 288</a>. If this error is recurrent, generate a System error report and contact Service.</li> </ul>
<p><b>Tubes do not fit in the Cassette</b></p>	<ul style="list-style-type: none"> <li>• <b>Wrong tube dimensions are used</b> Check that the used tubes have the right dimensions. See <a href="#">Fraction collector tubes and bottles, on page 99</a> for information about tubes and Cassettes.</li> <li>• <b>QuickRelease function is worn out</b> Order a new Cassette. See <a href="#">Chapter 10</a> for ordering information.</li> </ul>

Problem	Possible cause and action
<b>Deep well plate does not fit in the Cassette</b>	<ul style="list-style-type: none"> <li> <b>Unsupported deep well plate model</b>            Check that the deep well plates are supported. See <a href="#">Deep well plates, on page 100</a>.         </li> </ul>
<b>The Cassette does not fit the Cassette tray</b>	<ul style="list-style-type: none"> <li> <b>The Cassette is turned in the wrong direction</b>            See <a href="#">Prepare and insert the Cassette tray, on page 194</a> for information of how to place the Cassettes.         </li> <li> <b>Objects or dirt under the Cassette</b>            Remove the object or dirt.         </li> </ul>
<b>Cassette tray in wrong position</b>	<ul style="list-style-type: none"> <li> <b>The Tray guides in the fractionation chamber are missing</b>            Replace the Tray guides. See <a href="#">Section 7.6.4 Clean Fraction collector F9-C, on page 288</a>.         </li> <li> <b>The Cassette tray is facing the wrong direction</b>            Make sure that the front of the tray (marked with the GE-logotype) is facing outwards. See <a href="#">Prepare and insert the Cassette tray, on page 194</a>.         </li> <li> <b>Dirt under the Cassette tray</b>            Remove the dirt.         </li> </ul>
<b>The loaded Cassette tray cannot be inserted into the fractionation collector</b>	<ul style="list-style-type: none"> <li> <b>The Cassette tray is facing the wrong direction</b>            Check that the GE-logotype is facing outwards when the tray is inserted into the fraction collector.         </li> <li> <b>Some of the tubes or plates are incorrectly placed in the Cassettes</b>            Check that all tubes and plates are correctly inserted in the Cassettes. See <a href="#">Prepare and insert the Cassette tray, on page 194</a> .         </li> <li> <b>Some of the tubes or plates have the wrong dimensions</b>            Check that the deep well plates and the tubes used are of the right type. See <a href="#">Fraction collector tubes and bottles, on page 99</a> and <a href="#">Deep well plates, on page 100</a> for information about supported tubes and plates.         </li> </ul>

Problem	Possible cause and action
<p><b>Quick scan or Full scan does not work</b></p>	<ul style="list-style-type: none"> <li>• <b>The Tray guides in the fractionation chamber are missing</b> Replace the Tray guides. See <a href="#">Section 7.6.4 Clean Fraction collector F9-C, on page 288</a>.</li> <li>• <b>The Cassette tray is facing the wrong direction</b> Check that the GE-logotype is facing outwards.</li> <li>• <b>The Cassette type codes are unclean</b> Clean the the Cassette type codes.</li> <li>• <b>The QuickRelease of a Cassette is in open position</b> Close the Cassette. See <a href="#">Prepare and insert the Cassette tray, on page 194</a>.</li> <li>• <b>The Cassette code reader diode window is unclean</b> Clean the Cassette code reader diode window. See <a href="#">Section 7.6.4 Clean Fraction collector F9-C, on page 288</a>.</li> <li>• <b>The automatic scanning is turned off in UNICORN</b> Make sure that the automatic scanning is turned on in UNICORN software. In <b>System Control</b>, select <b>System:Settings</b>. Navigate to <b>Fraction collector:Cassette configuration</b> and select <b>Automatic</b>.</li> <li>• <b>Wells in deep well plates are prefilled to a volume above 25% of the total well volume</b> Full scan will not work with prefilled wells during these conditions.</li> <li>• <b>Hardware error</b> Generate a System error report and contact Service.</li> </ul>
<p><b>The interior of the fraction collector is dark</b></p>	<ul style="list-style-type: none"> <li>• <b>The light has been turned off in UNICORN</b> Turn on the light in UNICORN. In <b>System Control</b>, select <b>System:Settings</b>. Navigate to <b>Fraction collector:Fraction collector lamp</b> and select <b>Lamps On</b>.</li> <li>• <b>The lamp is broken</b> Contact Service.</li> </ul>

Problem	Possible cause and action
<p>The waste or the interior of the fraction collector is flooded</p>	<ul style="list-style-type: none"> <li>• <b>The waste tubing is positioned so that the flow is obstructed</b> Untwist the waste tubing.</li> <li>• <b>The waste container is placed in a position higher than the waste outlet</b> Place the waste container in a position lower than the waste outlet.</li> <li>• <b>The waste tubing is blocked.</b> Clean or replace the waste tubing.</li> </ul>
<p>The liquid leaving the nozzle does not strike the waste funnel</p>	<ul style="list-style-type: none"> <li>• <b>Check the position of the waste funnel</b> Refit the waste funnel.</li> </ul>
<p>The tubing in the fraction collector is blocked</p>	<ul style="list-style-type: none"> <li>• <b>Salt residuals in the tubing</b> Perform a <i>Fraction collector wash</i>, see <a href="#">Section 7.6.4 Clean Fraction collector F9-C, on page 288</a>. If persistent, contact Service.</li> </ul>
<p>The fraction volume found in the tubes or wells are smaller than expected</p>	<ul style="list-style-type: none"> <li>• <b>Leakage on the wet side of the instrument</b> Localize the leakage and take care of the leakage, for example by tightening connectors.</li> <li>• <b>Air in pumps</b> Purge pumps. See <a href="#">Section 5.4.1 System pumps, on page 161</a>.</li> <li>• <b>Bad pump function</b> See troubleshooting of pumps in <a href="#">Section 8.6</a>.</li> <li>• <b>Leakage inside the Frac chamber</b> Contact Service.</li> </ul>
<p>Liquid on the floor of the fraction collector</p>	<ul style="list-style-type: none"> <li>• <b>The fingertight connector on the Dispenser head is not tight enough</b> Tighten the connector. Replace the connector if the leakage is persistent.</li> <li>• <b>The waste tubing or the waste funnel is blocked.</b> Make sure that there is no blockage or clogging and that the waste tubing not is bent.</li> <li>• <b>Leakage in the Frac arm</b> Contact service.</li> </ul>

Problem	Possible cause and action
<p><b>Spillage by the fraction collector during fractionation</b></p>	<ul style="list-style-type: none"> <li>• <b>Unclean diode windows in the Drop sync sensor or unclean nozzle</b> Clean the Drop sync diode windows and the nozzle. See <a href="#">Section 7.6.4 Clean Fraction collector F9-C, on page 288</a>. Use the Fraction collector cleaning position.</li> <li>• <b>Too high flow rate during usage of Drop sync</b> Use a flow rate below 2 ml/min.</li> <li>• <b>One or more Cassettes have empty positions</b> Make sure that all Cassette positions contain tubes or plates.</li> <li>• <b>The tubes are flooded</b> Make sure that the fraction volume is adapted to the tube volume. Fraction tubes have not been replaced by empty tubes when the Fraction collector was opened.</li> </ul>
<p><b>It is not possible to fractionate</b></p>	<ul style="list-style-type: none"> <li>• <b>The door of the fraction collector is not properly closed</b> Close the door.</li> </ul>
<p><b>The fraction collector fractionates in the wrong well or tube</b></p>	<ul style="list-style-type: none"> <li>• <b>Quick scan has not detected the correct Cassette</b> Clean the Cassette type code of the Cassette. See <a href="#">Section 7.6.4 Clean Fraction collector F9-C, on page 288</a>.</li> <li>• <b>Unsupported deep well plate is used.</b> Make sure that approved deep well plates are used. See <a href="#">Deep well plates, on page 100</a>.</li> <li>• <b>Wells in deep well plates are prefilled to a volume above 25% of the total well volume</b> Full scan will not work with prefilled wells during these conditions.</li> <li>• <b>The deep well plate is not correctly positioned in the Cassette</b> See <a href="#">Prepare and insert the Cassette tray, on page 194</a> for information of how to place the deep well plate.</li> <li>• <b>Dirt on the nozzle or Drop sync sensor diode windows. Dirt may effect where the drops fall.</b> Clean nozzle and Drop sync sensor diode windows. See <a href="#">Section 7.6.4 Clean Fraction collector F9-C, on page 288</a>.</li> </ul>
<p><b>Error message when the door of the fraction collector is opened during a run</b></p>	<ul style="list-style-type: none"> <li>• <b>Some parts in a method require that the door of the fraction collector is closed.</b> Do not open the door when the Fractionation indicator is lit.</li> </ul>

Problem	Possible cause and action
<p><b><i>Fraction collector wash is reported as Completed when it has been aborted.</i></b></p>	<p>The <b><i>Fraction collector wash</i></b> instruction is aborted when the fraction collector door is opened during state pause. When selecting to continue the run the instruction is reported as <b><i>Completed</i></b>, it should state <b><i>Cancelled</i></b>.</p> <p><b>Action:</b> Do not open the door during the <b><i>Fraction collector wash</i></b> instruction. If the door has been opened, restart the <b><i>Fraction collector wash</i></b> instruction to make sure that the Fraction collector wash has been performed as recommended.</p>
<p><b>The instrument does not fractionate via the Outlet valve ports</b></p>	<ul style="list-style-type: none"> <li>• <b>The Detector - Outlet valve delay volume has been set to zero.</b> <ol style="list-style-type: none"> <li>1 In <b><i>System Control</i></b>, select <b><i>System:Settings:Fraction collections:Delay volumes</i></b>.</li> <li>2 Correct the Detector - Outlet valve delay volume.</li> </ol> </li> </ul>
<p><b>When starting a method run during a manual run, the fraction collector generates an error message indicating that the wrong Cassettes are in place, even though the correct Cassettes are present in the Fraction collector.</b></p>	<p><b>Action:</b> End a manual run before starting a method run.</p>
<p><b>High pressure alarm when collecting fractions with the fraction collector</b></p>	<p><b>Action:</b></p> <ul style="list-style-type: none"> <li>• Decrease the flow rate or use Outlet valve fractionation, or</li> <li>• replace the following tubing with tubing of larger inner diameter (i.d.) <ul style="list-style-type: none"> <li>- the tubing between the outlet valve and the fraction collector and</li> <li>- the internal tubing of the fraction collector.</li> </ul> </li> </ul> <p><b>Note:</b></p> <p>Update the delay volume. In the <b><i>System Control</i></b> software module, select <b><i>System:Settings:Tubing and Delay volumes</i></b> and update the value for <b><i>Delay volume: Monitor to frac</i></b>.</p>
<p><b>Spillage in Fraction collector when the Frac arm is moving from Cassette placed in position 1 and 2 to waste</b></p>	<p><b>Action:</b> If possible, place the Cassettes close to waste, i.e., position 5 or 6 during fractionation.</p>



Problem	Possible cause and action
The fractionation starts in the first row again	<ul style="list-style-type: none"> <li>• <b>The door of the fraction collector has been opened between two runs. When the instrument is in state <i>Ready</i> and the door is opened and closed, the Fraction collector content is reset.</b> If fractionation will continue after the last fraction of the first run, do not open the door of the fraction collector between two runs.</li> </ul>
Spillage between fractions	<ul style="list-style-type: none"> <li>• <b>The combination of high flow rates and liquids with low surface tension might lead to spillage in the Fraction collector.</b> If possible use Cassette positions 5 and 6. Lower the flow rate when using liquids with low surface tension.</li> </ul>

## Fraction collector F9-R

Problem	Possible cause and action
The fraction collector cannot be found by the instrument	<ul style="list-style-type: none"> <li>• <b>The cable between the fraction collector and the ÄKTA pure instrument is not connected</b> Make sure that the cable is connected.</li> <li>• <b>Wrong node ID</b> Check the Node ID of the fraction collector. If necessary, change the Node ID. See <a href="#">Section 9.16 Node IDs, on page 502</a>.</li> </ul>
The internal temperature of the fraction collector is too high	<ul style="list-style-type: none"> <li>• <b>Hot surroundings</b> Decrease the room temperature. Maximum operating temperature is 35°C.</li> <li>• <b>Hardware error</b> Switch off the instrument and wait until the temperature has decreased. Restart the instrument. If this error is recurrent, generate a System error report and contact service.</li> </ul>

Problem	Possible cause and action
<p><b>The fraction collector failed to detect a drop and has changed tube without drop sync.</b></p>	<ul style="list-style-type: none"> <li>• <b>To high flow rate for drop sync</b> Decrease the flow rate or disable drop sync.</li> <li>• <b>Air in the flow path</b> Check the flow path for air. Fill system and purge pumps. If this error is recurrent, generate a System error report and contact service.</li> <li>• <b>Unclean drop sync sensor</b> Clean the drop sensor photocell located above the tube sensor with a damp cloth.</li> <li>• <b>The tubing is not correctly mounted in the tubing holder nut</b> Check that the tubing is correctly mounted, see <a href="#">Connect tubing to ÄKTA pure, on page 106</a>.</li> </ul>
<p><b>The tube sensor has not detected a new tube.</b></p>	<ul style="list-style-type: none"> <li>• <b>The fraction collector movement is blocked</b> Make sure that the fraction collector can move and is free from obstructions.</li> </ul>
<p><b>The delay queue is full or there is a tube change overload.</b></p>	<ul style="list-style-type: none"> <li>• <b>The flow rate is too high</b> Reduce the flow rate.</li> <li>• <b>The fraction volume is too small</b> Collect larger fractions.</li> <li>• <b>Too many fraction collector instructions have been sent</b> Wait for a while and try again.</li> </ul>
<p><b>Fraction numbering does not start at 1 when the fractionation is restarted after a <i>No tube</i> error</b></p>	<p><b>Fraction numbering continues from where it was at the time of the <i>No tube</i> error</b> Manually reset the fraction number in the <b>System settings</b> menu.</p>

## 8.6 Troubleshooting: Pumps

### In this section

- Troubleshooting for System pumps and Sample pumps
- Example of pump pressure curves
- Remove persistent air bubbles

### Pumps

Problem	Possible cause and action
<p><b>Liquid is leaking between the pump head and the side panel</b></p>	<ul style="list-style-type: none"> <li>• <b>Piston seal or rinsing membrane incorrectly fitted or worn</b> Replace or reinstall the seal or the membrane. For System pumps and Sample pump <b>S9H</b>, see <a href="#">Section 7.8.10 Replace pump piston seals of Pump P9 or P9H, on page 335</a>. For Sample pump <b>S9</b>, see <a href="#">Section 7.8.11 Replace pump piston seals of Pump P9-S, on page 344</a></li> </ul>
<p><b>Low eluent flow and noise</b></p>	<ul style="list-style-type: none"> <li>• <b>Air in pumps</b> Purge the pumps. See <a href="#">Section 5.4 Prime inlets and purge pump heads, on page 160</a> or <a href="#">Section 5.4.2 Sample pump, on page 167</a>.</li> <li>• <b>Bad piston spring</b> Disassemble the pump head and examine the piston spring. If the spring is corroded, check piston seal and rinse membrane. Make sure that the pump piston rinsing system is always used when working with aqueous buffers containing salt.</li> <li>• <b>Bad pump piston</b> If the piston is damaged, replace it according to <a href="#">Section 7.8.12 Replace pump pistons, on page 351</a>.</li> <li>• <b>Bad pump piston seal</b> Replace the piston seal and rinse membrane according to <a href="#">Section 7.8.10 Replace pump piston seals of Pump P9 or P9H, on page 335</a> or <a href="#">Section 7.8.11 Replace pump piston seals of Pump P9-S, on page 344</a>.</li> </ul>
<p><b>Leakage around a connector</b></p>	<ul style="list-style-type: none"> <li>• <b>Leaking connection and/or crystallized material around a connector</b> Unscrew the connector and check if it is worn or incorrectly fitted. If so, replace the connector. Gently finger tighten the connector.</li> </ul>

Problem	Possible cause and action
<b>Erratic pump pressure</b>	<ul style="list-style-type: none"> <li>• <b>Air trapped in the pump heads</b></li> <li>• <b>Partially blocked solvent filters</b></li> <li>• <b>Leaking connections</b></li> <li>• <b>Piston seal leakage</b></li> <li>• <b>Check valve malfunction</b></li> <li>• <b>Piston damaged</b></li> </ul> <p>See <a href="#">Examples of pump pressure curves, on page 390</a> for examples of pump pressure curves.</p>
<b>The pump is not found by the instrument</b>	<ul style="list-style-type: none"> <li>• <b>The cable between the system pump and the ICU is not connected.</b> Contact Service.</li> <li>• <b>The cable between the sample pump and the ÄKTA pure instrument is not connected.</b> Connect the cable.</li> <li>• <b>A fuse in the instrument ICU is broken.</b> Contact Service.</li> </ul>
<b>The internal temperature of the pump is too high</b>	<ul style="list-style-type: none"> <li>• <b>The air intake on the rear or on the left side of the instrument is covered</b> Make sure that none of the air intakes on the instrument are covered.</li> <li>• <b>Hot surroundings</b> Decrease the room temperature. Maximum operating temperature is 35°C.</li> <li>• <b>Hardware error</b> Switch off the instrument and wait until the temperature has decreased. Restart the instrument. If this error is recurrent, generate a System error report and contact Service.</li> </ul>
<b>High pressure alarm</b>	<ul style="list-style-type: none"> <li>• <b>The pressure has increased due to increased viscosity</b> The viscosity increases in cold room. Lower the flow when performing runs in a cold room.</li> </ul>

Problem	Possible cause and action
<p>High pressure alarm when pressure control is activated</p>	<ul style="list-style-type: none"> <li>• <b>The parameter selected for pressure control is not the most appropriate one</b> The pressure control is based on either the Pre column pressure or the Delta column pressure. To change the parameter for pressure control, select <b>Pre column pressure</b> or <b>Delta column pressure</b> from the <b>Pressure control</b> drop-down list in the <b>Instruction box</b> of the instruction of interest.</li> <li>• <b>The flow is too high</b> Lower the flow.</li> </ul>
<p>Abnormal difference in system pressure compared to pre column pressure</p>	<ul style="list-style-type: none"> <li>• <b>Clogged inline filter</b> Replace the inline filter, see <a href="#">Section 7.3.2 Replace the inline filter, on page 266</a>.</li> </ul>
<p>Internal pump error combined with high pressure</p>	<ul style="list-style-type: none"> <li>• <b>The flow path is blocked</b> Remove obstructions in the flow path. For example, remove stop plugs and replace constricted tubing.</li> </ul>
<p>Internal pump error at normal pressure</p>	<ul style="list-style-type: none"> <li>• <b>Blocked pump restrictor</b> Contact Service.</li> </ul>
<p>Too slow pressure build up when pressure control is active</p>	<ul style="list-style-type: none"> <li>• Too low I factor in the <b>Pressure control parameters</b> instruction In the <b>Manual Instructions</b> dialog, increase the <b>I factor</b> of the <b>Pressure control parameters</b> instruction.</li> </ul>
<p>Too slow pressure build up when using constant pressure flow</p>	<ul style="list-style-type: none"> <li>• Too low I factor in the <b>Constant pressure flow parameters</b> instruction In the <b>Manual Instructions</b> dialog, increase the <b>I factor</b> of the <b>Constant pressure flow parameters</b> instruction.</li> </ul>
<p>Pressure overshoot or oscillating pressure when pressure control is active</p>	<ul style="list-style-type: none"> <li>• Too high I factor in the <b>Pressure control parameters</b> instruction In the <b>Manual Instructions</b> dialog, decrease the <b>I factor</b> of the <b>Pressure control parameters</b> instruction.</li> </ul>
<p>Pressure overshoot or oscillating pressure when using constant pressure flow</p>	<ul style="list-style-type: none"> <li>• Too high I factor in the <b>Constant pressure flow parameters</b> instruction In the <b>Manual Instructions</b> dialog, decrease the <b>I factor</b> of the <b>Constant pressure flow parameters</b> instruction.</li> </ul>

## Examples of pump pressure curves

The table below shows some examples of pump system pressure curves obtained when errors have occurred. The examples can be useful in troubleshooting of the system pumps and the sample pump. The system pressure monitor R9 has higher resolution than the other pressure monitors, and is therefore recommended for troubleshooting purposes.

**Incident:** 30  $\mu$ l of air enters pump.

**Action:** Purge pump. See [Section 5.4 Prime inlets and purge pump heads, on page 160](#). If the problem is persistent, see [Remove persistent air bubbles, on page 392](#).

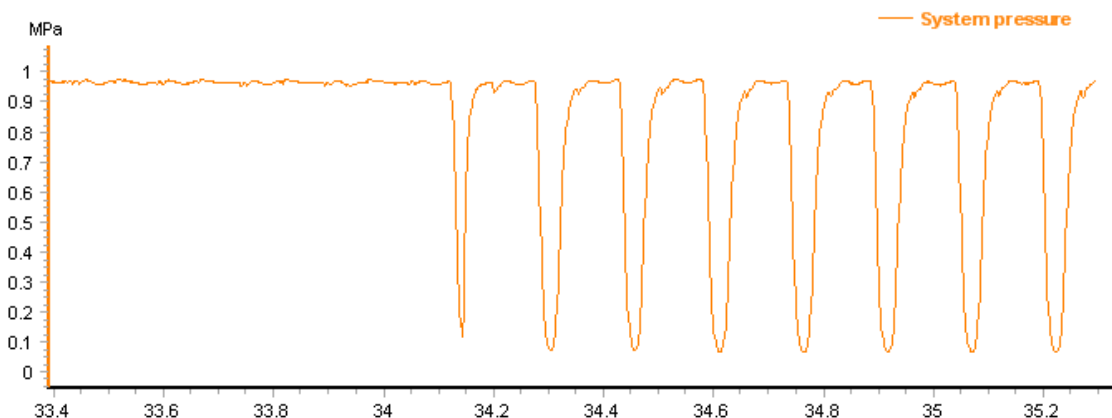

**Incident:** A large volume of air enters pump.

**Action:** Purge pump. See [Section 5.4 Prime inlets and purge pump heads, on page 160](#).

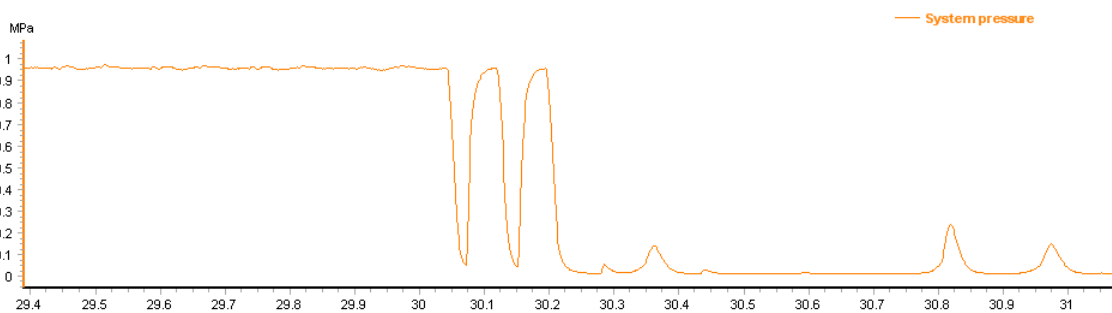

**Incident:** Blocked outlet check valve

**Action:** Clean the check valve, See [Section 7.6.8 Clean the pump head check valves, on page 296](#).

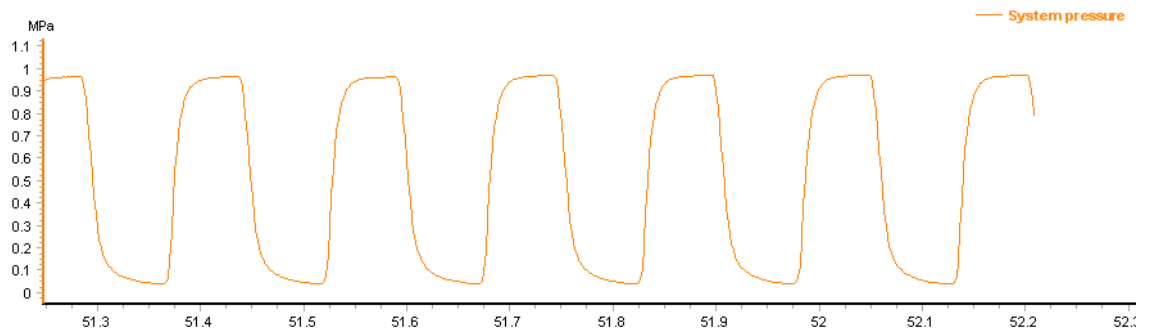

**Incident:** Inlet check valve is loose.

**Action:** Tighten the check valve. See [Section 7.8.9 Replace the pump head check valves, on page 332](#).

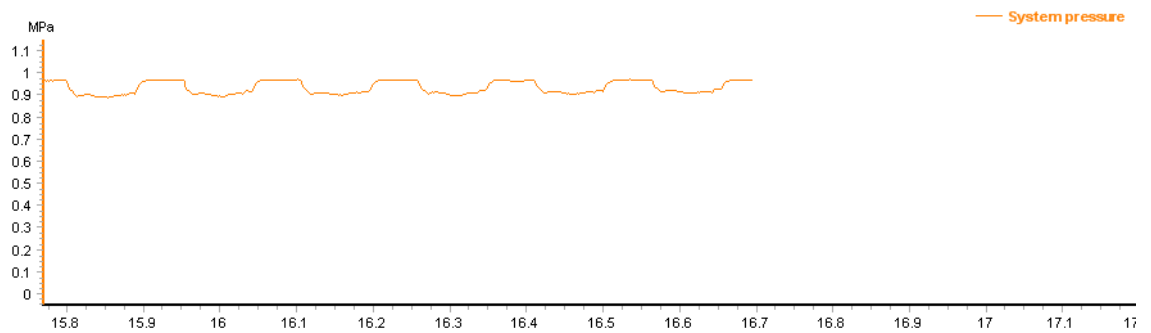

**Incident:** Leaking inlet check valve.

**Action:** Replace the check valve. See [Section 7.8.9 Replace the pump head check valves, on page 332](#).

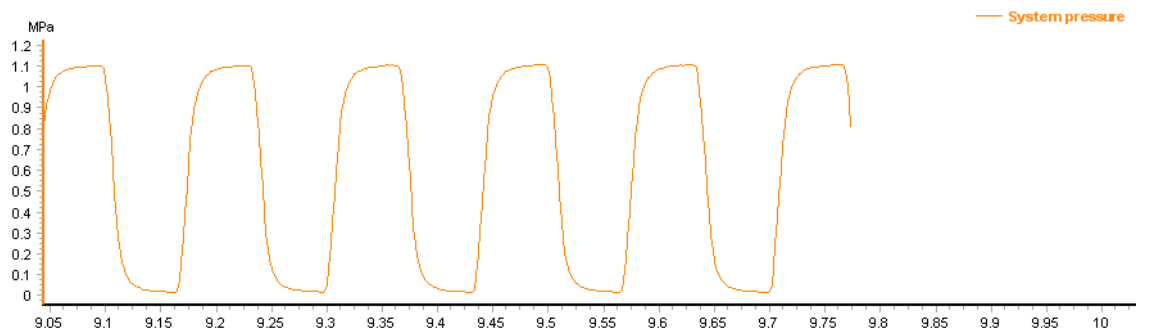

**Incident:** Leaking outlet check valve.

**Actions:** Replace the check valve. See [Section 7.8.9 Replace the pump head check valves, on page 332](#).

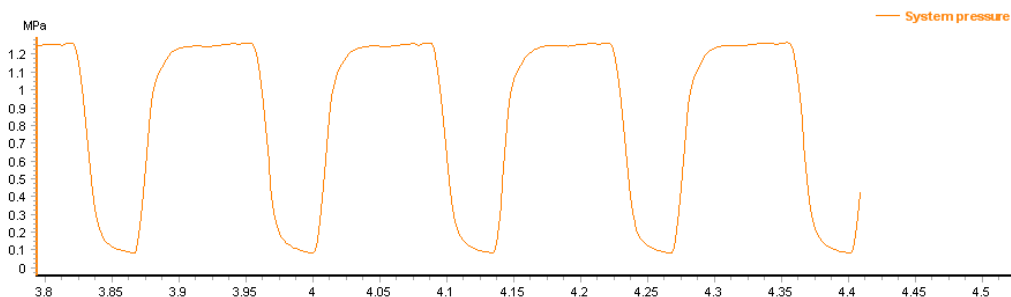

**Incident:** One inlet is blocked,

**Action:** Clean inlet tubing. For example, perform a System CIP.

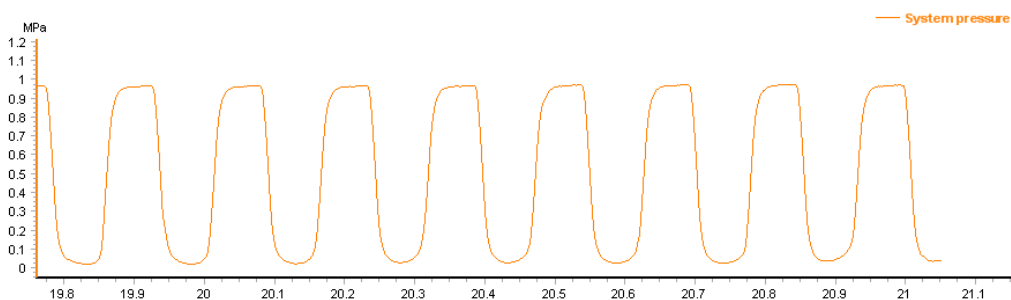

## Remove persistent air bubbles

After purging the pump (see [Section 5.4 Prime inlets and purge pump heads, on page 160](#)), check that all air bubbles have been removed by analyzing the pre-column pressure curve (see examples above). If the pressure curve indicates that there are still air bubbles present, repeat the purging process. If the problem persists, follow the instructions below to purge the pump with methanol (see [Section 5.4 Prime inlets and purge pump heads, on page 160](#) for detailed instructions for the purge procedure).

- 1 Make sure that the pump contains water.
- 2 Use a syringe to draw 100% methanol into the pump (see [Section 5.4 Prime inlets and purge pump heads, on page 160](#) for details).
- 3 Set the pump flow to 2.5 ml/min for ÄKTA pure 25 or 10 ml/min for ÄKTA pure 150.
- 4 Let the flow run until the disturbances in the pressure curve disappear.
- 5 Remove the methanol:
  - Stop the pump and move the inlet tubing to water. Make sure that no air is introduced into the system.
  - Set the pump flow to 1 ml/min for ÄKTA pure 25 or 5 ml/min for ÄKTA pure 150.
  - Run for 5 minutes.



6 Purge the pump again using an appropriate buffer.

---

## 8.7 Troubleshooting: Other components

### In this section

- General Hardware: All modules
- Mixer
- Superloop
- Cabinet
- Power and ICU
- External air sensors
- I/O-box E9
- Instrument control panel

### General hardware: All modules

Problem	Possible cause and action
<b>Modules cannot be found by the instrument</b>	<ul style="list-style-type: none"><li>• <b>The cable between a module and the ICU is not connected</b> Remove the module and make sure that the cable is connected.</li><li>• <b>Two similar modules have been added to the instrument, for example two Inlet valve A</b> Remove one of the modules with the same Node ID.</li><li>• <b>The Node ID for one or more of the modules is incorrect, for example an Inlet valve A2 has the same Node ID as Inlet valve A. The instrument then considers them to have the same identity.</b> Remove Inlet valve A2 and change the Node ID according to <a href="#">Section 9.16 Node IDs, on page 502</a>.</li></ul>
<b>An unknown instrument module is connected to the system</b>	<ul style="list-style-type: none"><li>• <b>The Node ID for one or more of the modules is incorrect</b> Check Node ID and change the Node ID according to <a href="#">Section 9.16 Node IDs, on page 502</a>.</li></ul>

## Mixer

Problem	Possible cause and action
<p><b>Leakage</b></p>	<ul style="list-style-type: none"> <li> <b>Leaking tubing connections</b>            Check the tubing connections. Tighten or replace if necessary. Check the O-ring. Replace it if it is damaged. See <a href="#">Section 7.8.4 Replace the O-ring inside the Mixer, on page 323</a>.            Check the Mixer chamber. Replace it if the liquid has penetrated the Mixer chamber walls and sealings. See <a href="#">Section 7.8.3 Replace the Mixer, on page 322</a>.            See <a href="#">Chapter 10 Ordering information, on page 505</a>.         </li> </ul>
<p><b>Unstable gradients</b></p>	<ul style="list-style-type: none"> <li> <b>Bad mixing of eluents</b>            Check the function of the Mixer. Place a stirrer bar in the palm of your hand. Hold the hand above the Mixer. The stirrer should move when the Mixer is activated.            Check the Mixer chamber size and change chamber if necessary. See <a href="#">Section 7.8.3 Replace the Mixer, on page 322</a>.         </li> </ul>
<p><b>Noisy UV signal</b></p>	<ul style="list-style-type: none"> <li> <b>Bad mixing of eluents</b>            Check the function of the Mixer. Place a stirrer bar in the palm of your hand. Hold the hand above the Mixer. The stirrer should move when the Mixer is activated.            Check the Mixer chamber size and change chamber if necessary, see <a href="#">Select Mixer chamber, on page 151</a>.         </li> </ul>
<p><b>The Mixer chamber was not recognized</b></p>	<ul style="list-style-type: none"> <li> <b>The Mixer chamber is not correctly installed</b>            Verify that the Mixer chamber is correctly installed. See <a href="#">Section 7.8.3 Replace the Mixer, on page 322</a>. If the error is recurrent, replace the Mixer chamber. See <a href="#">Chapter 10 Ordering information, on page 505</a>.         </li> </ul>
<p><b>The internal Mixer temperature is too high</b></p>	<ul style="list-style-type: none"> <li> <b>The air intake on the rear or on the left side of the instrument is covered</b>            Make sure that none of the air intakes on the instrument are covered.         </li> <li> <b>Hot surroundings</b>            Decrease the room temperature. Maximum operating temperature is 35°C.         </li> <li> <b>Hardware error</b>            Switch off the instrument and wait until the temperature has decreased. Restart the instrument. If this error is recurrent, generate a System error report and contact Service.         </li> </ul>

## Superloop

Problem	Possible cause and action
Overpressure during filling	<ul style="list-style-type: none"> <li>• <b>The Superloop is filled to the max. Pressure is not released anywhere.</b> Manually turn Injection valve to <b>Manual load</b> position.</li> </ul>

## Cabinet

Problem	Possible cause and action
The temperature of the instrument or an instrument component is too high	<ul style="list-style-type: none"> <li>• <b>The air intake on the back or on the left side of the instrument is covered</b> Make sure that none of the air intakes on the instrument are covered.</li> <li>• <b>Broken fans</b> Contact Service.</li> <li>• <b>Hot surroundings</b> Decrease the room temperature. Maximum operating temperature is 35°C.</li> </ul>
Liquid from the Buffer tray is flowing onto the table	<ul style="list-style-type: none"> <li>• <b>The waste tubing from the Buffer tray is loose</b> Contact Service.</li> </ul>

## Power and ICU

Problem	Possible cause and action
The instrument cannot be turned on	<ul style="list-style-type: none"> <li>• <b>The power cord is not connected</b> Connect the power cord to the wall outlet and to the electrical inlet on the instrument. Make sure that the cord is attached using the clip, thereby preventing the cord from coming loose.</li> <li>• <b>No electric current in the wall outlet</b> Make sure that there is electric current in the wall outlet.</li> <li>• <b>A fuse in the instrument ICU is broken</b> Contact Service.</li> <li>• <b>The instrument is overheated</b> Switch off the instrument and wait until the temperature has decreased. Restart the instrument. If this error is recurrent, generate a System error report and contact Service.</li> </ul>

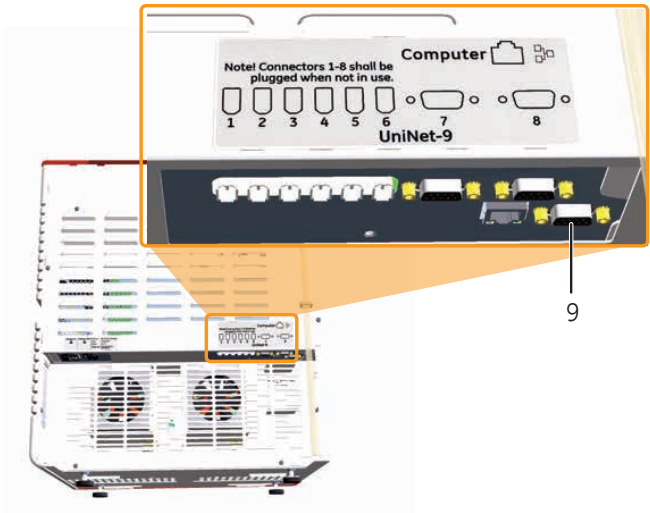
Problem	Possible cause and action
<p><b>One or more modules are automatically turned off</b></p>	<ul style="list-style-type: none"> <li>• <b>One or some of the minor modules use too much current. Minor modules include all modules except the Fraction collector, the UV monitor and the pumps.</b></li> </ul> <p>The current is cut off by a temperature sensitive component. The instrument can be restarted when the temperature has decreased. If persistent, generate a System error report and contact Service.</p>
<p><b>The instrument cannot be seen in UNICORN</b></p>	<ul style="list-style-type: none"> <li>• <b>The network cable is not connected</b></li> </ul> <p>Connect the cable, see UNICORN Administration and Technical Manual.</p>
<p><b>One or more module(s) is not found by the instrument</b></p>	<ul style="list-style-type: none"> <li>• <b>The cable between a module and the ICU is not connected.</b></li> </ul> <p>Remove valves and check that cables are connected.</p> <ul style="list-style-type: none"> <li>• <b>One or more jumpers are loose or missing.</b></li> </ul> <p>Check the connections on the back of the instrument. Empty positions for UniNet-9 connectors 1 to 8 must have connected jumpers. See the illustration below. The connector 9 should be protected with a plastic lid and must never have a jumper connected to it.</p> 

Problem	Possible cause and action
<b>The internal instrument temperature is too high</b>	<ul style="list-style-type: none"> <li>• <b>The air intake at the rear or on the right side of the instrument is covered</b> Make sure that none of the air intakes on the instrument are covered.</li> <li>• <b>Hot surroundings</b> Decrease the room temperature. Maximum operating temperature is 35°C.</li> <li>• <b>Hardware error</b> Switch off the instrument and wait until the temperature has decreased. Restart the instrument. If this error is recurrent, generate a System error report and contact Service.</li> </ul>

## External air sensors

Problem	Possible cause and action
<b>The external air sensor is not found by the instrument</b>	<ul style="list-style-type: none"> <li>• <b>The cable between the external air sensor and the ICU is not connected</b> Check the back of the instrument and make sure that the cable is connected.</li> <li>• <b>The external air sensor has not been selected in UNICORN</b> Select the external air sensor in UNICORN. Refer to the installation instructions delivered together with the external air sensor.</li> </ul>
<b>Air is introduced into the flow path</b>	<ul style="list-style-type: none"> <li>• <b>One of the connections is not tight enough</b> Tighten the connectors.</li> </ul>
<b>Liquid is leaking from the external air sensor</b>	<ul style="list-style-type: none"> <li>• <b>One of the connections is not tight enough</b> Tighten the connectors.</li> </ul>
<b>The internal temperature of the air sensor is too high</b>	<ul style="list-style-type: none"> <li>• <b>Hot surroundings</b> Decrease the room temperature. Maximum operating temperature is 35°C.</li> <li>• <b>Hardware error</b> Switch off the instrument and wait until the temperature has decreased. Restart the instrument. If this error is recurrent, generate a System error report and contact Service.</li> </ul>

## I/O-box E9

Problem	Possible cause and action
The internal temperature of the I/O-box is too high	<ul style="list-style-type: none"> <li>• <b>Hot surroundings</b> Decrease the room temperature. Maximum operating temperature is 35 C.</li> <li>• <b>Hardware error</b></li> </ul>
The I/O-box is not detected by the system	<ul style="list-style-type: none"> <li>• <b>Wrong Node ID</b> Make sure that the Node ID is (00) for the primary box, and (01) for a potential secondary box.</li> </ul>
The system does not detect Digital signals correctly	<ul style="list-style-type: none"> <li>• <b>Cables incorrectly connected</b> Make sure that the cables are connected correctly, earth to earth etc.</li> </ul>
Digital In always "0", regardless of input signals	<ul style="list-style-type: none"> <li>• <b>Digital Out connections switched</b> Check that the digital Out cables are correctly connected, earth to earth etc.</li> </ul>
External digital equipment does not respond to set changes in Digital Out	<ul style="list-style-type: none"> <li>• <b>Cables incorrectly connected</b> Make sure that the cables are connected correctly, earth to earth etc. To isolate the problem: <ol style="list-style-type: none"> <li>1 Connect Digital Out (e.g. pin 6) to Digital In (pin 1,2,3, or 4).</li> <li>2 Change the Digital Out 1 signal between "1" and "0". Verify that Digital out follows.</li> <li>3 If not: contact Service. If it does: the problem probably lies within the connected equipment.</li> </ol> </li> </ul>
Analog In does not measure expected voltage	<ul style="list-style-type: none"> <li>• <b>Auto-zero on the wrong level</b> Reset Auto-zero.</li> <li>• <b>Digital Out connection error</b> Make sure that Digital Out is connected correctly, earth to earth etc.</li> </ul>
Noisy analog signal	<ul style="list-style-type: none"> <li>• <b>Too long cable between the external equipment and E9</b> Use as short cable as possible. Use shielded cable. Connect the cable shield to the D-sub connector's shield.</li> </ul>
Analog In does not measure expected voltage	<ul style="list-style-type: none"> <li>• <b>Analog In is not calibrated</b> Contact Service.</li> </ul>

Problem	Possible cause and action
Analog Out does not generate expected voltage	<ul style="list-style-type: none"> <li>• <b>Analog Out is not calibrated</b> Contact Service.</li> </ul>

## Instrument control panel

Problem	Possible cause and action
The internal temperature of the instrument control panel is too high	<ul style="list-style-type: none"> <li>• <b>The air intake on the rear or on the right side of the instrument is covered.</b> Make sure that none of the air intakes of the instrument are covered.</li> <li>• <b>Hot surroundings</b> Decrease the room temperature. Maximum operating temperature is 35 C.</li> <li>• <b>Hardware error</b> Switch off the instrument and wait until the temperature has decreased. Restart the instrument. If this error is recurrent, generate a System error report and contact Service.</li> </ul>



## 8.8 Troubleshooting: Instrument communication

Scenario	Possible cause and action
<p><b>Multiple error messages in UNICORN: <i>Lost modules</i></b></p>	<ul style="list-style-type: none"> <li>• <b>A cable to a module (including Module Panels) is not connected</b> Connect the cable:               <ol style="list-style-type: none"> <li>1 Switch off the instrument.</li> <li>2 Check all modules and connections.</li> <li>3 Switch on the instrument.</li> <li>4 In the displayed dialog in UNICORN, select the option <b>Restart the system only</b> and click <b>OK</b>.</li> </ol> </li> <li>• <b>A UniNet-9 connector is not plugged</b> Check that all <b>UniNet-9</b> connectors that are not in use are plugged.</li> </ul>
<p><b>UNICORN has lost communication with the instrument server</b></p>	<ul style="list-style-type: none"> <li>• <b>The UNICORN client has lost connection to the instrument server during a temporary overload of the processor</b> Restart the UNICORN client to regain control. The run continues and no data will be lost.</li> </ul>
<p><b>Warning message in UNICORN: <i>Instrument module is missing</i></b></p>	<ul style="list-style-type: none"> <li>• <b>The module is not functioning properly</b> In the displayed dialog in UNICORN, select the option <b>Restart the system only</b> and click <b>OK</b>. If the problem still remains, replace the module or contact Service.</li> </ul>
<p><b>Warning messages in UNICORN: <i>(Warning) Two instrument modules have the same Node ID</i></b></p>	<ul style="list-style-type: none"> <li>• <b>Two or several modules have the same Node ID</b> Change to correct Node IDs:               <ol style="list-style-type: none"> <li>1 Switch off the instrument.</li> <li>2 Check the Node ID for all modules, see <a href="#">Section 9.16 Node IDs, on page 502</a>.</li> <li>3 Switch on the instrument.</li> <li>4 In the displayed dialog in UNICORN, select the option <b>Restart the system only</b> and click <b>OK</b>.</li> </ol> </li> </ul>

Scenario	Possible cause and action
<b>Warning messages in UNICORN: (Warning) Gate (12): Internal instrument error</b>	<ul style="list-style-type: none"><li>• <b>One module has an incorrect Node ID</b> Change the Node ID:<ol style="list-style-type: none"><li>1 Switch off the instrument.</li><li>2 Check the Node ID for all modules, see <a href="#">Section 9.16 Node IDs, on page 502</a>.</li><li>3 Switch on the instrument.</li><li>4 In the displayed dialog in UNICORN, select the option <b>Restart the system only</b> and click <b>OK</b>.</li></ol></li></ul>

## 8.9 Troubleshooting: Method development

Scenario	Possible cause and action
<p>Phase properties or text instructions are not available in the method editor as expected</p>	<ul style="list-style-type: none"> <li>• <b>The module required for the instruction has not been enabled in the component selection in the administration module</b> Review the component list.</li> <li>• <b>The wrong system has been selected when creating the new method</b> Make sure that the right system has been selected in the "new method" dialog.</li> </ul>
<p>A method has been created for a system that now has a different configuration</p>	<ul style="list-style-type: none"> <li>• <b>Action:</b> <ol style="list-style-type: none"> <li>1 Open the method in the method editor.</li> <li>2 Select to either adapt the method to the new configuration <i>OR</i> Keep the text method unchanged and manually replace the text instructions that are not available for the new configuration.</li> </ol> <p>Refer to <a href="#">Open and save methods for different systems, on page 214</a> for more information.</p> </li> </ul>
<p>An old method is to be transferred to a new system configuration.</p>	<ul style="list-style-type: none"> <li>• <b>Action:</b> <ol style="list-style-type: none"> <li>1 Open the method in the method editor.</li> <li>2 Save as and select the new system. <i>OR</i> If the configuration is different on the new system, select to either adapt the method to the new configuration or to keep the text method unchanged and manually replace the text instructions that are not available.</li> </ol> <p>Refer to <a href="#">Open and save methods for different systems, on page 214</a> for more information.</p> </li> </ul>

## 8.10 Error codes

### Introduction

This section describes the error codes that can appear for the different modules, together with corrective actions.

### All modules

Error code	Description	Action
0 - 19	Internal instrument error	Restart the instrument. If recurrent please contact Service.

### Instrument control unit

Error code	Description	Action
21 - 69	Internal instrument error	Restart the instrument. If recurrent please contact Service.

### Valve

Error code	Description	Action
20, 24	Internal instrument error	Restart the instrument. If recurrent please contact Service.
22	Valve not finding position	Restart the instrument. If recurrent please contact Service.
23	Faulty air sensor	Restart the instrument. If recurrent please contact Service.
25	High temperature	See <a href="#">Section 8.4 Troubleshooting: Valves, on page 375</a>

### Pressure monitor

Error code	Description	Action
20, 21, 24-27	Internal instrument error	Restart the instrument. If recurrent please contact Service.
23	High temperature	See <a href="#">Pressure monitors, on page 372</a> .

## Air sensor

Error code	Description	Action
20	High temperature	See <a href="#">External air sensors, on page 398</a> .

## Mixer

Error code	Description	Action
25	Mixer motor error	Restart the instrument. If recurrent please contact Service.
26	Internal instrument error	Restart the instrument. If recurrent please contact Service.
27	High temperature	See <a href="#">Mixer, on page 395</a>

## pH monitor

Error code	Description	Action
20, 21	Internal instrument error	Restart the instrument. If recurrent please contact Service.
25	No factory calibration	Contact Service
26	High temperature	See <a href="#">pH monitor and pH valve, on page 370</a> .

## Conductivity monitor

Error code	Description	Action
20-27	Internal instrument error	Restart the instrument. If recurrent please contact Service.
28	High temperature	See <a href="#">Conductivity monitor, on page 367</a>
29	Temperature data error	Restart the instrument. If recurrent please contact Service.
32-34	No factory calibration	Contact Service

## Pump

Error code	Description	Action
51-53	Internal pump error	Check that there is no blockage of the pump outlet. Restart the instrument. If recurrent please contact Service.
54	High temperature	See <a href="#">Section 8.6 Troubleshooting: Pumps, on page 387</a>

## UV monitor U9-M

Error code	Description	Action
21, 25, 26, 31	Grating error	Restart the instrument. If recurrent please contact Service.
22, 23, 32	Block filter error	Restart the instrument. If recurrent please contact Service.
24	Internal instrument error	Restart the instrument. If recurrent please contact Service.
27	Spectrum calibration error	Restart the instrument. If recurrent please contact Service.
28, 29	Lamp error	Restart the instrument. If recurrent please contact Service.
30	High temperature	See <a href="#">UV monitor U9-M and UV detector unit, on page 360</a> .

## UV detector U9-D

Error code	Description	Action
24, 26, 28, 29, 31, 33	Internal instrument error	Restart the instrument. If recurrent please contact Service.
25	Too low light intensity	Check that the detector and flow cell are fitted correctly. If warning reappears, contact Service.
27	Too high light intensity	Check that the detector and flow cell are fitted correctly. If warning reappears, contact Service.
30	Too high light intensity, R channel	Check that the detector is fitted correctly. If warning reappears, contact Service.

Error code	Description	Action
32	Too high S light intensity, S channel	Check that the flow cell is fitted correctly. If warning reappears, contact Service.
34	No light detected	Check optical pathway and restart the instrument. If recurrent please contact Service.
35	Too low light intensity, R channel	Check that the detector is fitted correctly. If warning reappears, contact Service.
36	Too low light intensity, S channel	No light through flow cell. Check solution absorption and that the cell is fitted correctly.

## UV monitor U9-L

Error code	Description	Action
51	High temperature	See <a href="#">UV monitor U9-L, on page 364</a> .
52, 55	Low lamp intensity	Contact Service.
54	Autozero out of range	Autozero requested when AU value is larger than 2.
58	Too low light intensity, S channel	No light through flow cell. Check solution absorption and that the cell is fitted correctly.
59, 60	Internal instrument error	Restart the instrument. If recurrent please contact Service.
61	Measurement error	Restart the instrument. If recurrent please contact Service.

## Fraction collector F9-C

Error code	Description	Action
20 - 22	Internal instrument error.	Restart the fraction collector with the power switch on the ÄKTA pure instrument. If recurrent, generate a system error report and contact service.
32	The fraction collector failed to operate the accumulator.	Restart the fraction collector with the power switch on the ÄKTA pure instrument. If recurrent, generate a system error report and contact service.

Error code	Description	Action
33 - 35, 37 - 40, 55	Fraction collector configuration error.	The instrument restarts. If the error is recurrent, generate a system error report and contact service.
47 - 48	The fraction collector failed to detect the code on the cassette or the type of plate.	Clean the cassette code reader, the cassette type code on the cassette and the plate.
53	Calibration of the dropsync sensor failed.	Clean the Drop sync sensor, see user documentation for the location of the sensor. If this error is recurrent, please contact service.
54	Fraction collector movement is blocked. Either the door is open or there are communication problems.	Close the door of the fraction collector.
57 - 59	Internal fraction collector error.	The instrument restarts. If the error is recurrent, generate a system error report and contact service.
63	Tube change is too fast.	Lower the flow rate or increase the fractionation volume.
68, 72	Fraction collector arm movement is blocked.	The instrument restarts. If the error is recurrent, generate a system error report and contact service.

## Fraction collector F9-R

Error code	Description	Action
20	High temperature	See <a href="#">Section 8.5 Troubleshooting: Fraction collector, on page 377</a>
21	Drop sync warning	Clean the sensor and remove air bubbles in the flow path.
22	Tube sensor error	Check that the tube sensor is adjusted properly.
23	Delay queue full	Increase the fraction size. Fraction size must be greater than 1/10 of the delay volume.
24, 26	Internal instrument error	Restart the instrument. If recurrent please contact Service.
25, 28	Too fast tube change	Increase the fraction size or lower the flow rate.



Error code	Description	Action
27	Drop sync error	Clean the drop sensor Error code

## Instrument control panel

Error code	Description	Action
51	High temperature	See <i>Instrument control panel, on page 400</i>

## I/O-box

Error code	Description	Action
20	High temperature	See section "Troubleshooting"
21	Analog in signal below -2V	Check the external equipment connected to the I/O-box.
22	Analog in signal above 2V	Check the external equipment connected to the I/O-box.
23-28	Internal instrument error	Restart the instrument. If recurrent please contact Service.

# 9 Reference information

## About this chapter

This chapter lists the allowed environmental and operational ranges for ÄKTA pure. Refer to *ÄKTA pure Product Documentation* for detailed technical specifications.

---

## In this chapter

This chapter contains the following sections:

Section	See page
9.1 System specifications	411
9.2 Module specifications	413
9.3 Tubing and connectors	420
9.4 Recommended tubing kits for prepacked columns	428
9.5 Chemical resistance guide	431
9.6 Wetted materials	436
9.7 Predefined methods and phases	438
9.8 System settings	448
9.9 Manual instructions	465
9.10 Available Run data	487
9.11 Available Curves	490
9.12 Injection volumes and peak broadening	492
9.13 Delay volumes	493
9.14 Component volumes	498
9.15 Pressure control	500
9.16 Node IDs	502

---

## 9.1 System specifications

### System specifications

Parameter	Data
System configuration	Benchtop system, external computer
Control system	UNICORN 6.3 or other compatible version
Connection between PC and instrument	Ethernet
Dimensions (W x D x H)	535 x 470 x 630 mm
Weight (excluding computer)	up to 53 kg
Power supply	100-240 V ~, 50-60 Hz
Power consumption	300 VA (typical) 25 VA (power-save)
Enclosure protective class	IP 21
Tubing and connectors	<p>ÄKTA pure 25:</p> <ul style="list-style-type: none"> <li>• Inlet: FEP tubing, i.d. 1.6 mm, Tubing connector 5/16" + Ferrule (yellow), 1/8"</li> <li>• Pump to Injection valve: PEEK tubing, i.d. 0.75 mm, Fingertight connector, 1/16"</li> <li>• After Injection valve: PEEK tubing, i.d. 0.50 mm, Fingertight connector, 1/16"</li> <li>• Outlet and waste: ETFE tubing, i.d. 1.0 mm, Fingertight connector, 1/16"</li> <li>• Optional tubing kits: i.d. 0.25 mm, i.d. 0.75 mm, i.d. 1.0 mm</li> </ul>

Parameter	Data
Tubing and connectors	<p>ÄKTA pure 150:</p> <ul style="list-style-type: none"> <li>• Inlet: FEP tubing, i.d. 2.9 mm, Tubing connector 5/16" + Ferrule (blue), 3/16"</li> <li>• Pump to injection valve: PEEK tubing, i.d. 1.0 mm, 10-32 UNF connections</li> <li>• After Injection valve: PEEK tubing, i.d. 0.75 mm, 10-32 UNF connections</li> <li>• Outlet: FEP, i.d. 1.6 mm, 5/16-24 UNF connections</li> <li>• Waste: ETFE tubing, i.d. 1.0 mm, Fingertight connector, 1/16"</li> <li>• Optional tubing kits: i.d. 0.5 mm, i.d. 1.0 mm</li> </ul>

## Environmental ranges

Parameter	Data
Storage and transport temperature range	-25°C to +60°C
Chemical environment	See the relevant purification instrument <i>User manual</i> .

## Operating ranges

Parameter	Data
Operating temperature range	4°C to 35°C
Relative humidity	20% to 95%, non-condensing

## Equipment noise level

Equipment	Acoustic noise level
ÄKTA pure instrument	< 60 dB A

## 9.2 Module specifications

### Introduction

This section specifies the operating data of the components in ÄKTA pure. For general data for the system see [System specifications, on page 411](#).

### System pumps

Parameter	Data
Pump type	Piston pump, metering type
Flow rate range	<p>ÄKTA pure 25: 0.001 to 25 ml/min (up to 50 ml/min during column packing)</p> <p>ÄKTA pure 150: 0.01 to 150 ml/min (up to 300 ml/min during column packing)</p>
Pressure range	<p>ÄKTA pure 25: 0 to 20 MPa (2900 psi)</p> <p>ÄKTA pure 150: 0 to 5 MPa (725 psi)</p>
Viscosity range	<p>ÄKTA pure 25: 0.35 to 10 cP (5 cP above 12.5 ml/min)</p> <p>ÄKTA pure 150: 0.35 to 5 cP</p>
Flow rate specifications	<p>ÄKTA pure 25:</p> <ul style="list-style-type: none"> <li>• Accuracy: <math>\pm 1.2\%</math></li> <li>• Precision: RSD &lt; 0.5%</li> </ul> <p>(Conditions: 0.25 to 25 ml/min, &lt; 3 MPa, 0.8 to 2 cP)</p> <p>ÄKTA pure 150:</p> <ul style="list-style-type: none"> <li>• Accuracy: <math>\pm 1.5\%</math></li> <li>• Precision: RSD &lt; 0.5%</li> </ul> <p>(Conditions: 1.0 to 150 ml/min, &lt; 3 MPa, 0.8 to 2 cP)</p>

## Sample pump

Parameter	Data
Pump type	Piston pump, metering type
Dimensions (W x D x H)	215 x 370 x 210 mm
Weight	11 kg
Flow rate range	ÄKTA pure 25: 0.001 – 50 ml/min ÄKTA pure 150: 0.01 to 150 ml/min
Pressure range	ÄKTA pure 25: 0 to 10 MPa (1450 psi) ÄKTA pure 150: 0 to 5 MPa (725 psi)
Viscosity range	0.7 to 10 cP
Flow rate specifications	ÄKTA pure 25: <ul style="list-style-type: none"> <li>• Accuracy: <math>\pm 2\%</math></li> <li>• Precision: RSD &lt; 0.5%</li> </ul> (Conditions: 0.25 – 50 ml/min, < 3 MPa, 0.8 – 3 cP) ÄKTA pure 150: <ul style="list-style-type: none"> <li>• Accuracy: <math>\pm 2\%</math></li> <li>• Precision: RSD &lt; 0.5%</li> </ul> (Conditions: 1.0 – 150 ml/min, < 3 MPa, 0.8 – 3 cP)

## Valves

Parameter	Data
Type	Rotary valves
Number of valves	Up to 12
Functions	Standard: Injection Options: Inlet A, Inlet B, Sample inlet, Extra inlet, Mixer bypass, Loop selection, Column selection, pH, Outlet, Versatile

## Inlet options

Parameter	Data
Inlet A	1, 2 or 7 inlets
Inlet B	1, 2 or 7 inlets
Sample inlet	Up to 7 sample inlets and 1 buffer inlet

## Outlet options

Parameter	Data
Number of outlets	1 or 10

## Mixer

Parameter	Data
Mixing principle	Chamber with magnetic stirrer
Mixer volume	ÄKTA pure 25: 0.6, 1.4 or 5 ml ÄKTA pure 150: 1.4, 5 or 15 ml

## Gradient formation

Parameter	Data
Gradient flow rate range	ÄKTA pure 25: 0.1 to 25 ml/min ÄKTA pure 150: 0.5 to 150 ml/min
Gradient composition accuracy	ÄKTA pure 25: ±0.6% (Conditions 5 to 95% B. 0.5 to 25 ml/min, 0.2 to 2 MPa, 0.8 to 2 cP) ÄKTA pure 150: ±0.8% (Conditions 5 to 95% B. 2 to 150 ml/min, 0.2 to 2 MPa, 0.8 to 2 cP)

## Pressure monitors

Parameter	Data
Number of sensors	Up to 4
Placement of sensors	<p>Standard: The System pressure monitor is located after the System pump</p> <p>Options:</p> <ul style="list-style-type: none"> <li>The Pre-column pressure monitor and the Post-column pressure monitor are integrated in Column valve <b>V9-C</b> or <b>V9H-C</b>.</li> <li>The Sample pressure monitor is located after the Sample pump.</li> </ul>

## External air sensor options

Parameter	Data
Number of sensors	Up to 7
Placement	<ul style="list-style-type: none"> <li>Integrated in inlet valve A, inlet valve B and sample inlet valve</li> <li>After the injection valve</li> <li>Before the system pumps</li> <li>Before the sample pump</li> </ul>
Sensing principle	Ultrasonic

## UV monitor options

Parameter	Data
Number of monitors	Up to 2
Wavelength range	<p><b>U9-L:</b> 280 nm</p> <p><b>U9-M:</b> 190 to 700 nm in steps of 1 nm, up to 3 wavelengths</p>
Absorbance range	-6 to 6 AU
Resolution	0.001 mAU
Linearity	<p><b>U9-L:</b> within <math>\pm 5\%</math> at 0 to 2 AU</p> <p><b>U9-M:</b> within <math>\pm 2\%</math> at 0 to 2 AU</p>
Drift	<p><b>U9-L</b> (2 mm cell): <math>\leq  0.2 \text{ mAU}   \text{ AU/h}</math></p> <p><b>U9-M</b> (2 mm cell at 280 nm): <math>\leq  0.2 \text{ mAU}   \text{ AU/h}</math></p>



Parameter	Data
Noise	<b>U9-L:</b> < 0.1 mAU <b>U9-M:</b> < 0.08 mAU
Operating pressure	0 to 2 MPa
Lamp operating time	<b>U9-L:</b> > 10000 h <b>U9-M:</b> > 5000 h
Flow cells: <b>U9-L</b>	Standard: Optical path length 2 mm Cell volume 2 $\mu$ l Total volume: 30 $\mu$ l Option: Optical path length 5 mm Cell volume 6 $\mu$ l Total volume 20 $\mu$ l
Flow cells: <b>U9-M</b>	Standard: Optical path length 2 mm Cell volume 2 $\mu$ l Total volume: 11 $\mu$ l Option: Optical path length 10 mm Cell volume 8 $\mu$ l Total volume 12 $\mu$ l Optical path length 0.5 mm Cell volume 1 $\mu$ l Total volume 10 $\mu$ l

## Conductivity monitor options

Parameter	Data
Conductivity reading range	0.01 to 999.99 mS/cm
Accuracy	$\pm 0.01$ mS/cm or $\pm 2\%$ , whichever is greater, (within 0.3 to 300 mS/cm)
Operating pressure	0 to 5 MPa
Flow cell volume	22 $\mu$ l
Temperature monitor range	0°C to 99°C
Temperature monitor accuracy	$\pm 1.5^\circ\text{C}$ within $4^\circ\text{C}$ to $45^\circ\text{C}$

## pH monitor option

Parameter	Data
pH reading range	0 to 14
Accuracy	± 0.1 pH unit within pH 2 to 12, temperature within ±3°C from calibration temperature
Operating pressure	0 to 0.5 MPa
Flow cell volume	ÄKTA pure 25: 76 µl ÄKTA pure 150: 129 µl

## Outlet valve fractionation option

Parameter	Data
Number of outlets	10
Fraction volumes	0.01 to 20 000 ml
Delay volume (UV – outlet valve)	ÄKTA pure 25: 125 µl 66 µl with optional tubing kit (i.d. 0.25 mm) ÄKTA pure 150: 296 µl 245 µl with optional tubing kit (i.d. 0.5 mm)

## Fraction collector options

Parameter	Data
Number of fraction collectors	Up to two. The second fraction collector must be an F9-R.
Number of fractions	F9-C: Up to 576 F9-R: Up to 175

Parameter	Data
Vessel types	F9-C: <ul style="list-style-type: none"> <li>• Deep well plates, 96, 48 or 24 wells</li> <li>• Tubes 3, 5, 8, 15, 50 ml</li> <li>• Bottle, 250 ml</li> </ul> F9-R: 3, 5, 8, 15 or 50 ml tubes
Fraction volumes	F9-C: 0.1 to 250 ml F9-R: 0.1 to 50 ml
Spillage-free mode	F9-C: Automatic, Drop sync or Accumulator F9-R: Drop sync
Flammable liquids	F9-C: no F9-R: yes
Delay volume (UV – dispenser head)	ÄKTA pure 25: F9-R: 205 µl, 86 µl with optional tubing kit (i.d. 0.25 mm) F9-C: 435 µl, 214 µl with optional tubing kit (i.d. 0.25 mm) ÄKTA pure 150: F9-R: 473 µl, 278 µl with optional tubing kit (i.d. 0.5 mm) F9-C: 876 µl, 508 µl with optional tubing kit (i.d. 0.5 mm)
Dimensions (W x D x H)	<ul style="list-style-type: none"> <li>• F9-C: 390 x 585 x 320 mm</li> <li>• F9-R: 320 x 400 x 250 mm</li> </ul>
Weight	<ul style="list-style-type: none"> <li>• F9-C: 21 kg</li> <li>• F9-R: 5 kg</li> </ul>

## I/O box

Parameter	Data
Number of ports	2 analog in, 2 analog out 4 digital in, 4 digital out
Analog range	In +/- 2 V Out +/- 1 V

## 9.3 Tubing and connectors

### Tubing types

The table below shows the tubing types used in ÄKTA pure.

Description	Color	Scope of use	Volume/cm
PEEK, o.d. 1/16", i.d. 0.25 mm	Blue	High pressure tubing Reference capillary 1 Tubing Kit 0.25	0.5 µl
PEEK, o.d. 1/16", i.d. 0.50 mm	Orange	High pressure tubing Tubing kit 0.5 (standard)	2.0 µl
PEEK, o.d. 1/16", i.d. 0.75 mm	Green	High pressure tubing Tubing kit 0.75	4.4 µl
PEEK, o.d. 1/16", i.d. 1.0 mm	Beige	High pressure tubing Tubing kit 1.0	7.8 µl
FEP, o.d. 1/8", i.d. 1.6 mm	Transparent	Inlet tubing	20.0 µl
FEP, o.d. 3/16", i.d. 2.9 mm	Transparent	Inlet tubing for high flow rate and high viscosity	66.0 µl
ETFE, o.d. 1/16", i.d. 0.75 mm	Transparent	Narrow inlet tubing (optional)	4.4 µl
ETFE, o.d. 1/16", i.d. 1.0 mm	Transparent	Outlet and waste tubing	7.8 µl
Silicone, o.d. 12 mm, i.d. 8 mm	Transparent	Waste tubing from Buffer tray	0.3 ml
		Pump rinse solution tubing	

- Note:**
- Many different sizes/types of tubing can be connected to a chromatography system. Tubing with a smaller inner diameter (i.d.) holds less delay volume and will therefore generate less dilution of the protein peak. Narrow tubing, however, increases the system pressure, especially when running at high flow rates. The tubing used should match the application needs. See [Section 9.4 Recommended tubing kits for prepacked columns, on page 428](#) for more information.
  - When using the high pressure tubing kit with i.d. 1.0 mm to allow high flow rates in combination with high viscosities in the pumps, inlet tubing with a larger i.d. than standard might be needed to avoid outgassing.

## Tubing connectors

The table below shows the tubing connectors used in ÄKTA pure.

Description	Use with tubing...
Fingertight connector, 1/16"	<ul style="list-style-type: none"> <li>• PEEK, o.d. 1/16", i.d. 0.25 mm</li> <li>• PEEK, o.d. 1/16", i.d. 0.50 mm</li> <li>• PEEK, o.d. 1/16", i.d. 0.75 mm</li> <li>• PEEK, o.d. 1/16", i.d. 1.0 mm</li> <li>• ETFE, o.d. 1/16", i.d. 1.0 mm</li> </ul>
Tubing connector 5/16" + Ferrule (blue), 1/16"	ETFE, o.d. 1/16", i.d. 0.75 mm
Tubing connector 5/16" + ferrule (blue) 3/16"	FEP o.d. 3/16" i.d. 2.9 mm
Tubing connector 5/16" + Ferrule (yellow), 1/8"	FEP, o.d. 1/8", i.d. 1.6 mm

## Other connectors

The table below shows other connectors used in ÄKTA pure.

Description	Scope of use
Stop plug 1/16"	Stop plug for valve ports
Luer female	Syringe connector for pH valve and Injection valve

## Tubing labels

The illustration below shows the tubing labels for for a typical system configuration.

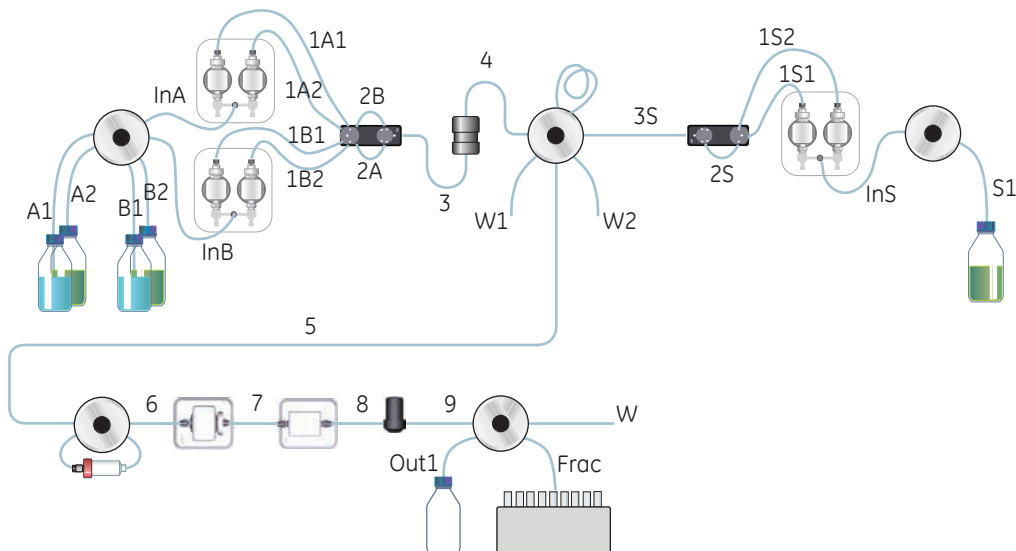

## Inlet tubing

The table below shows the labels, standard diameters, and standard lengths of the inlet tubing.

Label	Description	Tubing		Length (mm)	Volume (ml)	
		ÄKTA pure 25	ÄKTA pure 150		ÄKTA pure 25	ÄKTA pure 150
<b>A1-A2</b> and <b>B1-B2</b>	Inlets to Inlet valve AB	FEP, o.d. 1/8", i.d. 1.6 mm	FEP, o.d. 3/16", i.d. 2.9 mm	1500	3.0	9.9
<b>A1-A7</b>	Inlets to Inlet valve A	FEP, o.d. 1/8", i.d. 1.6 mm	FEP, o.d. 3/16", i.d. 2.9 mm	1500	3.0	9.9
<b>B1-B7</b>	Inlets to Inlet valve B	FEP, o.d. 1/8", i.d. 1.6 mm	FEP, o.d. 3/16", i.d. 2.9 mm	1500	3.0	9.9
<b>InA</b>	From Inlet valve A or Inlet valve AB to System pump A	FEP, o.d. 1/8", i.d. 1.6 mm	FEP, o.d. 3/16", i.d. 2.9 mm	300	0.6	2.0
<b>InB</b>	From Inlet valve B or Inlet valve AB to System pump B	FEP, o.d. 1/8", i.d. 1.6 mm	FEP, o.d. 3/16", i.d. 2.9 mm	300	0.6	2.0

Label	Description	Tubing		Length (mm)	Volume (ml)	
		ÄKTA pure 25	ÄKTA pure 150		ÄKTA pure 25	ÄKTA pure 150
<b>S1-S7</b>	Inlets to Sample inlet valve V9-IS or V9H-IS	FEP, o.d. 1/8", i.d. 1.6 mm	FEP, o.d. 3/16", i.d. 2.9 mm	1000	2.0	6.6
<b>Buff</b>	Inlet to Sample inlet valve V9-IS or V9H-IS	FEP, o.d. 1/8", i.d. 1.6 mm	FEP, o.d. 3/16", i.d. 2.9 mm	1000	2.0	6.6
<b>InS</b>	From Sample inlet valve V9-IS or V9H-IS to Sample pump S9 or S9H, respectively	FEP, o.d. 1/8", i.d. 1.6 mm	FEP, o.d. 3/16", i.d. 2.9 mm	580	1.2	3.8

**Note:** Narrow inlet tubing, ETFE, o.d. 1/16", i.d. 0.75 mm, is available for **S1-S7**.

## High pressure tubing

The tables below shows the labels, standard diameters, and standard lengths of the standard high pressure tubing and the optional high pressure tubing.

### Standard high pressure tubing

Label	Description	Tubing		Length (mm)	Volume (µl)	
		ÄKTA pure 25	ÄKTA pure 150		ÄKTA pure 25	ÄKTA pure 150
<b>1A1</b>	System pump A left to Restrictor A	PEEK, o.d. 1/16", i.d. 0.75 mm	PEEK, o.d. 1/16", i.d. 1.0 mm	340	150	270
<b>1A2</b>	System pump A right to Restrictor A	PEEK, o.d. 1/16", i.d. 0.75 mm	PEEK, o.d. 1/16", i.d. 1.0 mm	340	150	270
<b>2A</b>	Restrictor A to Pressure monitor	PEEK, o.d. 1/16", i.d. 0.75 mm	PEEK, o.d. 1/16", i.d. 1.0 mm	115	50	90
<b>1B1</b>	System pump B left to Restrictor B	PEEK, o.d. 1/16", i.d. 0.75 mm	PEEK, o.d. 1/16", i.d. 1.0 mm	340	150	270
<b>1B2</b>	System pump B right to Restrictor B	PEEK, o.d. 1/16", i.d. 0.75 mm	PEEK, o.d. 1/16", i.d. 1.0 mm	340	150	270

Label	Description	Tubing		Length (mm)	Volume (µl)	
		ÄKTA pure 25	ÄKTA pure 150		ÄKTA pure 25	ÄKTA pure 150
<b>2B</b>	Restrictor B to Pressure monitor	PEEK, o.d. 1/16", i.d. 0.75 mm	PEEK, o.d. 1/16", i.d. 1.0 mm	115	50	90
<b>1S1</b>	Sample pump left to Restrictor S	PEEK, o.d. 1/16", i.d. 0.75 mm	PEEK, o.d. 1/16", i.d. 1.0 mm	340	150	270
<b>1S2</b>	Sample pump right to Restrictor S	PEEK, o.d. 1/16", i.d. 0.75 mm	PEEK, o.d. 1/16", i.d. 1.0 mm	340	150	270
<b>2S</b>	Restrictor S to Sample pressure monitor	PEEK, o.d. 1/16", i.d. 0.75 mm	PEEK, o.d. 1/16", i.d. 1.0 mm	115	50	90
<b>3S</b>	Sample pressure monitor to injection valve.	PEEK, o.d. 1/16", i.d. 0.75 mm	PEEK, o.d. 1/16", i.d. 1.0 mm	530	230	420
<b>3</b>	Pressure monitor to Mixer	PEEK, o.d. 1/16", i.d. 0.75 mm	PEEK, o.d. 1/16", i.d. 1.0 mm	400	180	310
<b>4</b>	Mixer to Injection valve	PEEK, o.d. 1/16", i.d. 0.75 mm	PEEK, o.d. 1/16", i.d. 1.0 mm	200	90	160
<b>5</b>	Injection valve to Column valve	PEEK, o.d. 1/16", i.d. 0.50 mm	PEEK, o.d. 1/16", i.d. 0.75 mm	160	30	70
<b>6</b>	Column valve to UV monitor	PEEK, o.d. 1/16", i.d. 0.50 mm	PEEK, o.d. 1/16", i.d. 0.75 mm	160	30	70
<b>7</b>	UV monitor to Conductivity monitor	PEEK, o.d. 1/16", i.d. 0.50 mm	PEEK, o.d. 1/16", i.d. 0.75 mm	170	30	80
<b>8</b>	Conductivity monitor to Flow restrictor	PEEK, o.d. 1/16", i.d. 0.50 mm	PEEK, o.d. 1/16", i.d. 0.75 mm	95	20	40
<b>9</b>	Flow restrictor to Outlet valve	PEEK, o.d. 1/16", i.d. 0.50 mm	PEEK, o.d. 1/16", i.d. 0.75 mm	135	30	60



Label	Description	Tubing		Length (mm)	Volume (µl)	
		ÄKTA pure 25	ÄKTA pure 150		ÄKTA pure 25	ÄKTA pure 150
<b>Frac</b>	Outlet valve to Fraction collector F9-R	PEEK, o.d. 1/16", i.d. 0.50 mm	PEEK, o.d. 1/16", i.d. 0.75 mm	400	180	310
	Outlet valve to Fraction collector F9-C	PEEK, o.d. 1/16", i.d. 0.50 mm	PEEK, o.d. 1/16", i.d. 0.75 mm	350	70	160

**Note:** Tubing of different inner diameter can be used for tubing **Frac** and tubing **5** to **9**. An inner diameter (i.d.) of 0.5 mm is standard, but tubing kits of 0.25 mm i.d., 0.75 mm i.d. and 1.0 mm i.d. are also available. Tubing **3S** is not included in the kits, but should be changed to 1.0 mm i.d. if the Tubing kit 1.0 is used.

### Optional high pressure tubing

Label	Description	Tubing		Length (mm)	Volume (µl)	
		ÄKTA pure 25	ÄKTA pure 150		ÄKTA pure 25	ÄKTA pure 150
<b>3-1</b>	Pressure monitor to Mixer valve	PEEK, o.d. 1/16", i.d. 0.75 mm	PEEK, o.d. 1/16", i.d. 1.0 mm	160	70	130
<b>3-2</b>	Mixer valve to Mixer	PEEK, o.d. 1/16", i.d. 0.75 mm	PEEK, o.d. 1/16", i.d. 1.0 mm	330	150	260
<b>3-3</b>	Mixer valve to Injection valve	PEEK, o.d. 1/16", i.d. 0.75 mm	PEEK, o.d. 1/16", i.d. 1.0 mm	260	120	200
<b>8pH</b>	Conductivity monitor to pH valve	PEEK, o.d. 1/16", i.d. 0.50 mm	PEEK, o.d. 1/16", i.d. 0.75 mm	180	40	80
<b>9pH</b>	pH valve to Outlet valve	PEEK, o.d. 1/16", i.d. 0.50 mm	PEEK, o.d. 1/16", i.d. 0.75 mm	160	30	70
<b>L1</b>	Injection valve port <b>LoopF</b> to Loop valve port <b>F</b>	PEEK, o.d. 1/16", i.d. 0.50 mm	PEEK, o.d. 1/16", i.d. 0.75 mm	160	30	70
<b>L2</b>	Injection valve port <b>LoopE</b> to Loop valve port <b>E</b>	PEEK, o.d. 1/16", i.d. 0.50 mm	PEEK, o.d. 1/16", i.d. 0.75 mm	160	30	70

Label	Description	Tubing		Length (mm)	Volume (µl)	
		ÄKTA pure 25	ÄKTA pure 150		ÄKTA pure 25	ÄKTA pure 150
<b>1R</b>	From pH flow cell to flow restrictor	PEEK, o.d. 1/16", i.d. 0.50 mm	PEEK, o.d. 1/16", i.d. 0.75 mm	80	20	40
<b>2R</b>	From flow restrictor to pH flow cell	PEEK, o.d. 1/16", i.d. 0.50 mm	PEEK, o.d. 1/16", i.d. 0.75 mm	80	20	40

**Note:** Tubing of different inner diameter can be used for tubing **8pH, 9pH, 1R** and **2R**. An inner diameter (i.d.) of 0.5 mm is standard, but tubing kits of 0.25 mm i.d., 0.75 mm i.d. and 1.0 mm i.d. are also available.

## Reference capillary

The table below shows the label, diameter, and standard length of the reference capillary. The capillary is used during the System performance tests.

Label	Description	Tubing	Length (mm)	Volume (µl)
<b>Ref 1</b>	Reference capillary	PEEK, o.d. 1/16", i.d. 0.25 mm	400	20

## Outlet tubing

The table below shows the labels, diameters, and standard lengths of the outlet tubing. The tubing is not mounted on delivery.

Label	Description	Tubing	Length (mm)	Volume (ml)
<b>Out</b>	Outlets from Outlet valve <b>V9-Os</b> or <b>V9H-Os</b>	ETFE, o.d. 1/16", i.d. 1.0 mm	1500	1.2
<b>Out1 - Out10</b>	Outlets from Outlet valve <b>V9-O</b> or <b>V9H-O</b>	V9-O: ETFE, o.d. 1/16", i.d. 1.0 mm V9H-O: FEP o.d.1/8", i.d. 1.6 mm	1500	1.2 3.0

## Waste tubing

The table below shows the labels, diameters, and standard lengths of the waste tubing. The waste tubing is mounted on delivery.

Label	Description	Tubing	Length (mm)	Volume (ml)
<b>W1</b>	System pump waste	ETFE, o.d. 1/16", i.d. 1.0 mm	1500	1.2

Label	Description	Tubing	Length (mm)	Volume (ml)
<b>W2</b>	Sample pump waste	ETFE, o.d. 1/16", i.d. 1.0 mm	1500	1.2
<b>W3</b>	pH valve waste	ETFE, o.d. 1/16", i.d. 1.0 mm	1500	1.2
<b>W</b>	System waste	ETFE, o.d. 1/16", i.d. 1.0 mm	1500	1.2
N/A	Top tray waste	Silicone, o.d. 12 mm, i.d. 8 mm	1500	80
N/A	Fraction collector F9-C waste	Silicone, o.d. 12 mm, i.d. 8 mm	1350	70

## 9.4 Recommended tubing kits for prepacked columns

This section specifies recommended tubing kits for prepacked columns used with ÄKTA pure.

**Note:** Where alternative tubing kits are listed for a given column, the **Pressure control** option may be used instead of changing the tubing kit to adapt to different run conditions. Refer to [Section 9.15 Pressure control, on page 500](#) for details.

Column name	Recommended Tubing Kits		Comments
	Standard system <sup>1</sup>	Advanced system <sup>2</sup>	
All HiTrap 1 ml (including HisTrap™, GSTrap™, StrepTrap™)	0.5	0.5 with <b>Pressure control</b> or 0.75	
All HiTrap 5 ml (including HisTrap, GSTrap except 4B, StrepTrap)	0.5 or 0.75	0.75	0.75 with <b>Pressure control</b> for maximum flow rate combined with high viscosity.
GSTrap 4B, 5 ml	0.5 or 0.75	0.5 with <b>Pressure control</b> or 0.75	
All HiScreen	0.5 or 0.75	0.5 with <b>Pressure control</b> or 0.75	
RESOURCE™ Q, S, ETH, ISO, PHE and RPC 1 ml	0.5	0.5	
RESOURCE RPC 3 ml	0.5	0.5	
RESOURCE Q, S 6 ml	0.5 or 0.75	0.75	0.75 with <b>Pressure control</b> for maximum flow rate combined with high viscosity.
SOURCE™ 15RPC ST 4.6/100	0.5	0.5	Avoid combination of column valve <b>V9-C</b> and pH position in valve <b>V9-pH</b> . Resolution may be improved with 0.25.
SOURCE 15Q, S, PHE 4.6/100 PE	0.5	0.5	Avoid combination of column valve <b>V9-C</b> and pH position in valve <b>V9-pH</b> . Resolution may be improved with 0.25.
Mini Q™, Mini S™ 4.6/50 PE	0.25 or 0.5	0.25 or 0.5	Use 0.25 for maximum resolution. Avoid column valve <b>V9-C</b> and pH position in <b>V9-pH</b> .

Column name	Recommended Tubing Kits		Comments
	Standard system <sup>1</sup>	Advanced system <sup>2</sup>	
Mono Q™, Mono S™, Mono P™ HR 5/5	0.5	0.5	Avoid combination of column valve <b>V9-C</b> or <b>V9H-C</b> and pH position in valve <b>V9-pH</b> or <b>V9H-pH</b> . Resolution may be improved with 0.25.
Mono P HR 5/20	0.5	0.5	
Mono Q, S HR 10/10	0.5	0.5	
Mono Q, Mono S HR 16/10	0.5 or 0.75	0.5 or 0.75	
Superdex™ Peptide, 75, 200 Superose™ 6, 12 HR 10/30	0.5	0.5	
Mono Q, Mono S 4.6/100 PE	0.5	0.5	Avoid combination of column valve <b>V9-C</b> or <b>V9H-C</b> and pH position in valve <b>V9-pH</b> or <b>V9H-pH</b> . Resolution may be improved with 0.25.
Mono Q, Mono S, Mono P 5/50 GL	0.5	0.5	Avoid combination of column valve <b>V9-C</b> or <b>V9H-C</b> and pH position in valve <b>V9-pH</b> or <b>V9H-pH</b> . Resolution may be improved with 0.25.
Superdex 200 5/150 GL	0.25	0.25	Avoid column valve <b>V9-C</b> and pH position in <b>V9-pH</b> .
Mono P 5/200 GL	0.5	0.5	
Mono Q, Mono S 10/100 GL	0.5 or 0.75	0.5 or 0.75	
Superdex Peptide, 75, 200, Superose 6, 12 10/300 GL	0.5	0.5	
All HiPrep™ 16/10 (including GSTPrep FF, HisPrep FF)	0.5 or 0.75	0.75	
HiPrep 16/60 Sephacryl™ S 100-500 HR	0.5 or 0.75	0.5 with <b>Pressure control</b> or 0.75	
HiPrep 26/10 Desalting HiPrep 26/10 Sepharose™ 6 FF	0.5 with Pressure Control or 0.75	0.75 with <b>Pressure control</b> or 1.0	

## 9 Reference information

### 9.4 Recommended tubing kits for prepacked columns

Column name	Recommended Tubing Kits		Comments
	Standard system <sup>1</sup>	Advanced system <sup>2</sup>	
HiPrep 26/60 Sephacryl S 100-500 HR	0.5 or 0.75	0.5 with <b>Pressure control</b> or 0.75	
HiLoad™ 16/10 Phenyl Sepharose HP, Q Sepharose HP, SP Sepharose HP	0.5 or 0.75	0.5 with <b>Pressure control</b> or 0.75	
HiLoad 16/60 Superdex 30 pg, 75 pg, 200 pg	0.5 or 0.75	0.5 with <b>Pressure control</b> or 0.75	
HiLoad 26/10 Phenyl Sepharose HP, Q Sepharose HP, SP Sepharose HP	0.5 or 0.75	0.75	
HiLoad 26/60 Superdex 30 pg, 75 pg, 200 pg	0.5 or 0.75	0.5 with <b>Pressure control</b> or 0.75	

<sup>1</sup> Standard system configuration.

Normal flow rates.

Moderate sample and buffer viscosities.

<sup>2</sup> Complex system configuration (for additional tubing, use the same tubing dimension as the Tubing Kit).

Maximum flow rates.

High viscosities ( $\geq 3$  cP).

## 9.5 Chemical resistance guide

### Introduction

This section provides general information about biocompatibility and detailed information about chemical resistance of the ÄKTA pure instrument.

---

### In this section

Section	See page
9.5.1 General information about biocompatibility and chemical resistance	432
9.5.2 Chemical resistance specifications	433

---

## 9.5.1 General information about biocompatibility and chemical resistance

### Biocompatibility

The ÄKTA pure instrument is designed for maximum biocompatibility, with biochemically inert flow paths constructed mainly from titanium, PEEK and highly resistant fluoropolymers and fluoroelastomers. Titanium is used as far as possible to minimize contribution of potentially deactivating metal ions such as iron, nickel and chromium. There is no standard stainless steel in the flow path. Plastics and rubber materials are selected to avoid leakage of monomers, plasticizers or other additives.

---

### Cleaning chemicals

Strong cleaning works well with 2 M sodium hydroxide, 70% acetic acid or the alcohols methanol, ethanol and isopropyl alcohol. Complete system cleaning using 1 M hydrochloric acid should be avoided in order to not damage the pressure sensors. If you are cleaning separation media using 1 M hydrochloric acid, use loop injections of the acid and make sure that the column is not mounted on the Column Valve **V9-C**. The Column Valve **V9-C** contains a pressure sensor which can be damaged by 1 M hydrochloric acid.

If sodium hypochlorite is used as sanitizing agent instead of 2 M sodium hydroxide, use a concentration up to 10%.

---

### Organic solvents

Reversed phase chromatography of proteins works well with 100% acetonitrile and additives trifluoroacetic acid (TFA) up to 0.2% or formic acid up to 5%.

Strong organic solvents like ethyl acetate, 100% acetone or chlorinated organic solvents should be avoided. These might cause swelling of plastic material and reduce the pressure tolerance of PEEK tubing. For this reason, flash chromatography and straight ("normal") phase chromatography is generally not recommended on the system

---

### Assumptions made

The ratings are based on the following assumptions:

- Synergy effects of chemical mixtures have not been taken into account.
- Room temperature and limited overpressure is assumed.

**Note:** *Chemical influences are time and pressure dependent. Unless otherwise stated, all concentrations are 100%.*

---



## 9.5.2 Chemical resistance specifications

### Introduction

This section provides detailed information about chemical resistance of the ÄKTA pure instrument to some of the most commonly used chemicals in liquid chromatography. Regarding exposure to solutions not covered by this information, contact your GE representative for recommendations.

**Note:** *A user can be exposed to large volumes of chemical substances over a long time period. Material Safety Data Sheets (MSDS) provide the user with information regarding characteristics, human and environmental risks and preventive measures. Make sure that you have the MSDS available from your chemical distributor and/or databases on the internet.*

### Aqueous buffers

The specified aqueous buffers are suitable for continuous use.

Chemical	Concentration	CAS no/EC no
Aqueous buffers pH 2-12	N/A	N/A

### Strong chemicals and salts for CIP

The following chemicals are suitable for up to 2 h contact time at room temperature.

Chemical	Concentration	CAS no/EC no
Acetic acid	70%	75-05-8/ 200-835-2
Decon 90	10%	N/A
Ethanol	100%	75-08-1/ 200-837-3
Methanol	100%	67-56-1/ 200-659-6
Hydrochloric acid <sup>1</sup>	0.1 M	7647-01-0/ 231-595-7
Isopropanol	100%	67-63-0/ 200-661-7
Sodium hydroxide	2 M	1310-73-2/ 215-185-5
Sodium hydroxide/ethanol	1 M/40%	N/A
Sodium chloride	4 M	7647-14-5/ 231-598-3
Sodium hypochlorite	10%	7681-52-9/231-668-3

<sup>1</sup> If hydrochloric acid, HCl, is used as a cleaning agent when columns are connected to the system, the HCl concentration should not exceed 0.1 M in the pressure sensors. Remember that the ÄKTA pure system has pressure sensors in the column valve **V9-C**.

For other parts of the system up to 1 M HCl is acceptable for short periods of use. See [Cleaning chemicals, on page 432](#)

## Solubilization and denaturing agents

The following chemicals are suitable for continuous use, as additives in separation and purification methods.

Chemical	Concentration	CAS no/EC no
Guanidinium hydrochloride	6 M	50-01-1/ 200-002-3
Sodium dodecyl sulfate (SDS)	1%	151-21-3/ 205-788-1
Tween™ 20	1%	9005-64-5/ 500-018-3
Urea	8 M	57-13-6/ 200-315-5

## Chemicals used in reversed phase chromatography (RPC)

The following chemicals are suitable for continuous use.

Chemical	Concentration	CAS no/EC no
Acetonitrile <sup>1</sup>	100%	75-05-8/ 200-835-2
Acetonitrile/Tetrahydrofuran <sup>1</sup>	85%/15%	109-99-9/ 203-726-8
Acetonitrile/water/Trifluoroacetic acid (TFA) <sup>2</sup>	Max 0.2% TFA	N/A
Ethanol	100%	75-08-1/ 200-837-3
Isopropanol	100%	67-63-0/ 200-661-7
Methanol	100%	74-93-1/ 200-659-6
Water/organic mobile phase/formic acid	Max 5% formic acid	N/A

<sup>1</sup> Organic solvents can penetrate weaknesses in PEEK tubing walls more easily than water based buffers. Special care should therefore be taken with prolonged use of organic solvents close to pressure limits. Depending on pressure, tubing between pump head and pressure monitor needs to be changed. See [Section 7.8.1 Replace tubing and connectors, on page 317](#) for more information.

<sup>2</sup> Mobile phase system.

**Note:** *It is recommended to replace the mixer sealing ring with the highly resistant O-ring (product code 29-0113-26) if the system is to be exposed to organic solvents or high concentrations of organic acids, such as acetic acid and formic acid, for a longer period of time.*

## Salts and additives for hydrophobic interaction chromatography (HIC)

The following chemicals are suitable for continuous use.

Chemical	Concentration	CAS no/EC no
Ammonium chloride	2 M	12125-02-9/ 235-186-4
Ammonium sulfate	3 M	7783-20-2/ 231-984-1
Ethylene glycol	50%	107-21-1/ 203-473-3
Glycerol	50%	56-81-5/ 200-289-5

## Reducing agents and other additives

The following chemicals are suitable for continuous use.

Chemical	Concentration	CAS no/EC no
Arginine	2 M	74-79-3/ 200-811-1
Benzyl alcohol	2%	100-51-6/ 202-859-9
Dithioerythritol (DTE)	100 mM	3483-12-3 / 222-468-7
Dithiothreitol (DTT)	100 mM	3483-12-3 / 222-468-7
Ethylenediaminetetraacetic acid (EDTA)	100 mM	60-00-4/ 200-449-4
Mercaptoethanol	20 mM	37482-11-4/ 253-523-3
Potassium chloride	4 M	7447-40-7/ 231-211-8

## Other substances

The following chemicals are suitable for continuous use.

Chemical	Concentration	CAS no/EC no
Acetone	10%	67-64-1/ 200-662-2
Ammonia	30%	7664-41-7/ 231-635-3
Dimethyl sulphoxide (DMSO)	5%	67-68-5/ 200-664-3
Ethanol for long-term storage	20%	75-08-1/ 200-837-3
Phosphoric acid	0.1 M	7664-38-2/ 231-633-2

## 9.6 Wetted materials

### Material definitions

The tables below list the materials that come into contact with process fluids in the ÄKTA pure system.

#### Primary flow path: Material

Material	Abbreviation
Ethylene ChloroTriFluoroEthylene	ECTFE
Ethylene TetraFluoroEthylene	ETFE
Fluorinated Ethylene Propylene	FEP
Fluorinated Propylene Monomer	FPM/FKM
Fully Fluorinated Propylene Monomer	FFPM/FFKM
PolyChloroTriFluoroEthylene	PCTFE
PolyEtherEtherKetone	PEEK
PolyPropylene	PP
PolyTetraFluoroEthylene	PTFE
PolyVinylidene DiFluoride	PVDF
UltraHighMolecularWeightPolyEthylene	UHMWPE
Aluminum oxide	
Elgiloy™	
Hastelloy™ C-276	
Quartz glass	
Ruby	
Sapphire	
Titanium grade 2	
Titanium grade 5	

## Pump rinse system: Material

Material	Abbreviation
EthylenePropyleneDiene M-class rubber	EPDM
PolyEtherEtherKetone	PEEK
PolyPropylene	PP
PolyPhenylene Sulfide	PPS
PolyVinylidene DiFluoride	PVDF
Silicone	

## 9.7 Predefined methods and phases

### Introduction

A predefined method contains a set of phases, each phase reflecting a specific stage of a chromatography or maintenance run. You can select additional phases from the phase libraries and add these to an existing method, or remove phases that are not required.

The predefined purification methods have default values with suitable running conditions for the chosen column type such as flow and pressure limits. Other settings (e.g., sample application technique, sample volume, elution profile and fractionation) are set on the **Phase Properties** pane in the appropriate phases.

This section describes the predefined methods and phases.

A method is built up by a number of phases. Each phase represents a major process step in the method, for example, equilibration or elution. Predefined methods, that include all the phases necessary to run the system, are available for different chromatography techniques and also for system cleaning.

This sections contains the following subsections:

Section	See page
9.7.1 Predefined purification methods	439
9.7.2 Predefined maintenance methods	445
9.7.3 Predefined phases	446

## 9.7.1 Predefined purification methods



The **Method Editor** has predefined methods for different separation techniques. The methods include a number of relevant phases.























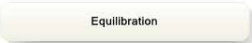

The table below describes the available predefined purification methods and which phases that are included.

Predefined purification method	Principle	Included phases
<b><i>Affinity Chromatography (AC)</i></b>	After equilibration and sample application, the protein of interest is adsorbed to the column ligand. After a wash to remove unbound sample, elution is performed either by using a buffer containing a competitor to displace the protein of interest, or by changing the pH or ionic strength. Finally, the column is re-equilibrated with start buffer.	

Predefined purification method	Principle	Included phases
<p><b>Affinity Chromatography (AC) with Tag Removal</b></p>	<p>After equilibration, the sample of tagged protein is applied. After washing to remove unbound sample the column is equilibrated with cleavage buffer, a protease is applied and the flow is stopped. The cleaved protein and the protease are eluted by starting the flow. The next step regenerates the column, eluting the tag, un-cleaved protein and protease (if tagged). Finally, the column is re-equilibrated.</p> <p><b>Required components</b></p> <p>The required components for this method are Inlet valve (2-ports or 7-ports) and Mixer valve, or the sample pump.</p> <p><b>Required solutions</b></p> <p>The method phases are pre-configured to use the following solutions in the following inlets and loop:</p> <p>Inlet A1: Equilibration buffer          Inlet A2 or sample inlet: Sample          Inlet B1: Cleavage buffer          Inlet B2: Affinity Regeneration buffer          Loop: Protease</p> <p><b>Note:</b></p> <ul style="list-style-type: none"> <li>• Select <b>Inject sample directly onto the column</b> in the sample application phase.</li> <li>• The protease application phase is preconfigured to empty the loop with the protease with a volume of 0.7 ml. The recommended protease volume is 0.7 CV (column volume). If a column volume different than 1 ml is used, this value needs to be changed to correspond to 0.7 CV.</li> </ul>	



Predefined purification method	Principle	Included phases
<p><b>Anion Exchange Chromatography (AIEX)</b></p>	<p>After equilibration and sample application, negatively charged proteins are adsorbed to the column ligand. After a wash, to remove unbound sample, elution is performed using a gradient of increasing salt concentration (of e.g. NaCl). Finally, the column is washed and re-equilibrated with start buffer.</p>	 <pre> graph TD     A[Method Settings] --&gt; B[Equilibration]     B --&gt; C[Sample Application]     C --&gt; D[Column Wash]     D --&gt; E[Elution]     E --&gt; F[Column Wash]     F --&gt; G[Equilibration]           </pre>
<p><b>Cation Exchange Chromatography (CIEC)</b></p>	<p>After equilibration and sample application, positively charged proteins are adsorbed to the column ligand. After a wash, to remove unbound sample, elution is performed using a gradient of increasing salt concentration (of e.g. NaCl). Finally, the column is washed and re-equilibrated with start buffer.</p>	 <pre> graph TD     A[Method Settings] --&gt; B[Equilibration]     B --&gt; C[Sample Application]     C --&gt; D[Column Wash]     D --&gt; E[Elution]     E --&gt; F[Column Wash]     F --&gt; G[Equilibration]           </pre>
<p><b>Chromatofocusing (CF)</b></p>	<p>After equilibration and sample application, elution is performed using a pH gradient. The proteins separate and elute according to their isoelectric points. Finally, the column is re-equilibrated.</p>	 <pre> graph TD     A[Method Settings] --&gt; B[Equilibration]     B --&gt; C[Sample Application]     C --&gt; D[Elution]     D --&gt; E[Equilibration]           </pre>

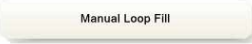

















Predefined purification method	Principle	Included phases
<b>Desalting</b>	After equilibration and sample application, the proteins are eluted isocratically. This technique is commonly used for buffer exchange.	     
<b>Gel filtration (GF)</b>	After equilibration and sample application, proteins separate and elute according to their size (largest first).	     
<b>Hydrophobic Interaction Chromatography (HIC)</b>	After equilibration and sample application (use a buffer containing a high salt concentration, for example 2 M ammonium sulfate) hydrophobic proteins are adsorbed to the column ligand. After a wash to remove unbound sample, elution is performed using a gradient of decreasing salt concentration. Finally, the column is washed and re-equilibrated with start buffer.	           
<b>Manual Loop Fill</b>	<p>The sample application loops of the loop valve are manually filled with samples. The method will guide the user through the process by pausing and displaying on-screen instructions. Up to five loops can be filled with different samples. The loops are filled in descending order. Partial or complete loop fill can be chosen. Automatic washing of loops and flow path are integrated in the method.</p> <p>The required components for this phase are a column valve and a loop valve.</p>	 

Predefined purification method	Principle	Included phases
<p><b>NHS-coupling</b></p>	<p>A column packed with NHS-activated Sepharose is washed with 1 mM HCl, followed by immediate application of the protein for covalent coupling onto the column. After incubation the non-bound protein is washed out and the remaining active groups are deactivated with ethanolamine buffer, followed by further washes.</p> <p><b>Required components</b></p> <p>The required component for this method is an Inlet valve (2-ports or 7-ports).</p> <p><b>Required solutions</b></p> <p>The method phases are preconfigured to use the following solutions in the following inlets and sample loop:</p> <p>Inlet A1: Coupling buffer, for example 0.2 M NaHCO<sub>3</sub> + 0.5 M NaCl pH 8.3.</p> <p>Inlet A2: Activation solution, for example 1 mM HCl</p> <p>Inlet B1: High pH buffer, for example 0.5 M ethanolamine, 0.5 M NaCl pH 8.3</p> <p>Inlet B2: Low pH buffer, for example 0.1 M Sodium acetate, 0.5 M NaCl pH 4.0</p> <p>Sample loop: Ligand in coupling buffer</p> <p><b>Note:</b></p> <p><i>The NHS coupling phase is preconfigured to empty the loop with the ligand with a volume of 1 ml. The recommended ligand volume is 1 CV (column volume). If a column volume different than 1 ml is used, this value needs to be changed to correspond to 1 CV.</i></p>	

Predefined purification method	Principle	Included phases
<p><b><i>Reversed Phase Chromatography (RPC)</i></b></p>	<p>After equilibration and sample application, hydrophobic proteins adsorb to the column ligand. After a wash to remove unbound sample, elution is performed by generating a gradient of a non-polar, organic solvent such as acetonitrile. Finally, the column is washed and re-equilibrated.</p>	 <pre> graph TD     A[Method Settings] --&gt; B[Equilibration]     B --&gt; C[Sample Application]     C --&gt; D[Column Wash]     D --&gt; E[Elution]     E --&gt; F[Column Wash]     F --&gt; G[Equilibration]   </pre>

## 9.7.2 Predefined maintenance methods

A number of predefined methods for preparation and cleaning are available. These maintenance methods are used to prepare the system, clean the system, and to fill the system with storage solution. The table below describes the available predefined maintenance methods.

Predefined maintenance method	Principle	Included phases
<b>Column CIP</b>	The column is filled with a cleaning solution. Select inlet positions. Enter the solution identity, volume, flow rate and incubation time. By adding steps, several cleaning solutions can be used. Suggestions for cleaning steps are available for a number of column types.	 
<b>Column Performance Test</b>	After equilibration of the column, sample is injected via a loop and eluted isocratically. A non-adsorbing sample like acetone or salt should be used. After the run, calculate column performance in the <b>Evaluation</b> module. The efficiency of the column is determined in terms of height equivalent to a theoretical plate (HETP), and the peak asymmetry factor ( $A_s$ ). The result is logged in the column logbook.	   
<b>Column Preparation</b>	The column is filled with buffer solution. Select inlet positions. Enter the solution identity, volume, flow rate and incubation time. By adding steps, several preparation solutions can be used.	 
<b>System CIP</b>	The system is filled with cleaning solution. Select for example inlets, outlets and column positions to be cleaned. Three <b>System CIP</b> phases are included in the method to facilitate the use of three different cleaning solution. Additional <b>System CIP</b> phases can be added from the <b>Phase Library</b> if desired.	     
<b>System Preparation</b>	The system is filled with preparation solution. Select for example inlets, outlets and column positions to be prepared. Two <b>System Preparation</b> phases are included in the method. Additional <b>System Preparation</b> phases can be added from the <b>Phase Library</b> if desired.	   

## 9.7.3 Predefined phases

The table below describes the predefined phases.

Phase Name	Description
<b>Method Settings</b>	<p>The first, and mandatory, phase in any method. Defines common parameters used in the subsequent phases.</p> <p>The <b>Method Settings</b> phase defines:</p> <ol style="list-style-type: none"> <li>1 Column type</li> </ol> <p><b>Note:</b>  <i>The <b>Column type</b> list can be filtered in two steps:</i></p> <ul style="list-style-type: none"> <li>• Select the chromatography technique to be used in the list <b>Show by technique</b></li> <li>• Select <b>Show only suggested columns</b> to show the columns that are suggested for the selected chromatography technique.</li> </ul> <ol style="list-style-type: none"> <li>2 Pressure limit</li> <li>3 Flow rate</li> <li>4 Option to control the flow to avoid overpressure</li> </ol> <p><b>Note:</b>  <i>Default values for pressure limits and flow rate are given for the selected column type.</i></p> <ul style="list-style-type: none"> <li>• Column position</li> <li>• Flow restrictor use</li> <li>• Unit selection for Method base and Flow rate</li> <li>• Monitor settings:             <ul style="list-style-type: none"> <li>- pH monitor</li> <li>- Air sensor alarm settings</li> <li>- UV monitor</li> </ul> </li> </ul> <p><b>Note:</b>  <i>The first wavelength of U9-M and the fixed wavelength for U9-L or U9-L 2nd is always turned on. The second and third wavelengths for UV monitor U9-M can be set on or off.</i></p> <ul style="list-style-type: none"> <li>• Settings for Column Logbook</li> <li>• Start Protocol</li> <li>• Result name and location</li> </ul> <p><b>Note:</b>  <i>Some of these options may not be required by certain methods.</i></p>

Phase Name	Description
<b><i>Equilibration</i></b>	Equilibrates the column before purification, or re-equilibrates the column after purification.
<b><i>Sample Application</i></b>	Applies sample to the column. Defines the sample application technique, the sample volume, and the handling of flowthrough.
<b><i>Column Wash</i></b>	Washes out unbound sample after sample application or removes strongly bound proteins after elution.
<b><i>Elution</i></b>	Elutes the sample from the column. Defines parameters for the elution and fractionation settings.
<b><i>Column Preparation</i></b>	Prepares the column before use by removing the storage solution and equilibrating the column. By adding steps, several preparation solutions can be used sequentially.
<b><i>Column CIP</i></b>	Cleans the column after purification runs by rinsing the column with a cleaning solution to remove nonspecifically bound proteins. By adding steps, several cleaning solutions can be used sequentially.
<b><i>System Preparation</i></b>	Prepares the system before a run by removing storage solution and filling the system and inlets with buffer solution. One preparation solution is used per phase.
<b><i>System CIP</i></b>	Cleans the system after purification runs by rinsing the system with a cleaning solution. One cleaning solution is used per phase.
<b><i>Column performance test</i></b>	Tests the efficiency of a packed column in terms of height equivalent to a theoretical plate (HETP), and the peak asymmetry factor ( $A_s$ ).
<b><i>Manual Loop Fill</i></b>	Is used to manually fill the additional sample application loops mounted on the loop valve. The filling options are: <ul style="list-style-type: none"> <li>• Partial loop fill</li> <li>• Complete loop fill</li> </ul>
<b><i>Miscellaneous</i></b>	Can be added to any method at suitable places. The instructions can help the user to better organize the graphical output of the results or introduce a controlled delay in the method run.

## 9.8 System settings

### Introduction

The **System Settings** function is used to set the parameters for the available instructions. The **Edit** dialog in which to edit the system settings are shown below.

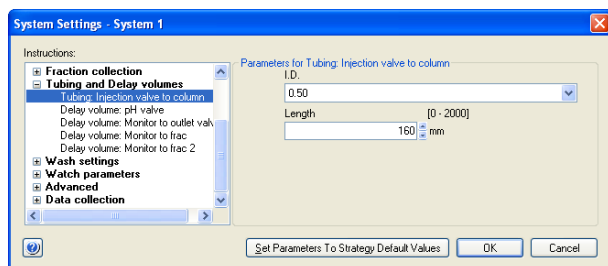

The following subsections list the system settings available for ÄKTA pure.

Section	See page
9.8.1 System settings - UV	449
9.8.2 System settings - Conductivity	450
9.8.3 System settings - pH	451
9.8.4 System settings - Pressure alarms	452
9.8.5 System settings - Air sensor	454
9.8.6 System settings - I/O-box	456
9.8.7 System settings - Fraction collection	457
9.8.8 System settings - Tubing and Delay volumes	459
9.8.9 System settings - Wash settings	461
9.8.10 System settings - Watch parameters	462
9.8.11 System settings - Advanced	463
9.8.12 System settings - Data collection	464



## 9.8.1 System settings - UV

The table below describes the UV related system settings available for ÄKTA pure.

Instruction name	Description
Alarm UV	<b>Alarm UV</b> enables or disables the alarm for the UV signal. When enabled, it sets the alarm limits for the UV signal from UV monitor U9-L. When the UV signal falls outside the set limits, an alarm will be triggered and the method will be paused.
Alarm UV1	<b>Alarm UV 1</b> enables or disables the alarm for the UV 1 signal from UV monitor U9-M. When enabled, it sets the alarm limits for the UV 1 signal. When the signal falls outside the set limits, an alarm is issued and the method will be paused.  <b>Note:</b> <i>It is not possible to set an alarm signal for the UV 2 or UV 3 signals from UV monitor U9-M.</i>
Alarm UV 2nd	<b>Alarm UV 2nd</b> enables or disables the alarm for the UV signal from U9-L, 2nd. When enabled, it sets the alarm limits for the UV signal from UV monitor U9-L, 2nd. When the signal falls outside the set limits, an alarm will be triggered and the method will be paused.
Wavelength	<b>Wavelength</b> sets the wavelengths for UV monitor U9-M. The corresponding curves in the chromatogram are marked with the set wavelengths.  <b>Note:</b> <ul style="list-style-type: none"> <li>• <i>The instruction is available when UV monitor U9-M (variable) is selected in the component list. For best performance, do not use more wavelengths than necessary for the application.</i></li> <li>• <i>At low wavelengths, the eluent can have significant absorbance of its own.</i></li> </ul>
Noise reduction UV	<b>Noise reduction UV</b> filters the noise in the UV signal from U9-M or U9-L (depending on the configuration). A column-specific averaging time is set automatically when a column is defined in a method run and <b>Averaging time</b> is set as a variable.
Noise reduction UV 2nd	<b>Noise reduction UV 2nd</b> filters the noise in the UV signal from U9-L, 2nd. A column-specific averaging time is set automatically when a column is defined in a method run and <b>Averaging time</b> is set as a variable.

## 9.8.2 System settings - Conductivity

The table below describes the conductivity related system settings available for ÄKTA pure.

Instruction name	Description
Alarm conductivity	<p><b>Alarm conductivity</b> enables or disables the conductivity alarm. When enabled, it sets the alarm limits for the conductivity signal. When the conductivity falls outside the set limits, an alarm will be triggered and the method will be paused.</p>
Relative scale cond	<p><b>Relative scale cond</b> facilitates monitoring of a gradient, for which the user sets the conductivity values for 0% and 100%. The <b>Relative scale cond</b> can be set in ascending manner (0% for low and 100% for high conductivity) or in descending manner (0% for high and 100% for low conductivity).</p> <p><b>Note:</b>  <i>The <b>Relative scale cond</b> in descending manner is especially useful for conductivity visualization in RPC and HIC, where the conductivity curve is reversed compared to the concentration curve (i.e., high conductivity at 0% B and low conductivity at 100% B).</i></p>
Cond temp condensation	<p><b>Cond temp compensation</b> is used to adjust the conductivity values to a reference temperature in order to compare conductivity values between runs that have been performed at different temperatures.</p> <p>Setting the compensation factor to 0% turns this function off.</p>

## 9.8.3 System settings - pH

The table below describes the pH related system settings available for ÄKTA pure.

Instruction name	Description
Alarm pH	<b>Alarm pH</b> enables or disables the pH alarm. When enabled, it sets the alarm limits for the pH signal. When the pH falls outside the set limits, an alarm will be triggered and the method will be paused.

## 9.8.4 System settings - Pressure alarms

The table below describes the pressure alarm related system settings available for ÄKTA pure.

Instruction name	Description
Alarm system pressure	<p><b>Alarm system pressure</b> sets the alarm limits for the system pressure. When enabled and the system pressure falls outside the set pressure limits, an alarm will be triggered and the method will be paused. Default values for the alarm limits are set by the values in the column list when a column is selected in the method and <b>Alarm system pressure</b> is set as a variable. <b>Low alarm</b> is only triggered if the pressure first exceeds the <b>Low alarm</b> limit for ten seconds continuously and then falls below the <b>Low alarm</b> limit.</p> <p><b>Note:</b>  <i>Setting the <b>Low alarm</b> or the system flow rate to 0 deactivates the low pressure alarm.</i></p>
Alarm sample pressure	<p><b>Alarm sample pressure</b> sets the alarm limits for the sample pressure. When enabled and the sample pressure falls outside the set pressure limits, an alarm will be triggered and the method will be paused. Default values for the alarm limits are set by the values in the column list when a column is selected in the method and <b>Alarm sample pressure</b> is set as a variable. <b>Low alarm</b> is only triggered if the pressure first exceeds the <b>Low alarm</b> limit for ten seconds continuously and then falls below the <b>Low alarm</b> limit.</p> <p><b>Note:</b>  <i>Setting the <b>Low alarm</b> or the system flow rate to 0 deactivates the low pressure alarm.</i></p>
Alarm delta column pressure	<p><b>Alarm delta column pressure</b> sets the alarm limits for the delta column pressure (pre-column pressure minus post-column pressure). When enabled and the delta column pressure falls outside the set pressure limits, an alarm will be triggered and the method will be paused. <b>Low alarm</b> is only triggered if the pressure first exceeds the <b>Low alarm</b> limit for ten seconds continuously then falls below the <b>Low alarm</b> limit.</p> <p><b>Note:</b></p> <ul style="list-style-type: none"> <li>• <i>Setting the <b>Low alarm</b> to 0 deactivates the low pressure alarm.</i></li> <li>• <i>Instruction <b>Alarm delta column pressure</b> is available only when Column valve <b>V9-C</b> or <b>V9H-C</b> (5-columns) is selected in the component list.</i></li> </ul>

Instruction name	Description
Alarm pre column pressure	<p><b>Alarm pre column pressure</b> sets the alarm limits for the pre column pressure. When enabled and the pre column pressure falls outside the set pressure limits, an alarm is issued and the method will be paused. Default values for the alarm limits are set by the values in the column list when a column is selected in the method and <b>Alarm pre column pressure</b> is set as a variable. <b>Low alarm</b> is only triggered if the pressure first exceeds the <b>Low alarm</b> limit for ten seconds continuously then falls below the <b>Low alarm</b> limit.</p> <p><b>Note:</b> <i>Setting the <b>Low alarm</b> to 0 deactivates the low pressure alarm.</i></p>

## 9.8.5 System settings - Air sensor

The table below describes the air sensor related system settings available for ÄKTA pure.

**Normal** (30 µl) is used to detect when a buffer or sample vessel is empty. **High** (10 µl) is used to detect small air bubbles

Instruction name	Description
Alarm inlet A air sensor	<b>Alarm inlet A air sensor</b> enables or disables the air sensor alarm for the built-in air sensor at inlet A. If the alarm is enabled and air is detected, an alarm will be triggered and the method will be paused.
Alarm inlet B air sensor	<b>Alarm inlet B air sensor</b> enables or disables the air sensor alarm for the built-in air sensor at inlet B. If the alarm is enabled and air is detected, an alarm will be triggered and the method will be paused.
Alarm inlet S air sensor	<b>Alarm inlet S air sensor</b> enables or disables the air sensor alarm for the built-in air sensor at the sample inlet. If the alarm is enabled and air is detected, an alarm will be triggered and the method will be paused.
Alarm external air sensor X	<b>Alarm external air sensor X</b> enables or disables the alarm for the optional air sensor number X. If the alarm is enabled and air is detected, an alarm will be triggered and the method will be paused.
Sensitivity inlet A air sensor	<b>Sensitivity inlet A air sensor</b> is used together with the <b>Alarm inlet A air sensor</b> instruction and sets the sensitivity of the built-in air sensors at inlet A.  <b>Normal</b> (30 µl) is used to detect when a buffer or sample vessel is empty. <b>High</b> (10 µl) is used to detect small air bubbles
Sensitivity inlet B air sensor	<b>Sensitivity inlet B air sensor</b> is used together with the <b>Alarm inlet B air sensor</b> instruction and sets the sensitivity of the built-in air sensors at inlet B.  <b>Normal</b> (30 µl) is used to detect when a buffer or sample vessel is empty. <b>High</b> (10 µl) is used to detect small air bubbles
Sensitivity inlet S air sensor	<b>Sensitivity inlet S air sensor</b> is used together with the <b>Alarm inlet S air sensor</b> instruction and sets the sensitivity of the built-in air sensors at the sample inlet.  <b>Normal</b> (30 µl) is used to detect when a buffer or sample vessel is empty. <b>High</b> (10 µl) is used to detect small air bubbles

Instruction name	Description
Sensitivity external air sensor X	<p><b>Sensitivity external air sensor X</b> is used together with the <b>Alarm external air sensor X</b> instruction and sets the sensitivity of the optional air sensor number X. The optional air sensor can be located either before any of the inlets A or B or after the injection valve.</p> <p><b>Normal</b> (30 µl) is used to detect when a buffer or sample vessel is empty. <b>High</b> (10 µl) is used to detect small air bubbles</p> <ul style="list-style-type: none"><li>- When located before an inlet, the default sensitivity is <b>Normal</b>.</li><li>- When located after the injection valve, the default sensitivity is <b>High</b> and the pump currently pumping onto the column is used for calculating the air volume for the external air sensor.</li></ul> <p><b>Note:</b> <i>Using an air sensor after the injection valve is only useful when running at lower pressures. High pressure dissolves any small air bubbles present.</i></p>

## 9.8.6 System settings - I/O-box

The table below describes the I/O-box related system settings available for ÄKTA pure.

Instruction name	Description
Digital out X	<b>Digital out X</b> sets the value of the signal sent out by digital port number X to either 0 or 1. The default value is 1.
Noise reduction analog in X	<b>Noise reduction analog in X</b> filters the noise in the analog signal in port number X.
Alarm analog in X	<b>Alarm analog in X</b> enables or disables the alarm for the analog signal in port number X. When enabled, it sets the alarm limits for the analog signal. If the alarm is enabled and the analog signal falls outside the set limits, an alarm will be triggered and the method will be paused.
Alarm digital in X	<b>Alarm digital in X</b> enables or disables the alarm for the signal in digital port number X. The alarm can be triggered by either of the signal values, 0 or 1. If the alarm is enabled and the condition set in 'Value' occurs, an alarm will be triggered and the method will be paused.
Configure analog out X	<b>Configure analog out X</b> enables the user to send one of the pre-defined signals (UV signal, conductivity, temperature, pH or concentration of eluent B) to the analog out port number X, and also to set the range of that signal.



## 9.8.7 System settings - Fraction collection

The tables below describe the fraction collection related system settings available for ÄKTA pure.

### Fraction collector F9-C

Instruction name	Description
Fractionation settings	<b>Fractionation settings</b> comprises fractionation mode and fractionation order. <b>Fractionation mode</b> ( <i>Automatic</i> , <i>Accumulator</i> or <i>DropSync</i> ). <b>Fractionation order</b> ( <i>Row-by-row</i> , <i>Column-by-column</i> , <i>Serpentine-row</i> , <i>Serpentine-column</i> ). For fractionation mode <i>DropSync</i> , only the <i>Serpentine</i> option is available.
Last tube filled	<b>Last tube filled</b> : Action when last tube is filled (pause, direct the flow to one of outlets or direct the flow to waste).
Cassette configuration	<b>Cassette configuration</b> : <i>Automatic</i> or <i>Manual</i> configuration. If <i>Automatic</i> is selected, a Quick scan or a Full scan will be performed when the door of the fraction collector is closed to determine which type of cassettes and plates are used. If <i>Manual</i> is selected, used plates and tubes in each tray position are entered.
Fraction collector lamp	<b>Fraction collector lamp</b> : Lamps in the fraction collector chamber on or off.
Peak fractionation parameters	The <b>Peak fractionation parameters</b> set the detection parameters for peak collection, that is they decide when a peak starts and ends. This information is used by the instructions <b>Peak fractionation</b> and <b>Peak frac in outlet valve</b> in order to start/end the peak collection.

### Fraction collector F9-R

Instruction name	Description
Fractionation settings	<b>Drop sync</b> synchronises tube change to drop release. The available settings are on or off. It is recommended to use <b>Drop sync</b> for flow rates below 2 ml/min. Higher flow rates can however be used, depending on the properties (for example viscosity) of the liquid.
Fractionation numbering mode	Determines whether the fraction number is reset at the end of a method or not.  <b>Note:</b> <i>The default setting is <b>Reset</b>.</i>

## 9 Reference information

### 9.8 System settings

#### 9.8.7 System settings - Fraction collection

Instruction name	Description
Fractionation settings frac 2	<b>Drop sync</b> on or off. It is recommended to use this setting for flow rates below 2 ml/min. Higher flow rates can be however be used, depending on the properties (e.g. viscosity) of the liquid.
Fractionation numbering mode frac 2	Determines whether fraction number for the second fraction collector is reset at the end of a method or not.  <b>Note:</b> <i>The default setting is <b>Reset</b>.</i>
Peak fractionation parameters	<b>Peak fractionation parameters</b> sets the detection parameters for peak collection, i.e. it determines when a peak starts and ends. This information is used by the instructions <b>Peak fractionation</b> , <b>Peak fractionation frac 2</b> and <b>Peak frac in outlet valve</b> in order to start/end the peak collection.

## 9.8.8 System settings - Tubing and Delay volumes

The table below describes the system settings related to tubing and delay volumes, available for ÄKTA pure.

Instruction name	Description
Tubing: Injection valve to column	<p>The instruction is used in calculations of pre-column pressure when Column valve <b>V9-C</b> or <b>V9H-C</b> (5-columns) is not mounted onto the system. In such cases, there is no pre-column pressure sensor present. The estimated pre-column pressure is either calculated by using the measured system pressure and the length of the tubing between the system pressure sensor and the column valve or by using the measured sample pressure and the length of the tubing between the sample pressure sensor and the column valve depending on the position of the injection valve.</p> <p>The instruction is available only when Column valve <b>V9-C</b> or <b>V9H-C</b> (5-columns) is not selected in the component list.</p>
Tubing: Sample pump to injection valve	<p>The instruction is used in calculations of pre-column pressure when Column valve <b>V9-C</b> or <b>V9H-C</b> (5-columns) is not mounted onto the system. In such cases, there is no pre-column pressure sensor present. The estimated pre-column pressure is either calculated by using the measured system pressure and the length of the tubing between the system pressure sensor and the column valve or by using the measured sample pressure and the length of the tubing between the sample pressure sensor and the column valve depending on the position of the injection valve.</p> <p>The instruction is available only when Column valve <b>V9-C</b> or <b>V9H-C</b> (5-columns) is not selected and a sample pump (<b>S9</b> or <b>S9H</b>) is selected in the component list.</p>
Delay volume: pH valve	<p><b>Delay volume: pH valve</b> is used to calculate the delay volume between the monitor and the Outlet valve. The instruction is used to make sure that the collected fractions correspond to the fractions indicated in the chromatogram. It is recommended not to alter the default values for restrictor and pH cell delay volumes when standard modules and standard tubing for flow restrictor are used.</p>
Delay volume: Monitor to outlet valve	<p><b>Delay volume: Monitor to outlet valve</b> is used to define the delay volume between the monitor and the Outlet valve. The instruction is used to make sure that the collected fractions correspond to the fractions indicated in the chromatogram. The delay volume must be changed when changing tubing to another I.D. or length or when removing or adding components.</p>

## 9 Reference information

### 9.8 System settings

#### 9.8.8 System settings - Tubing and Delay volumes

Instruction name	Description
Delay volume: Monitor to frac	<b>Delay volume: Monitor to frac</b> is used to define the delay volume between the monitor and the Fraction collector. The instruction is used to make sure that the collected fractions correspond to the fractions indicated in the chromatogram. The instruction is available only when the Fraction collector is selected in the component list.
Delay volume: Monitor to frac 2	<b>Delay volume: Monitor to frac 2</b> is used to define the delay volume between the monitor and the second Fraction collector. The instruction is used to make sure that the collected fractions correspond to the fractions indicated in the chromatogram. The instruction is available only when the second Fraction collector is selected in the component list.

## 9.8.9 System settings - Wash settings

The table below describes the wash related system settings available for ÄKTA pure.

Instruction name	Description
System wash settings	<p><b>System wash settings</b> sets the flow rate used for <b>System wash</b>.</p> <p><b>Note:</b></p> <ul style="list-style-type: none"> <li>• The volume for system wash is set in the <b>System wash</b> instruction.</li> <li>• The flow rate should not exceed 10 ml/min if narrow inlet tubing (i.d. 0.75 mm) is used.</li> <li>• Adjust the flow rate during the system wash so that the system pressure does not exceed 2 MPa.</li> </ul>
System pump wash settings	<p><b>System pump wash settings</b> sets the flow rate and the wash volume used during system pump washes.</p> <p><b>Note:</b></p> <p>The flow rate should not exceed 10 ml/min if narrow inlet tubing (i.d. 0.75 mm) is used.</p>
Sample pump wash settings	<p><b>Sample pump wash settings</b> sets the flow rate and the wash volume used during sample pump washes.</p> <p><b>Note:</b></p> <p>The flow rate should not exceed 10 ml/min if narrow inlet tubing (i.d. 0.75 mm) is used.</p>
Fraction collector wash settings	<p><b>Fraction collector wash settings</b> sets the flow rate during <b>Fraction collector wash</b>.</p>
Mixer by-pass wash settings	<p><b>Mixer by-pass wash settings</b> sets the flow rate used during <b>Mixer by-pass wash</b> and defines wash volumes for mixer by-pass wash options.</p> <p><b>Note:</b></p> <p>The flow rate should not exceed 10 ml/min if narrow inlet tubing (i.d. 0.75 mm) is used.</p>
Loop wash settings	<p><b>Loop wash settings</b> sets the flow rate used during <b>Loop wash</b>.</p> <p><b>Note:</b></p> <ul style="list-style-type: none"> <li>• The volume for system wash is set in the <b>Loop wash</b> instruction.</li> <li>• The flow rate should not exceed 10 ml/min if narrow inlet tubing (i.d. 0.75 mm) is used.</li> </ul>

## 9.8.10 System settings - Watch parameters

The table below describes the watch parameter settings available for ÄKTA pure.

Instruction name	Description
Watch UV parameters	<b>Watch UV parameters</b> sets the accepted signal fluctuation and <b>Delta peak</b> limit of the UV signal for some of the tests in the <b>Watch</b> and <b>Hold until</b> instructions.
Watch UV 2nd parameters	<b>Watch UV 2nd parameters</b> sets the accepted signal fluctuation and <b>Delta peak</b> limit of the UV 2nd signal for some of the tests in the <b>Watch</b> and <b>Hold until</b> instructions.
Watch cond parameters	<b>Watch cond parameters</b> sets the accepted fluctuation and <b>Delta peak</b> limit of the conductivity signal for some of the tests in the <b>Watch</b> and <b>Hold until</b> instructions.
Watch pH parameters	<b>Watch pH parameters</b> sets the value for the accepted fluctuation of the pH signal used for the test <b>Stable signal</b> in the instructions <b>Watch</b> and <b>Hold until</b> .
Watch flow parameters	<b>Watch flow parameters</b> sets the value for the accepted fluctuation of the flow rate signal used for the test <b>Stable signal</b> in the instructions <b>Watch</b> and <b>Hold until</b> with signal <b>System flow</b> .
Watch pressure parameters	<b>Watch pressure parameters</b> sets the value for the accepted fluctuation of the pressure signals used for the test <b>Stable signal</b> in the instructions <b>Watch</b> and <b>Hold until</b> .
Watch analog in parameters	<b>Watch analog in parameters</b> sets the accepted signal fluctuation and <b>Delta peak</b> limit of the analog signal for some of the tests in the <b>Watch</b> and <b>Hold until</b> instructions.

## 9.8.11 System settings - Advanced

The table below describes the advanced system settings available for ÄKTA pure.

Instruction name	Description
Power-save	<b>Power-save</b> sets the instrument into power saving mode. When the function is enabled, the instrument enters power-saving mode after having been in state <b>Ready</b> for a certain time period. The instrument turns into state <b>Ready</b> when a method run, a method queue or a manual run ends. The time interval before the instrument enters power-saving mode is defined by the user.
Instrument control panel	<b>Instrument control panel</b> locks/unlocks the control panel located on the front side of the instrument. When unlocked, the buttons on the Instrument control panel are active and can be used to control a few basic functions of the instrument. When the Instrument control panel is locked, no functions are available.
Pressure control parameters	By using <b>Pressure control</b> the method can be run with the set flow rate without the risk of method stop due to pressure alarm. Pressure control is enabled in the instruction <b>System flow</b> or <b>Sample flow</b> . <b>Pressure control parameters</b> provides the P and I factors used in the regulator and can be adjusted for different columns.
Constant pressure flow parameters	<b>Constant pressure flow parameters</b> sets the values for the P and I factors needed to keep a constant pressure by varying the flow rate. The signal used for pressure control is set in the instruction <b>Constant pressure flow</b> .
Max flow during valve turn	<b>Max flow during valve turn</b> sets the maximum flow rate used during the turning of the injection and outlet valve in order to avoid high pressure alarms.
Method progressing flow	<b>Method progressing flow</b> sets which flow (automatic, system flow, sample flow) the progress of the method is calculated after. In automatic mode, the position of the injection valve determines if the system flow or the sample flow is used.
Sample pump setting	<b>Sample pump setting</b> enables sample pump flow while the injection valve is in manual load position.

## 9.8.12 System settings - Data collection

The table below describes the Data collection related system settings available for ÄKTA pure.

Instruction name	Description
Data collection	<p>The <b>Data collection</b> settings determine the maximum number of data points collected for a given curve. Data reduction occurs if the maximum number of data points is exceeded. To avoid data reduction, set the maximum number of data points to be collected to 180000 or insert a <b>New Chromatogram</b> instruction in the method.</p> <p><b>Note:</b> <i>The default setting is 54000 data points, which corresponds to 1.5 h for a signal of 10 Hz.</i></p>



## 9.9 Manual instructions

It is possible to manually interact with an ongoing method using **Manual instructions**.

Step	Action
1	In the <b>System Control</b> module: <ul style="list-style-type: none"><li>• select <b>Manual:Execute Manual Instructions</b> or</li><li>• use the shortcut <b>Ctrl +M</b>.</li></ul> <i>Result:</i> The <b>Manual instructions</b> dialog opens.
2	In the <b>Manual instructions</b> dialog: <ul style="list-style-type: none"><li>• Click the + symbol to show the instructions for the instruction group that you want to modify.</li><li>• Select the instruction that you want to modify.</li><li>• Enter the new values for the instruction.</li></ul>
3	To execute several instructions at the same breakpoint, select and edit an instruction and click <b>Insert</b> . Repeat for several instructions.
4	To update parameter fields during method run, check the <b>Auto update...</b> box.
5	To perform the instructions, click <b>Execute</b> .

All available manual instructions are described in the following subsections.

Section	See page
9.9.1 Manual instructions - Pumps	466
9.9.2 Manual instructions - Flow path	470
9.9.3 Manual instructions - Monitors	472
9.9.4 Manual instructions - Fraction collection	473
9.9.5 Manual instructions - I/O-box	477
9.9.6 Manual instructions - Alarms	478
9.9.7 Manual instructions - Wash settings	481
9.9.8 Manual instructions - Watch parameters	482
9.9.9 Manual instructions - Advanced	483
9.9.10 Manual instructions - Other	486

## 9.9.1 Manual instructions - Pumps

The table below describes the pump related manual instructions available for ÄKTA pure.

Instruction name	Description
System flow	<p><b>System flow</b> defines the system flow rate.</p> <p>Flow rate can be set either as volumetric or as linear flow. A column type must be selected before using linear flow.</p>
Sample flow	<p><b>Sample flow</b> defines the system flow rate. Flow rate can be set either as volumetric or as linear flow. A column type must be selected before using linear flow.</p>
Gradient	<p><b>Gradient</b> sets a gradient (linear or stepwise) using the system pumps A and B.</p> <p><b>Note:</b>  <i>Set gradient length value to 0 to perform a step gradient.</i></p>
Pump A wash	<p><b>Pump A wash</b> is used to change buffers in the inlet tubing, pump and mixer.</p> <p><b>Note:</b></p> <ul style="list-style-type: none"> <li>• <i>Pressing <b>End</b> during <b>Pump wash</b> will terminate both the wash and the run immediately.</i></li> <li>• <i>Pressing <b>Continue</b> during <b>Pump wash</b> will terminate the wash and the run will continue from the point at which the pump wash instruction was executed.</i></li> <li>• <i>An instruction issued when a <b>Pump wash</b> is in progress will not be executed until the wash is completely finished and all valves have turned back to the previous positions.</i></li> <li>• <i><b>Pump wash</b> cannot be executed when the system is in state <b>HOLD</b>.</i></li> </ul>

Instruction name	Description
Pump B wash	<p><b>Pump B wash</b> is used to change buffers in the inlet tubing, pump and mixer.</p> <p><b>Note:</b></p> <ul style="list-style-type: none"> <li>Pressing <b>End</b> during <b>Pump wash</b> will terminate both the wash and the run immediately.</li> <li>Pressing <b>Continue</b> during <b>Pump wash</b> will terminate the wash and the run will continue from the point at which the <b>Pump wash</b> instruction was executed.</li> <li>An instruction issued when a <b>Pump wash</b> is in progress will not be executed until the wash is completely finished and all valves have turned back to the previous positions.</li> <li><b>Pump wash</b> cannot be executed when the system is in state <b>HOLD</b>.</li> </ul>
Sample pump wash	<p><b>Sample pump wash</b> is used to change buffers in the sample inlet tubing and sample pump.</p> <p><b>Note:</b></p> <ul style="list-style-type: none"> <li>Pressing <b>End</b> during <b>Sample pump wash</b> will terminate both the wash and the run immediately.</li> <li>Pressing <b>Continue</b> during <b>Sample pump wash</b> will terminate the wash and the run will continue from the point at which the <b>Sample pump wash</b> instruction was executed.</li> <li>An instruction issued when a <b>Sample pump wash</b> is in progress will not be executed until the wash is completely finished and all valves have turned back to the previous positions.</li> <li><b>Sample pump wash</b> cannot be executed when the system is in state <b>HOLD</b>.</li> <li>The flow rate should not exceed 10 ml/min if narrow inlet tubing (I.D. 0.75 mm) is used.</li> </ul>

Instruction name	Description
Mixer by-pass wash	<p><b>Mixer by-pass wash</b> is used to wash or fill the flow path (mixer valve and tubing) that is used for sample application with system pump. It is possible to choose a more extensive or a less extensive wash option.</p> <p><b>Note:</b></p> <ul style="list-style-type: none"> <li>Pressing <b>End</b> during <b>Mixer by-pass wash</b> will terminate both the wash and the run immediately.</li> <li>Pressing <b>Continue</b> during <b>Mixer by-pass wash</b> will terminate the wash and the run will continue from the point at which the <b>Mixer by-pass wash</b> instruction was executed.</li> <li>An instruction issued during a <b>Mixer by-pass wash</b> will not be executed until the wash is completely finished and the valves have turned back to the previous positions.</li> <li><b>Mixer by-pass wash</b> cannot be executed when the system is in state <b>HOLD</b>.</li> </ul>
Loop wash	<p><b>Loop wash</b> is used to wash the Loop valve. It is possible to wash a single sample application loop, all loops or only the by-pass position. <b>Loop wash</b> instruction is not available, if a Column valve is not mounted on the system.</p> <p><b>Note:</b></p> <ul style="list-style-type: none"> <li>Pressing <b>End</b> during <b>Loop wash</b> will terminate both the wash and the run immediately.</li> <li>Pressing <b>Continue</b> during <b>Loop wash</b> will terminate the wash and the run will continue from the point at which the <b>Loop wash</b> instruction was executed.</li> <li>An instruction issued when a <b>Loop wash</b> is in progress will not be executed until the wash is completely finished and the valves have turned back to the previous positions.</li> <li><b>Loop wash</b> cannot be executed when the system is in state <b>HOLD</b>.</li> </ul>

Instruction name	Description
System wash	<p><b>System wash</b> is used to fill the system with the selected buffer composition. The flow can be directed to the waste position of either the injection valve or the outlet valve. The flow is directed to the end of the flow path if outlet valve is not present.</p> <p><b>Note:</b></p> <ul style="list-style-type: none"> <li>• <i>Pressing <b>End</b> during <b>System wash</b> will terminate both the wash and the run immediately.</i></li> <li>• <i>Pressing <b>Continue</b> during <b>System wash</b> will terminate the wash and the run will continue from the point at which the <b>System wash</b> instruction was executed.</i></li> <li>• <i>If <b>System wash</b> is performed during a <b>Gradient</b> operation, the current component B concentration is maintained during the wash.</i></li> <li>• <i>An instruction issued during a system wash operation cannot be executed until the wash is completely finished and all valves have turned back to the previous positions.</i></li> <li>• <b>System wash cannot be executed when the system is in state HOLD.</b></li> <li>• <i>Adjust the flow rate during the system wash so that the system pressure does not exceed 2 MPa.</i></li> </ul>

## 9.9.2 Manual instructions - Flow path

The table below describes the flow path related manual instructions available for ÄKTA pure.

Instruction name	Description
Inlet A	<p><b>Inlet A</b> turns Inlet valve A to the selected position.</p> <p><b>Note:</b>            Positions <b>A1 - A7</b> are available, if Inlet valve <b>V9-IA</b> or <b>V9H-IA</b> (7-ports) is used. Only positions <b>A1</b> and <b>A2</b> are available, if Inlet valve <b>V9-IAB</b> or <b>V9H-IAB</b> (2-ports) is used.</p>
Inlet B	<p><b>Inlet B</b> turns the Inlet valve B to the selected position.</p> <p><b>Note:</b>            Positions <b>B1 - B7</b> are available, if Inlet valve <b>V9-IB</b> or <b>V9H-IB</b> (7-ports) is used. Only positions <b>B1</b> and <b>B2</b> are available, if Inlet valve <b>V9-IAB</b> or <b>V9H-IAB</b> (2-ports) is used.</p>
Sample inlet	<p><b>Sample inlet</b> turns the Sample inlet valve to the selected position.</p>
Injection valve	<p><b>Injection valve</b> sets the Injection valve to the selected position. The instruction gives an injection mark in the chromatogram when the inlet valve switches to <b>Inject</b> or <b>Direct Inject</b>.</p> <p><b>Note:</b>            Sample flow refers to the flow that enters the injection valve via <b>SaP</b> port.</p>
Column position	<p><b>Column position</b> turns the Column valve to the position specified in the parameter <b>Position</b>.</p>
pH valve	<p><b>pH valve</b> sets the pH cell and the 0.2 MPa restrictor in positions inline or offline.</p> <p>The pH valve also has a calibration position. This position is only available when performing calibration of the pH monitor (In <b>System control</b> select <b>System:Calibrate</b>). The calibration position can also be used to fill the pH cell with storage solution since the pH valve is in open position.</p> <p><b>Note:</b></p> <ul style="list-style-type: none"> <li>• It is not possible to turn the pH valve during any type of fractionation as it affects the delay volume.</li> <li>• The <b>pH valve</b> instruction can be given during the delay volume of the different stop fractionation instructions, but it is executed only after the set delay volume has been collected.</li> </ul>
Outlet valve	<p><b>Outlet valve</b> turns the Outlet valve to the selected position. The instruction gives a mark in the chromatogram when the valve is switched to the selected position.</p>

Instruction name	Description
Loop valve	<b>Loop valve</b> turns the Loop valve to the selected position.
Mixer valve	<b>Mixer valve</b> turns the Mixer valve to the selected position.  <b>Note:</b> <i>Setting Mixer valve in <b>by-pass</b> position makes it possible to use System pump A for direct loading of the sample onto the column.</i>
Versatile valve X	<b>Versatile valve X</b> turns the Versatile valve number X to the selected position.  <b>Note:</b> <i>Four sets of positions are available. In positions <b>1-3</b> and <b>2-4</b> only a single flow channel can be used. In positions <b>1-4 &amp; 2-3</b> and <b>1-2 &amp; 3-4</b> the flow can be directed through two channels simultaneously.</i>
Inlet valve (X1)	Instruction <b>Inlet valve X1</b> turns the extra valve to the selected position. The extra valve is a basic 8 port valve, without air sensor, to be used for general applications.
Inlet valve (X2)	Instruction <b>Inlet valve X2</b> turns the extra valve to the selected position. The extra valve is a basic 8 port valve, without air sensor, to be used for general applications.
Injection mark	<b>Injection mark</b> sets an injection mark in the chromatogram at the point where this instruction is executed.  <b>Note:</b> <i>The instruction is useful when the sample is loaded onto the column by the system pump.</i>

## 9.9.3 Manual instructions - Monitors

The table below describes the monitor related manual instructions available for ÄKTA pure.

Instruction name	Description
Auto zero UV	<b>Auto zero UV</b> sets the UV signals from U9-M or U9-L to 0 mAU.
Auto zero UV 2nd	<b>Auto zero UV 2nd</b> sets the UV signal from UL-9, 2nd to 0 mAU.
Wavelength	<p><b>Wavelength</b> sets the wavelengths for UV monitor U9-M. The corresponding curves in the chromatogram are marked with the set wavelengths.</p> <p><b>Note:</b></p> <ul style="list-style-type: none"> <li>The instruction is available when UV monitor U9-M (variable) is selected in the component list. For best performance, do not use more wavelengths than necessary for the application.</li> <li>At low wavelengths, the eluent can have absorbance of its own.</li> </ul>
Noise reduction UV	<b>Noise reduction UV</b> filters the noise in the UV signal from UV monitor U9-M or U9-L. A column-specific averaging time is set automatically when a column is defined in a method run and <b>Averaging time</b> is set as a variable.
Noise reduction UV 2nd	<b>Noise reduction UV 2nd</b> filters the noise in the UV monitor signal from U9-L, 2nd. A column-specific averaging time is set automatically when a column is defined in a method run and <b>Averaging time</b> is set as a variable.
UV lamp	Sets the UV lamp ON or OFF. Default is ON. The UV lamp is turned ON when the system changes state to RUN, HOLD, or WASH.
UV lamp 2nd	Sets the UV lamp 2nd ON or OFF. Default is ON. The UV lamp 2nd is turned ON when the system changes state to RUN, HOLD, or WASH.
Relative scale cond	<p><b>Relative scale cond</b> facilitates monitoring of a gradient, for which the user sets the conductivity values for 0% and 100%. The <b>Relative scale cond</b> can be set in ascending manner (0% for low and 100% for high conductivity) or in descending manner (0% for high and 100% for low conductivity).</p> <p><b>Note:</b></p> <p>The <b>Relative scale cond</b> in descending manner is especially useful for conductivity visualization in RPC and HIC, where the conductivity curve is reversed compared to the concentration curve (i.e., high conductivity at 0% B and low conductivity at 100% B).</p>



## 9.9.4 Manual instructions - Fraction collection

The table below describes the fraction collection related manual instructions available for ÄKTA pure.

Instruction name	Description
Fractionation	<b>Fractionation</b> is used when collecting fractions with a fraction collector.
Stop fractionation	<b>Stop fractionation</b> ends the fractionation after the set delay volume (specified in <b>System Settings:Tubing and Delay volumes</b> ) has been collected. The outlet valve is then turned to position <b>Waste</b> .  <b>Note:</b> <i>If <b>Stop fractionation</b> is issued when both <b>Fractionation</b> and <b>Peak fractionation</b> are active, fractionation is stopped after the set delay volume has been collected. The outlet valve remains in position <b>Frac</b> and peak fractionation continues.</i>
Peak fractionation	<b>Peak fractionation</b> enables collection of only those peaks that fulfill the conditions set in the <b>Peak fractionation parameters</b> instruction.
Stop peak fractionation	<b>Stop peak fractionation</b> ends the peak fractionation after the set delay volume (specified in <b>System Settings:Tubing and Delay volumes</b> ) has been collected. The outlet valve is then turned to position <b>Waste</b> .
Last tube filled	Only for Fraction collector F9-C. <b>Last tube filled</b> sets the action to perform after the fraction collector fills the last tube of the run: pause the fractionation, direct the flow to one of the outlet ports of the outlet valve or direct the flow to waste.
Reset frac number	Only for Fraction collector F9-R. Sets fraction numbers to restart from 1. The restart occurs when the instruction is issued. The instruction overrides the continuous numbering mode if <b>Fractionation numbering mode</b> is set to <b>Continue</b> in <b>System Settings</b> .
Feed tube	Fraction collector F9-C: <b>Feed tube</b> moves the fractionation arm to the position specified by the parameter <b>Start position</b> , after the set delay volume has been collected. A fraction mark is given in the chromatogram.  Fraction collector F9-R: <b>Feed tube</b> moves the tube rack forward one tube after the set delay volume has been collected and a fraction mark is set. When fractionation or peak fractionation is not ongoing, <b>Feed tube</b> moves the rack instantly and no fraction mark is set.

Instruction name	Description
Fractionation numbering mode	<p>Only for Fraction collector F9-R. <b>Fractionation numbering mode</b> determines whether the fraction number is reset at the end of a method or not.</p> <p><b>Note:</b> <i>The default setting is <b>Reset</b>.</i></p>
Fraction collector wash	<p>Only for Fraction collector F9-C. <b>Fraction collector wash</b> is used to wash the fraction collector with the current solution present in the system. The wash flow rate is set in the instruction <b>Wash settings:Fraction collector wash settings</b> and the current inlet positions are used. After the wash, the flow rate and the valve positions automatically go back to their previous settings.</p> <p><b>Note:</b> <i><b>Fraction collector wash</b> cannot be executed during any type of fractionation.</i></p>
Reset tube type	<p>Only for Fraction collector F9-C. <b>Reset tube type</b> resets all the tube types in the fraction collector.</p> <p><b>Note:</b> <i>It is not allowed to execute the <b>Reset tube type</b> instruction during fractionation.</i></p>
Frac cleaning position	<p>Only for Fraction collector F9-C. <b>Frac cleaning position</b> enables manual cleaning of the dispenser head. The system is paused and the fractionation arm is moved to the middle front of the interior of the fraction collector. It is then possible to open the door of the fraction collector and manually clean the dispenser head.</p> <p><b>Note:</b> <i>The <b>Frac cleaning position</b> instruction cannot be executed during fractionation.</i></p>
Fraction collector lamp	<p>Only for Fraction collector F9-C. <b>Fraction collector lamp</b> turns the light in the fraction collector on or off.</p>
Cassette configuration	<p>Only for Fraction collector F9-C. <b>Cassette configuration</b> is set to either <b>automatic</b> or <b>manual</b>:</p> <ul style="list-style-type: none"> <li>• Automatic: the fraction collector automatically detects the cassette types present in the fraction collector.</li> <li>• Manual: The fraction collector content is manually set.</li> </ul>
Fractionation frac 2	<p><b>Fractionation frac 2</b> is used when collecting fractions with the second Fraction collector.</p>

Instruction name	Description
Stop fractionation frac 2	<p><b>Stop fractionation frac 2</b> ends the fractionation after the set delay volume for the second Fraction collector (specified in <b>System Settings:Tubing and Delay volumes</b>) has been collected. The outlet valve is then turned to position <b>Waste</b>.</p> <p><b>Note:</b>  <i>If <b>Stop fractionation frac 2</b> is issued when both <b>Fractionation frac 2</b> and <b>Peak fractionation frac 2</b> are active, fractionation is stopped after the set delay volume has been collected. The Outlet valve <b>V9-O</b> or <b>V9H-O</b> remains in position <b>Outlet 10 / Frac 2</b> (or <b>Outlet 1</b> if Outlet valve <b>V9-Os</b> is mounted on the instrument) and peak fractionation in the second Fraction collector continues.</i></p>
Peak fractionation frac 2	<p><b>Peak fractionation frac 2</b> enables collection of only those peaks that fulfill the conditions set in the <b>Peak fractionation parameters</b> instruction.</p>
Stop peak fractionation frac 2	<p><b>Stop peak fractionation frac 2</b> ends the peak fractionation in second Fraction collector after the set delay volume (specified in <b>System Settings:Tubing and Delay volumes</b>) has been collected. The outlet valve is then turned to position <b>Waste</b>.</p>
Reset frac number frac 2	<p>Sets fraction numbers to restart from 1 for the second Fraction collector. The restart occurs when the instruction is issued. The instruction overrides the continuous numbering mode if <b>Fractionation numbering mode frac 2</b> is set to <b>Continue</b> in <b>System Settings</b>.</p>
Feed tube frac 2	<p>During fractionation or peak fractionation the instruction <b>Feed tube frac 2</b> moves the second Fraction collector tube rack forward one tube after the set delay volume has been collected and a fraction mark is set. When fractionation or peak fractionation is not ongoing, <b>Feed tube frac 2</b> moves the rack instantly and no fraction mark is set.</p>
Fractionation in outlet valve	<p>Applicable if no fraction collector is used. <b>Fractionation in outlet valve</b> enables fractionation via the outlet valve. When the set fraction size/outlet has been collected, the outlet valve turns to the next position. A fraction mark is set in the chromatogram for each new outlet position. If using Outlet valve <b>V9-Os</b> or <b>V9H-Os</b> (1-outlet), only one fraction can be collected via <b>Outlet 1</b> position.</p>
Stop frac in outlet valve	<p>Applicable if no fraction collector is used. <b>Stop frac in outlet valve</b> ends the fractionation in outlet valve after the set delay volume (specified in <b>System Settings:Tubing and Delay volumes</b>) has been collected. The outlet valve is then turned to position <b>Waste</b>.</p>

Instruction name	Description
Peak frac in outlet valve	Applicable if no fraction collector is used. <b>Peak frac in outlet valve</b> enables collection of only those peaks that fulfill the conditions set in <b>Peak fractionation parameters</b> . When the set fraction size/outlet has been collected, the outlet valve turns to the next position. A fraction mark is set in the chromatogram for each new outlet position. If Outlet valve <b>V9-Os</b> or <b>V9H-Os</b> (1-outlet) is used, only one peak can be collected via <b>Outlet 1</b> position.
Stop peak frac in outlet valve	Applicable if no fraction collector is used. <b>Stop peak frac in outlet valve</b> ends the peak fractionation in outlet valve after the set delay volume (specified in <b>System Settings:Tubing and Delay volumes</b> ) has been collected. The outlet valve is then turned to position <b>Waste</b> .
Peak fractionation parameters	<b>Peak fractionation parameters</b> sets the detection parameters for peak collection, i.e. it determines when a peak starts and ends. This information is used by the instructions <b>Peak fractionation</b> , <b>Peak fractionation frac 2</b> and <b>Peak frac in outlet valve</b> in order to start/end the peak collection.

## 9.9.5 Manual instructions - I/O-box

The table below describes the I/O-box related manual instructions available for ÄKTA pure.

Instruction name	Description
Auto zero analog in X	<b>Auto zero analog in X</b> sets the value of the analog signal in the analog port number X to 0 mV.
Reset auto zero analog in X	<b>Reset auto zero analog in X</b> sets the signal in analog port number X to its current value, i.e. the actual voltage in the analog port number X.
Noise reduction analog in X	<b>Noise reduction analog in X</b> filters the noise in the analog signal in port number X.
Digital out X	<b>Digital out X</b> sets the value of the signal sent out by digital port number X to either 0 or 1. The default value is 1.
Pulse digital out X	<b>Pulse digital out X</b> generates a pulsed signal in digital port number X. The signal changes from the initial state (0 or 1) to the opposite state and returns to the initial state after the defined length of time.
Configure analog out X	<b>Configure analog out X</b> enables the user to send one of the predefined signals (UV signal, conductivity, temperature, pH or concentration of eluent B) to the analog out port number X, and also to set the range of that signal.

## 9.9.6 Manual instructions - Alarms

The table below describes the alarm related manual instructions available for ÄKTA pure.

Instruction name	Description
Alarm system pressure	<p><b>Alarm system pressure</b> sets the alarm limits for the system pressure. When enabled and the system pressure falls outside the set pressure limits, an alarm will be triggered and the method will be paused. Default values for the alarm limits are set by the values in the column list when a column is selected in the method and <b>Alarm system pressure</b> is set as a variable. <b>Low alarm</b> is only triggered if the pressure first exceeds the <b>Low alarm</b> limit for ten seconds continuously and then falls below the <b>Low alarm</b> limit.</p> <p><b>Note:</b>  <i>Setting the <b>Low alarm</b> or the system flow rate to 0 deactivates the low pressure alarm.</i></p>
Alarm sample pressure	<p><b>Alarm sample pressure</b> sets the alarm limits for the sample pressure. When enabled and the pressure falls outside the set pressure limits, an alarm will be triggered and the method will be paused. <b>Low alarm</b> is only triggered if the pressure first exceeds the <b>Low alarm</b> limit for ten seconds continuously then falls below the <b>Low alarm</b> limit.</p> <p><b>Note:</b>  <i>Setting the <b>Low alarm</b> to 0 deactivates the low pressure alarm.</i></p>
Alarm delta column pressure	<p><b>Alarm delta column pressure</b> sets the alarm limits for the delta column pressure (pre-column pressure minus post-column pressure). When enabled and the delta column pressure falls outside the set pressure limits, an alarm will be triggered and the method will be paused. <b>Low alarm</b> is only triggered if the pressure first exceeds the <b>Low alarm</b> limit for ten seconds continuously then falls below the <b>Low alarm</b> limit.</p> <p><b>Note:</b></p> <ul style="list-style-type: none"> <li>• <i>Setting the <b>Low alarm</b> to 0 deactivates the low pressure alarm.</i></li> <li>• <i>Instruction <b>Alarm delta column pressure</b> is available only when Column valve <b>V9-C</b> or <b>V9H-C</b> (5-columns) is selected in the component list.</i></li> </ul>

Instruction name	Description
Alarm pre column pressure	<p><b>Alarm pre column pressure</b> sets the alarm limits for the pre column pressure. When enabled and the pre column pressure falls outside the set pressure limits, an alarm is issued and the method will be paused. Default values for the alarm limits are set by the values in the column list when a column is selected in the method and <b>Alarm pre column pressure</b> is set as a variable. <b>Low alarm</b> is only triggered if the pressure first exceeds the <b>Low alarm</b> limit for ten seconds continuously then falls below the <b>Low alarm</b> limit.</p> <p><b>Note:</b>  <i>Setting the <b>Low alarm</b> to 0 deactivates the low pressure alarm.</i></p>
Alarm UV	<p><b>Alarm UV</b> enables or disables the alarm for the UV signal. When enabled, it sets the alarm limits for the UV signal from UV monitor U9-L. When the UV signal falls outside the set limits, an alarm will be triggered and the method will be paused.</p>
Alarm UV1	<p><b>Alarm UV1</b> enables or disables the alarm for the UV 1 signal from UV monitor U9-M. When enabled, it sets the alarm limits for the UV 1 signal from UV monitor U9-M. When the UV signal falls outside the set limits, an alarm is issued and the method will be paused.</p> <p><b>Note:</b>  <i>It is not possible to set an alarm signal for the UV 2 or UV 3 signals from UV monitor U9-M.</i></p>
Alarm UV 2nd	<p><b>Alarm UV 2nd</b> enables or disables the alarm for the UV signal from UV monitor U9-L, 2nd. When enabled, it sets the alarm limits for the UV signal from U9-L, 2nd. When the UV signal falls outside the set limits, an alarm will be triggered and the method will be paused.</p>
Alarm conductivity	<p><b>Alarm conductivity</b> enables or disables the conductivity alarm. When enabled, it sets the alarm limits for the conductivity signal. When the conductivity falls outside the set limits, an alarm will be triggered and the method will be paused.</p>
Alarm pH	<p><b>Alarm pH</b> enables or disables the pH alarm. When enabled, it sets the alarm limits for the pH signal. When the pH falls outside the set limits, an alarm will be triggered and the method will be paused.</p>
Alarm inlet A air sensor	<p><b>Alarm inlet A air sensor</b> enables or disables the air sensor alarm for the built-in air sensor at inlet A. If the alarm is enabled and air is detected, an alarm will be triggered and the method will be paused.</p>

Instruction name	Description
Alarm inlet B air sensor	<b>Alarm inlet B air sensor</b> enables or disables the air sensor alarm for the built-in air sensor at inlet B. If the alarm is enabled and air is detected, an alarm will be triggered and the method will be paused.
Alarm sample inlet air sensor	<b>Alarm sample inlet air sensor</b> enables or disables the air sensor alarm for the built-in air sensor at the sample inlet. If the alarm is enabled and air is detected, an alarm will be triggered and the method will be paused.
Alarm external air sensor X	<b>Alarm external air sensor X</b> enables or disables the alarm for the optional air sensor number X. If the alarm is enabled and air is detected, an alarm will be triggered and the method will be paused.
Alarm analog in X	<b>Alarm analog in X</b> enables or disables the alarm for the analog signal in port number X. When enabled, it sets the alarm limits for the analog signal. If the alarm is enabled and the analog signal falls outside the set limits, an alarm will be triggered and the method will be paused.
Alarm digital in X	<b>Alarm digital in X</b> enables or disables the alarm for the signal in digital port number X. The alarm can be triggered by either of the signal values, 0 or 1. If the alarm is enabled and the condition set in ' <b>Value</b> ' occurs, an alarm will be triggered and the method will be paused.



## 9.9.7 Manual instructions - Wash settings

The table below describes the wash related manual instructions available for ÄKTA pure.

Instruction name	Description
System wash settings	<p><b>System wash settings</b> sets the flow rate used for <b>System wash</b>.</p> <p><b>Note:</b></p> <ul style="list-style-type: none"> <li>• The volume for system wash is set in the <b>System wash</b> instruction.</li> <li>• The flow rate should not exceed 10 ml/min if narrow inlet tubing (I.D. 0.75 mm) is used.</li> <li>• Adjust the flow rate during the system wash so that the system pressure does not exceed 2 MPa.</li> </ul>
System pump wash settings	<p><b>System pump wash settings</b> sets the flow rate and wash volume used during system pump washes.</p> <p><b>Note:</b></p> <p>The flow rate should not exceed 10 ml/min if narrow inlet tubing (I.D. 0.75 mm) is used.</p>
Sample pump wash settings	<p><b>Sample pump wash settings</b> sets the flow rate and wash volume used during sample pump washes.</p>
Fraction collector wash settings	<p><b>Fraction collector wash settings</b> sets the flow rate during <b>Fraction collector wash</b>.</p>
Mixer by-pass wash settings	<p><b>Mixer by-pass wash settings</b> sets the flow rate used during <b>Mixer by-pass wash</b> and defines wash volumes for mixer by-pass wash options.</p> <p><b>Note:</b></p> <p>The flow rate should not exceed 10 ml/min if narrow inlet tubing (I.D. 0.75 mm) is used.</p>
Loop wash settings	<p><b>Loop wash settings</b> sets the flow rate used during <b>Loop wash</b>.</p> <p><b>Note:</b></p> <ul style="list-style-type: none"> <li>• The volume for system wash is set in the <b>Loop wash</b> instruction.</li> <li>• The flow rate should not exceed 10 ml/min if narrow inlet tubing (I.D. 0.75 mm) is used.</li> </ul>

## 9.9.8 Manual instructions - Watch parameters

The table below describes the watch parameter instructions available for ÄKTA pure.

Instruction name	Description
Watch UV parameters	<b>Watch UV parameters</b> sets the accepted signal fluctuation and <b>Delta peak</b> limit of the UV signal for some of the tests in the <b>Watch</b> and <b>Hold until</b> instructions.
Watch UV 2nd parameters	<b>Watch UV 2nd parameters</b> sets the accepted signal fluctuation and <b>Delta peak</b> limit of the UV 2nd signal for some of the tests in the <b>Watch</b> and <b>Hold until</b> instructions.
Watch cond parameters	<b>Watch cond parameters</b> sets the accepted fluctuation and <b>Delta peak</b> limit of the conductivity signal for some of the tests in the <b>Watch</b> and <b>Hold until</b> instructions.
Watch pH parameters	<b>Watch pH parameters</b> sets the value for the accepted fluctuation of the pH signal used for the test <b>Stable signal</b> in the instructions <b>Watch</b> and <b>Hold until</b> .
Watch flow parameters	<b>Watch flow parameters</b> sets the value for the accepted fluctuation of the flow rate signal used for the test <b>Stable signal</b> in the instructions <b>Watch</b> and <b>Hold until</b> with signal <b>System flow</b> .
Watch pressure parameters	<b>Watch pressure parameters</b> sets the value for the accepted fluctuation of the pressure signals used for the test <b>Stable signal</b> in the instructions <b>Watch</b> and <b>Hold until</b> .
Watch analog in parameters	<b>Watch analog in parameters</b> sets the accepted signal fluctuation and <b>Delta peak</b> limit of the analog signal for some of the tests in the <b>Watch</b> and <b>Hold until</b> instructions.

## 9.9.9 Manual instructions - Advanced

The table below describes the advanced manual instructions available for ÄKTA pure.

Instruction name	Description
Pressure control parameters	<p>By using <b>Pressure control</b> the method can be run with the set flow rate without the risk of method stop due to pressure alarm. Pressure control is enabled in the instruction <b>System flow</b> or <b>Sample flow</b>. <b>Pressure control parameters</b> provides the P and I factors used in the regulator and can be adjusted for different columns.</p> <p>Pressure control min flow rate can be set either as volumetric or as linear flow. A column type must be selected before using linear flow.</p>
Constant pressure flow	<p><b>Constant pressure flow</b> enables column packing at constant pressure. The system pump automatically adjusts the flow rate within the specified <b>Minimum allowed flow rate – Maximum allowed flow rate</b> range. The goal is to reach and keep the set <b>Pressure</b> at the selected <b>Pressure sensor</b> using the P and I factors set in the <b>Constant pressure flow parameters</b> instruction. The total volume is continuously updated using the actual flow rate.</p> <p>Both pressure control flow rates can be set either as volumetric or as linear flow. A column type must be selected before using linear flow.</p> <p><b>Note:</b></p> <ul style="list-style-type: none"> <li>• When <b>Constant pressure flow</b> is used, the P and I factors set in the <b>Constant pressure flow parameters</b> instruction are used to control the pressure, instead of the P and I values set in the <b>Pressure control parameters</b> instruction.</li> <li>• Pressure sensor <b>Delta column pressure</b> is available only when column valve <b>V9-C</b> or <b>V9H-C</b> (5-columns) is selected in the component list.</li> </ul>
Constant pressure flow parameters	<p><b>Constant pressure flow parameters</b> sets the values for the P and I factors needed to keep a constant pressure by varying the flow rate. The signal used for pressure control is set in the instruction <b>Constant pressure flow</b>.</p>

Instruction name	Description
Column packing flow	<p><b>Column packing flow</b> is used to set flow rates over 25 ml/min and 150 ml/min for ÄKTA pure 25 and ÄKTA pure 150, respectively. Both A and B pumps are used to generate the flow, making it possible to set flow rates up to 50 ml/min and 300 ml/min for ÄKTA pure 25 and ÄKTA pure 150, respectively. Flow rate can be set either as volumetric or as linear flow. A column type must be selected before using linear flow.</p> <p>Before executing the <b>Column packing flow</b> instruction it is important to:</p> <ul style="list-style-type: none"> <li>• Immerse inlet tubing <b>A1</b> and <b>B1</b> in the same buffer</li> <li>• Disconnect the column outlet tubing from the Column valve and place the tubing in a waste vessel</li> </ul> <p><b>Note:</b>  <i>When running <b>Column packing flow</b> only isocratic runs can be performed, gradients cannot be generated.</i></p>
Delay volume: Monitor to outlet valve	<p><b>Delay volume: Monitor to outlet valve</b> is used to define the delay volume between the monitor and the Outlet valve. The instruction is used to make sure that the collected fractions correspond to the fractions indicated in the chromatogram. The delay volume must be changed when changing tubing to another i.d. or length or when removing or adding components.</p>
Delay volume: Monitor to frac	<p><b>Delay volume: Monitor to frac</b> is used to define the delay volume between the monitor and the Fraction collector. The instruction is used to make sure that the collected fractions correspond to the fractions indicated in the chromatogram. The instruction is available only when the Fraction collector is selected in the component list.</p>
Delay volume: Monitor to frac 2	<p><b>Delay volume: Monitor to frac 2</b> is used to define the delay volume between the monitor and the second Fraction collector. The instruction is used to make sure that the collected fractions correspond to the fractions indicated in the chromatogram. The instruction is available only when the second Fraction collector is selected in the component list.</p>
Start volume count	<p><b>Start volume count</b> starts the volume counter function. The counted volume is saved into a memory.</p> <p>This instruction is best used in combination with <b>Watch</b> instructions.</p>

Instruction name	Description
Stop volume count	<p><b>Stop volume count</b> stops the volume counter function. The counted volume is stored in the memory and can be recalled with the instruction <b>Hold counted volume</b>. The counted volume can also be recalled in following runs and is stored until a new <b>Stop volume count</b> instruction is issued.</p> <p>This instruction is best used in combination with <b>Watch</b> instructions.</p>
Hold counted volume	<p><b>Hold counted volume</b> sets the system to <b>Hold</b>. The system will remain in the state <b>Hold</b> until the accumulated volume reaches the volume stored by the instructions <b>Start volume count / Stop volume count</b>.</p>
Method progressing flow	<p><b>Method progressing flow</b> defines the flow from which the volume base is calculated. When set to <b>Automatic</b>, the position of the injection valve determines if the system flow or the sample flow is used.</p>

## 9.9.10 Manual instructions - Other

The table below describes the other manual instructions available for ÄKTA pure.

Instruction name	Description
Set mark	<b>Set mark</b> inserts a mark into the current chromatogram with the text entered for the parameter <b>Mark text</b> .
Timer	<b>Timer</b> sets the system to pause or end after a set volume or time has passed. <b>Select base</b> sets the base to either accumulated time or accumulated volume. <b>Timeout</b> sets the volume or time. <b>Action</b> sets the action to perform (pause or end)

## 9.10 Available Run data

The table below lists all available **Run data** for ÄKTA pure.

Run Data	Range/Unit	Description
System state	N/A	Status of connection and run.
Acc. Volume	ml	Total accumulated volume in the current method or manual run.
Block volume	ml	Accumulated volume in the current block (method run only).
Acc. Time	min	Total accumulated time in the current method or manual run.
Block time	min	Accumulated time in the current block (method run only).
Scouting no	N/A	The current scouting number in the scouting scheme.
System flow	0.001 – 50.000 ml/min (ÄKTA pure 25) 0.01 – 300.00 ml/min (ÄKTA pure 150)	The set flow rate of the system pumps.
System linear flow	cm/h	The set flow velocity of the system pumps. Only available if a column is selected.
Sample flow	0.001 – 50.000 ml/min (ÄKTA pure 25) 0.01 – 300.00 ml/min (ÄKTA pure 150)	The set flow rate of the sample pump.
Sample linear flow	cm/h	The set flow velocity of the sample pump. Only available if a column is selected.
Inlet A	A1 - A7	The set position of the inlet valve A.
Inlet B	B1 - B7	The set position of the inlet valve B.
Inlet S	S1 - S7, buff	The set position of the sample inlet valve.
Conc B	0.0 – 100.0 %B	The set concentration B or the current value during a gradient.
Mixer valve	N/A	The set position of the Mixer valve.
Injection	N/A	The set position of the Injection valve.
Loop position	N/A	The set position of the Loop valve.

Run Data	Range/Unit	Description
Column position	N/A	The set position of the Column valve.
Column flow direction	N/A	The set flow direction position of the Column valve <b>V9-C</b> , Column valve <b>V9H-C</b> , Column valve <b>V9-Cs</b> and <b>V9H-Cs</b> .
System pressure	-1.00 – 20.00 MPa (ÄKTA pure 25) -1.00 – 5.00 MPa (ÄKTA pure 150)	The system pressure signal (at the system pumps).
Sample pressure	-1.00 – 10.00 MPa (ÄKTA pure 25) -1.00 – 5.00 MPa (ÄKTA pure 150)	The sample pressure signal (at the sample pump).
PreC pressure	-1.00 – 20.00 MPa (ÄKTA pure 25) -1.00 – 5.00 MPa (ÄKTA pure 150)	The pre-column pressure signal.
DeltaC pressure	-1.00 – 20.00 MPa (ÄKTA pure 25) -1.00 – 5.00 MPa (ÄKTA pure 150)	The delta-column pressure signal.
PostC pressure	-1.00 – 20.00 MPa (ÄKTA pure 25) -1.00 – 5.00 MPa (ÄKTA pure 150)	The post-column pressure signal.
UV	-6000.000 – 6000.000 mAu	The UV absorbance signal of the U9-L monitor.
UV 1	-6000.000 – 6000.000 mAU	The first UV/Vis absorbance signal of the U9-M monitor.
UV 2	-6000.000 – 6000.000 mAU	The 2nd UV/Vis absorbance signal of the U9-M monitor.
UV 3	-6000.000 – 6000.000 mAU	The 3rd UV/Vis absorbance signal of the U9-M monitor.
UV 2nd	-6000.000 – 6000.000 mAU	The UV absorbance signal of the second U9-L monitor.
Cond	0.00 – 999.99 mS/cm	The conductivity signal.
% Cond	0.0 – 100.0 %	The conductivity signal as a percentage of a set range.



Run Data	Range/Unit	Description
Cond temp	0.0 – 99.0 °C	The temperature signal (in the conductivity flow cell).
pH	0.00 – 14.00	The pH signal.
pH valve	N/A	The set position of the pH valve.
Outlet	N/A	The set position of the outlet valve.
Frac position	N/A	The current tube position of the fraction collector.
Frac 2 position	N/A	The current tube position of the fraction collector 2.
Inlet valve X1	N/A	The set position of the X1 valve.
Inlet valve X2	N/A	The set position of the X2 valve.
Versatile valve	N/A	The set position of the versatile valve.
Versatile valve 2	N/A	The set position of the versatile valve 2.
Versatile valve 3	N/A	The set position of the versatile valve 3.
Versatile valve 4	N/A	The set position of the versatile valve 4.
Air inlet A	No air, Air	The current state of the air alarm for the integrated air sensor in inlet valve A.
Air inlet B	No air, Air	The current state of the air alarm for the integrated air sensor in inlet valve B.
Air inlet S	No air, Air	The current state of the air alarm for the integrated air sensor in inlet valve IS.
Ext. air sensor, to Ext. air sensor 4	No air, Air	The current state of the air alarm for the external air sensors.
Analog in 1, to Analog in 4	-2000.0 – 2000.0 mV	The I/O-box analog input signals.
Digital in 1, to Digital in 8	0, 1	The I/O-box digital input signals.
Digital out 1, to Digital out 8	0, 1	The set value of the I/O-box digital output signals.

## 9.11 Available Curves

The table below lists all available **Curves** for ÄKTA pure.

Curve	Range	Sampling frequency	Description
UV 1	-6000.000 – 6000.000 mAU	10 Hz	The first UV/Vis absorbance signal of the U9-M monitor.
UV 2	-6000.000 – 6000.000 mAU	2 Hz	The 2nd UV/Vis absorbance signal of the U9-M monitor.
UV 3	-6000.000 – 6000.000 mAU	2 Hz	The 3rd UV/Vis absorbance signal of the U9-M monitor.
Cond	0.00 – 999.99 mS/cm	5 Hz	The conductivity signal.
% Cond	0.0 – 100.0 %	1 Hz	The conductivity signal as a percentage of a set range.
Conc B	0.0 – 100.0 %	1 Hz	The set concentration B or the current value during a gradient.
System flow	0.001 – 50.000 ml/min (ÄKTA pure 25) 0.01 – 300.00 ml/min (ÄKTA pure 150)	1 Hz	The set flow rate of the system pumps.
System linear flow	cm/h	1 Hz	The set flow velocity of the system pumps. Only available if a column is selected.
Sample flow	0.001 – 50.000 ml/min (ÄKTA pure 25) 0.01 – 300.00 ml/min (ÄKTA pure 150)	1 Hz	The set flow rate of the sample pump.
Sample linear flow	cm/h	1 Hz	The set flow velocity of the sample pump. Only available if a column is selected.
PreC pressure	-1.00 – 20.00 MPa (ÄKTA pure 25) -1.00 – 5.00 MPa (ÄKTA pure 150)	1 Hz	The pre-column pressure signal.
DeltaC pressure	-1.00 – 20.00 MPa (ÄKTA pure 25) -1.00 – 5.00 MPa (ÄKTA pure 150)	1 Hz	The delta-column pressure signal.

Curve	Range	Sampling frequency	Description
pH	0.00 – 14.00	1 Hz	The pH signal.
UV	-6000.000 – 6000.000 mAU	10 Hz	The UV absorbance signal of the U9-L monitor.
UV 2nd	-6000.000 – 6000.000 mAU	10 Hz	The UV absorbance signal of the second U9-L monitor.
System pressure	-1.00 – 20.00 MPa (ÄKTA pure 25) -1.00 – 5.00 MPa (ÄKTA pure 150)	10 Hz	The system pressure signal (at the system pumps).
Sample pressure	-1.00 – 10.00 MPa (ÄKTA pure 25) -1.00 – 5.00 MPa (ÄKTA pure 150)	10 Hz	The sample pressure signal (at the sample pump).
PostC pressure	-1.00 – 20.00 MPa (ÄKTA pure 25) -1.00 – 5.00 MPa (ÄKTA pure 150)	1 Hz	The post-column pressure signal.
Cond temp	0.0 – 99.0 °C	0.5 Hz	The temperature signal (in the conductivity flow cell).
Analog in 1, to Analog in 4	-2000.0 – 2000.0 mV	10 Hz	The I/O-box analog input signals.
UV cell path length	0.2, 0.5 cm	1 Hz	The nominal cell path length of the U9-L monitor.
UV cell path length	0.05, 0.2, 1.0 cm	1 Hz	The nominal cell path length of the U9-M monitor.
UV cell path length 2nd	0.2, 0.5 cm	1 Hz	The nominal cell path length of the 2nd U9-L monitor.
Digital in 1, to Digital in 8	0, 1	10 Hz	The I/O-box digital input signals.
Digital out 1, to Digital out 8	0, 1	10 Hz	The I/O-box digital output signals.

## 9.12 Injection volumes and peak broadening

The width of peaks at the fraction collector is influenced by the following:

- the properties of the column,
- the dimensions of the tubing,
- the dimensions of the modules in the flow path, and
- fluid dynamics.

Initial sample volume affects the peak width in gel filtration (GF) chromatography and other isocratic techniques. A sample zone is broadened during passage through a GF column so that the sample is diluted and the resolution decreases with increasing sample volume. Sample volume does not however affect the resolution in adsorption chromatography techniques such as affinity chromatography (AC), ion exchange chromatography (IEX), and hydrophobic interaction chromatography (HIC) if the retention factor  $k$  is high.

The effect of peak broadening in the system from sample injection to peak detection (including dilution on the column) is apparent in the chromatogram from the UV monitor, but broadening from the UV monitor to fraction collection is not visible in the chromatogram. This "hidden" effect is more pronounced for smaller peak volumes.

Narrow and short tubing reduces peak broadening. However, narrow tubing also increases the back pressure. See for recommendations on tubing dimensions for prepacked columns.

---

## 9.13 Delay volumes

### Introduction

A number of methods, both theoretical and experimental, exist for determining the delay volume of a system. The easiest and recommended method is to perform a theoretical determination. Delay volumes for standard configurations are listed in [Standard delay volumes, on page 495](#).

### Explanation of delay volume

The delay volume is the volume between the detector and the fraction collector or outlet that is used. The illustration below shows an example of the delay volume between the UV/Vis monitor and the fraction collector.

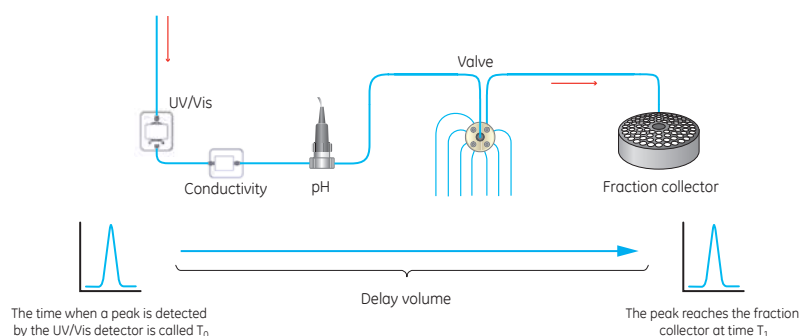

### Theoretical determination of delay volumes

A theoretical determination is performed as described in the steps below:

Step	Action
1	Identify all components in the system flow path that contribute to the delay volume of interest.
2	Determine the internal volumes of all hardware modules and tubing, see <a href="#">Section 9.14 Component volumes, on page 498</a> for information about theoretical module volumes and <a href="#">Section 9.3 Tubing and connectors, on page 420</a> for information about tubing lengths and dimensions.
3	To obtain the total delay volume, sum up half of the flow cell volume of the monitor used (that is, the UV or UV/Vis monitor) with all volumes of tubing and modules that are located after the monitor in the flow path.

**Note:**

For pH-valve **V9-pH** and **V9H-pH** always use the volume for the valve in bypass position. The system automatically adds the volumes for the flow restrictor and the pH flow cell when if they are part of the system.

### Set the delay volume in UNICORN

Follow the instructions below to set the delay volume between the UV monitor and the Outlet valve and between the UV monitor and the Fraction collector.

Step	Action
------	--------

- |   |  |
|---|--|
| 1 | Select <b>System:Settings</b> in the <b>System Control</b> module.<br><i>Result:</i> The <b>System Settings</b> dialog opens.  |
| 2 | <ul style="list-style-type: none"><li>• Select <b>Tubing and Delay Volumes</b> and select <b>Delay volume: Monitor to outlet valve</b>.</li><li>• Type in the volume in the <b>Volume</b> field and click <b>OK</b>.</li></ul> |

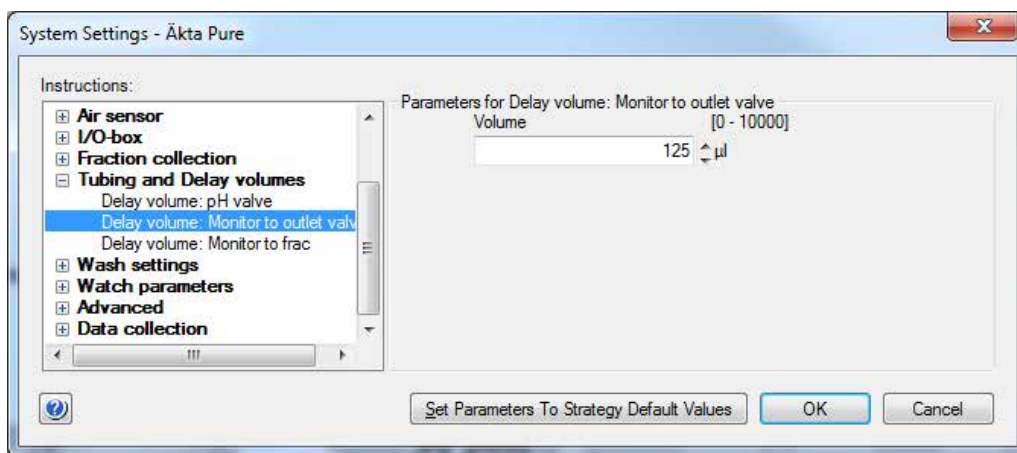

- |   |  |
|---|--|
| 3 | In the <b>System Settings</b> dialog: <ul style="list-style-type: none"><li>• Select <b>Delay volume: Monitor to outlet valve</b> or <b>Monitor to frac</b> according to the configuration you are using.</li><li>• Type in the volume in the <b>Volume</b> field and click <b>OK</b>.</li></ul> |
|---|--|

**Note:**

The system will use the delay volume appropriate to the configuration used and ignore other settings (e.g. the value for **Monitor to outlet valve** will be ignored if you are using a fraction collector). It is however recommended to set all delay volumes so that the volumes remain correct if you change fractionation method.

## Standard delay volumes

The table below lists the delay volumes for standard configurations using the available tubing kits with and without a pH valve and using tubing of standard length from the outlet valve to the fraction collector. The values are based on the flow cells for UV monitor **U9-M**. When using **U9-L**, add 9 µl for the 2 mm flow cell and 4 µl for the 5 mm flow cell. The values for delay volume Monitor to frac F9-C assume that the internal tubing of Fraction collector F9-C has the same inner diameter as the tubing kit.

### Delay volumes ÄKTA pure 25

Tubing kit	pH valve V9-pH	Delay volume pH valve restrictor	Delay volume UV monitor to point of collection of eluent		
			Delay volume Monitor to outlet valve	Delay volume Monitor to frac F9-R	Delay volume Monitor to frac F9-C
0.25	No	N/A	66 µl	86 µl	214 µl
0.25	Yes	25 µl	77 µl	96 µl	225 µl
0.5 (standard)	No	N/A	125 µl	205 µl	435 µl
0.5 (standard)	Yes	48 µl	152 µl	231 µl	462 µl
0.75	No	N/A	223 µl	400 µl	803 µl
0.75	Yes	88 µl	277 µl	454 µl	857 µl
1.0	No	N/A	361 µl	675 µl	1319 µl
1.0	Yes	143 µl	452 µl	766 µl	1410 µl

### Delay volumes ÄKTA pure 150

Tubing kit	pH valve V9H-pH	Delay volume pH valve restrictor	Delay volume UV monitor to point of collection of eluent		
			Delay volume Monitor to outlet valve	Delay volume Monitor to frac F9-R	Delay volume Monitor to frac F9-C
0.5	No	N/A	198 µl	278 µl	508 µl
0.5	Yes	60 µl	245 µl	324 µl	555 µl
0.75 (standard)	No	N/A	296 µl	473 µl	876 µl
0.75 (standard)	Yes	100 µl	370 µl	547 µl	950 µl
1.0	No	N/A	434 µl	748 µl	1392 µl
1.0	Yes	155 µl	545 µl	859 µl	1503 µl

- Note:**
- Always set the delay volume from the UV monitor to the point of collection of eluent. Depending on the system configuration, this will be **Delay volume: Monitor to outlet valve** or **Delay volume: Monitor to frac** in the system settings.
  - If the pH valve is mounted, make sure to set the value for the delay volume of the pH valve restrictor. The system automatically adds the volumes for the flow restrictor and the pH flow cell if they are part of the flow path.

## Experimental method for determination of delay volumes

Delay volumes can be determined experimentally for Fraction collector F9-R, but not for Fraction collector F9-C. Instructions for measuring the delay volume using the UV monitor U9-M or UV monitor U9-L are provided below.

Two volumes are used to perform experimental delay volume measurements:

- V1: the volume between the Injection valve and the UV monitor used
- V2: the volume between the Injection valve and the fractionation collector tubing tip

The delay volume is then measured using the following procedure.

Step	Action
1	Check that a flow rate of 1 ml/min is delivered by the pump.  <b>Note:</b> <i>If the flow rate is not correct, check if air bubbles may have entered the pump. Make sure to correct any problems before continuing.</i>
2	Fill a small sample loop, for example 20 µl, with a 1% to 5% acetone solution.
3	Set all components between the monitor and the fraction collector to by-pass mode.
4	Fill the system with water. Run the pump at a flow rate of 1 ml/min and inject the acetone solution as a sample.
5	Note the volume from the point of injection to the maximum of the peak in the chromatogram. This volume is volume measurement V1.
6	Reconfigure the system as follows to include the fraction collector in the flow path before the monitor: <ul style="list-style-type: none"> <li>• Disconnect the two tubing segments from the UV monitor flow cell and connect these with a low-dead-volume connector, a 1/16" female to a 1/16" female union connector.</li> <li>• Mount the fractionation collector tubing tip on the top of the UV monitor flow cell. Connect tubing to the bottom of the UV monitor flow cell and lead this tubing to waste. It is preferable if the waste tubing gives some back pressure as the flow restrictor now is placed before the UV flow cell.</li> </ul>
7	Set the <b>Frac</b> size to a large volume, for example 100 ml, so that the Outlet valve is in the <b>Frac</b> position during the entire run.



Step	Action
8	Start the pump at a flow rate of 1 ml/min and inject the acetone solution.
9	Note the volume from the point of injection to the appearance of the peak in the chromatogram. This volume is volume measurement $V_2$ .
10	To obtain the delay volume: <ul style="list-style-type: none"><li>• Subtract <math>V_1</math> from <math>V_2</math> and</li><li>• add half of the volume of the UV flow cell.</li></ul>

### Use of different monitors for peak fractionation in the same method

If different monitors or detectors are used for peak fractionation in different parts of the same method, the delay volumes have to be set as method instructions for each of the method parts. For example, both an external fluorescence detector and the UV monitor module can be used for peak fractionation.

## 9.14 Component volumes

The table below shows the component volumes of ÄKTA pure.

Component	Volume (µl)
Inlet valve <b>V9-IA, V9-IB</b>	88
Inlet valve <b>V9H-IA, V9H-IB</b>	212
Inlet valve <b>V9-IAB</b>	95
Inlet valve <b>V9H-IAB</b>	116
Sample inlet valve <b>V9-IS</b>	88
Sample inlet valve <b>V9H-IS</b>	212
Inlet valve <b>V9-IX</b>	88
Inlet valve <b>V9H-IX</b>	212
Air sensor <b>L9-1.2</b>	20
Air sensor <b>L9-1.5</b>	35
Pump P9 ( <b>P9-A, and P9-B</b> ) (total volume for two heads including T-connector and check valves)	549
Pump P9H ( <b>P9H A, P9H B, P9H S</b> ) (total volume for two heads including T-connector and check valves)	2163
System pump pressure monitor <b>R9</b>	45
Sample pump pressure monitor <b>R9</b>	45
Sample pump <b>S9</b>	1392
Mixer, 0.6 ml	600
Mixer, 1.4 ml	1400
Mixer, 5 ml	5000
Mixer, 15 ml	15000
Mixer valve <b>V9-M</b>	14
Mixer valve <b>V9H-M</b>	31
Loop valve <b>V9-L</b>	17
Loop valve <b>V9H-L</b>	76
Versatile valve <b>V9-V</b>	14
Versatile valve <b>V9H-V</b>	31
Injection valve <b>V9-Inj</b>	10

Component	Volume (µl)
Injection valve <b>V9H-Inj</b>	23
Column valve <b>V9-C</b>	110
Column valve <b>V9H-C</b>	190
Column valve <b>V9-C2</b>	110
Column valve <b>V9H-C2</b>	190
Column valve <b>V9-Cs</b>	14
Column valve <b>V9H-Cs</b>	31
UV monitor <b>U9-M</b> : Flow cell 0.5 mm	10
UV monitor <b>U9-M</b> : Flow cell 2 mm	11
UV monitor <b>U9-M</b> : Flow cell 10 mm	12
UV monitor <b>U9-L</b> : Flow cell 2 mm	30
UV monitor <b>U9-L</b> : Flow cell 5 mm	15
Conductivity cell	22
Flow restrictor <b>FR-902</b>	10
pH valve <b>V9-pH</b> , in <i>By-pass</i> position	15
pH valve <b>V9H-pH</b> , in <i>By-pass</i> position	35
pH flow cell	76
Flow restrictor <b>FR-902</b> and tubing when mounted on pH valve <b>V9-pH</b>	48
Outlet valve <b>V9-O</b>	9
Outlet valve <b>V9H-O</b>	82
Outlet valve <b>V9-Os</b>	9
Outlet valve <b>V9H-Os</b>	28
Fraction collector F9-C internal tubing (0.5 mm i.d.)	147
Fraction collector <b>F9-C</b> Dispenser head	94

**Note:** The given values for the component volumes of the valves are average values. Depending on the chosen flow path the actual component volume may differ somewhat.

## 9.15 Pressure control

### Introduction

By using the function **Pressure control** to regulate the run, the method can be run with the set flow rate without the risk of method stop due to pressure alarm. If the pressure approaches the pressure limit, for example if the sample has higher viscosity than the buffer, the flow rate is automatically lowered. Pressure control is enabled in the manual instructions **Pumps:System flow** or **Pumps:Sample flow**. The default setting for Pressure Control is **Off**. To enable the function, set what pressure signal to use. It is recommended to use the pre-column pressure. The instruction **Advanced:Pressure control parameters** provides the P and I factors used in the regulator and can be adjusted for different columns, see information further down.

In the Method editor, pressure control is enabled by selecting **Control the flow to avoid overpressure** in the predefined phase **Method settings**.

### Pressure control parameters

The table below describes the factors used for pressure regulation.

Parameter	Description
P factor	Proportional component in PI pressure regulation. Reduces the error between actual and requested target pressure, but may leave a permanent error.
I factor	Integrating component in PI pressure regulation. Eliminates the stationary error from the P factor, but introduces a slight instability that may lead to oscillation in the pressure and the actual flow rate. Set I = 0 to disable the I factor. As a general guide use a small I factor for high pressure columns and a large I factor for low pressure columns, see p. 501 for more recommendations.
Target value for pressure control	Sets the target value for the PI pressure regulation as a percentage of the pressure limit. If the target pressure is too close to the pressure limit there is a risk that a short pressure spike will trigger the pressure alarm. The pressure limit is set in the <b>Alarm pressure</b> instruction. The <b>Alarm pressure</b> used for pressure control depends on the settings in the <b>System flow</b> instruction.
Pressure control min flow rate	If the flow rate is reduced below the value set in <b>Pressure control min flow rate</b> , the method is paused and the system is set to state <b>ALARMS AND ERRORS</b> . <b>Pressure control min flow rate</b> can be set either as volumetric or as linear flow. A column type must be selected before using linear flow.

## Recommended pressure control parameters

The table below contains the recommended values for P and I parameters for different media types.

Column/Media	Recommended P factor	Recommended I factor	Additional information
Default	8	40	N/A
Small soft media columns	8	40	N/A
Large soft <sup>1</sup> media columns	8	300 - 600	A higher I value than the default value is needed to speed up pressure ramp-up times.
Small rigid <sup>2</sup> media columns	8	15	A lower I value than the default value is needed to avoid large fluctuations in pressure or flow rate. As an alternative, try increasing P.
	20	40	

<sup>1</sup> Soft media is defined as all GE separation media, except silica and MonoBeads.

<sup>2</sup> Rigid media is defined as GE separation media that is based on silica and MonoBeads.

## Back pressure

Using narrow tubing between components will improve resolution but will lead to increased back pressure in the system. Narrow tubing after the column will increase the pressure in the column at a given flow rate. Make sure that the pressure sensor limits in the system are set so that the maximum pressure for the column used is not exceeded.

## Additional instructions for avoiding pressure alarms

The instruction **Max flow during valve turn** sets the maximum flow rate used during the turning of the Injection valve and Outlet valve in order to avoid high pressure alarms. If the flow rate passing through the Injection valve or the Outlet valve is higher than the set max flow rate, the valves will only turn after decreasing the flow to the specified flow rate. After the valves have turned, the previous flow rate will be restored. The instruction is found in **System Control: System settings: Advanced**.

## 9.16 Node IDs

### Node ID for core modules

The table below lists the Node ID for the core modules.

Core module	Label	Node ID
System pump A	<b>P9 A / P9H A</b>	0
System pump B	<b>P9 B / P9H B</b>	1
Pressure monitor	<b>R9</b>	0
Mixer	<b>M9</b>	0
Injection valve	<b>V9-Inj / V9H-Inj</b>	4

### Node ID for optional modules

The table below lists the Node ID for the optional modules.

**Note:** The Node IDs of Sample pump S9 and Fraction collector F9-C cannot be changed by the user.

**Note:** The Node IDs for UV monitor U9-M and UV monitor U9-D should only be changed by service personnel.

Module	Label	Node ID
Inlet valve A	<b>V9-IA / V9H-IA</b>	0
Inlet valve B	<b>V9-IB / V9H-IB</b>	1
Inlet valve AB	<b>V9-IAB / V9H-IAB</b>	3
Inlet valve X1	<b>V9-IX / V9H-IX</b>	15
Inlet valve X2	<b>V9-IX / V9H-IX</b>	16
Mixer valve	<b>V9-M / V9H-M</b>	22
Sample inlet valve	<b>V9-IS / V9H-IS</b>	2
Loop valve	<b>V9-L / V9H-L</b>	17
Column valve (5-columns)	<b>V9-C / V9H-C</b>	5
Pre-column pressure monitor	N/A	2
Post-column pressure monitor	N/A	3
Second column valve (5-columns)	<b>V9-C2 / V9H-C2</b>	6
Pre-column pressure monitor	N/A	4
Post-column pressure monitor	N/A	5

Module	Label	Node ID
Column valve (1-column)	V9-Cs / V9H-Cs	7
pH valve	V9-pH / V9H-pH	11
Outlet valve (10-outlets)	V9-O / V9H-O	8
Outlet valve (1-outlet)	V9-Os / V9H-Os	19
Versatile valve	V9-V / V9H-V	20
Versatile valve 2	V9-V / V9H-V	21
Versatile valve 3	V9-V / V9H-V	23
Versatile valve 4	V9-V / V9H-V	24
UV monitor (fixed)	U9-L	0
UV monitor 2nd	U9-L	1
UV monitor (variable)	U9-M	0
UV detector	U9-D	0
Conductivity monitor	C9	0
External air sensor	L9	0
External air sensor 2	L9	1
External air sensor 3	L9	2
External air sensor 4	L9	3
Fraction collector (cassettes)	F9-C	0
Fraction collector (round)	F9-R	0
Fraction collector (round), 2nd	F9-R	1
Sample pump	P9-S / P9H S	2
I/O-box	E9	0
I/O-box, 2nd	E9	1

## Check/Change Node ID

Step	Action
1	Remove the module according to the instruction in <a href="#">Section 2.5 Installation of internal modules, on page 76</a> .

Step	Action
------	--------

2	The Node ID of a module is set by the position of an arrow on a rotating switch at the back of the module.
---	--

Valve modules have two rotating switches, as shown in the image below:

- the first switch, labeled **A**, sets the tens and
- the second switch, labeled **B**, sets the units.

For example, to set the Node ID to **6** for a valve module, switch **A** is set to **0** and switch **B** is set to **6**.

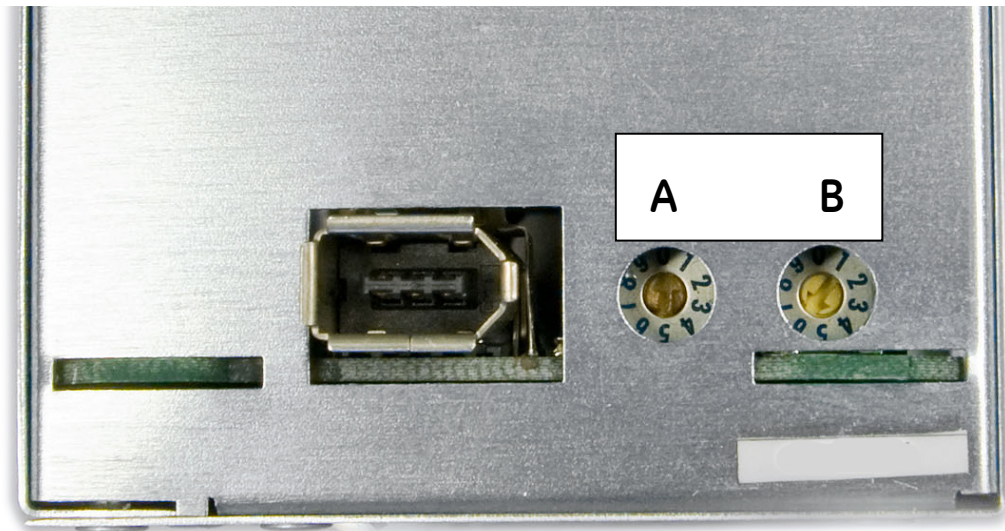

3	Check the Node ID and compare it with the listed Node IDs in the tables above.
---	--

4	To change the Node ID, use a screw driver to set the arrows of the switches to the desired number.
---	--

5	Re-install the module in the instrument, if applicable.
---	---



# 10 Ordering information

## Introduction

This chapter lists accessories and user replaceable spare parts available for ÄKTA pure.

## Mixer

Item	Code no.
Mixer chamber 0.6 ml	28956186
Mixer chamber 1.4 ml (mounted at delivery)	28956225
Mixer chamber 5 ml (included with ÄKTA pure 150)	28956246
Mixer chamber 15 ml	28980309
O-ring 13.1 × 1.6 mm <b>Note:</b> <i>For Mixer chamber 0.6, 1.4, and 5 ml.</i>	28953545
O-ring 13.1 × 1.6 mm (highly resistant) (can be used as an alternative to 28953545)	29011326
O-ring 22.1 × 1.6 mm <b>Note:</b> <i>For Mixer chamber 15 ml.</i>	28981857
Online filter kit	18102711

## Tubing

Item	Code no.
Reference capillary 1	28950749
Reference capillary 2	28950750
Tubing Kit 0.5 mm standard, ÄKTA pure 25	29011327
Tubing Kit 0.5 mm, ÄKTA pure 150	29051669
Tubing Kit 0.25 mm, ÄKTA pure 25	29011328
Tubing Kit 0.75 mm, ÄKTA pure 25	29011329
Tubing Kit 0.75 mm standard, ÄKTA pure 150	29048242

Item	Code no.
Tubing Kit 1.0 mm	29034551
Tubing kit 10×1.0 m, ETFE ID 1.0 mm OD 1/16	28980995
Tubing kit for sample inlet valve V9-IS (7-ports)	29035331
Tubing kit for sample inlet valve V9H-IS (7-ports)	29051166
Sample tubing kit for 7 inlets, i.d. 0.75 mm	28957217
Inlet tubing kit 2+2	29011330
V9-pH tubing kit	29011331
V9H-pH tubing kit standard	29051674
Tubing kit for inlet valve V9-IA (7 ports)	29011332
Tubing kit for inlet valve V9H-IA (7 ports)	29051197
Tubing kit for inlet valve V9-IB (7 ports)	29011333
Tubing kit for inlet valve V9H-IB (7 ports)	29051189
Outlet tubing kit, ÄKTA pure 25	29011334
Outlet tubing kit, ÄKTA pure 150	29048611
Rinse system tubing	29011348
Union 1/16 male/male, i.d. 0.5 mm (5-pack)	28954326
Tubing cutter	18111246
Inlet filter holder kit	11000407
Inlet filter set	11000414

## Holders

Item	Code no.
Adapter for air sensor	28956342
Bottle holder	28956327
Column clamp o.d. 10–21 mm	28956319
Column holder	28956282
Column holder rod	28956270
Flexible column holder	28956295
Loop holder	29011350

Item	Code no.
Multi-purpose holder	29011349
Rail extension	29011352
Tube holder (5-pack)	28954329
Tubing holder comb	28956286
Tubing holder spool	28956274
Inlet filter holder kit	11000407
Screw lid GL45 kit	11000410

## UV monitor

Item	Code no.
UV monitor <b>U9-L</b> (Fixed wavelength)	29011360
UV flow cell <b>U9-0.5</b> 0.5 mm for <b>U9-M</b>	28979386
UV flow cell <b>U9-2</b> 2 mm for <b>U9-M</b>	28979380
UV flow cell <b>U9-10</b> 10 mm for <b>U9-M</b>	28956378
UV flow cell 2 mm for <b>U9-L</b>	29011325
UV flow cell 5 mm for <b>U9-L</b>	18112824

## I/O box

Item	Code no.
I/O box <b>E9</b>	29011361

## Fraction collector F9-C

Item	Code no.
Fraction collector F9-C	29027743
Tubing kit for F9-C	29033632
Cassette tray	28-954209
Cassette, for deepwell plate (2-pack)	28954212
Deep well plate, 96 x 2 ml	77015200

## 10 Ordering information

Item	Code no.
Deep well plate, 48 x 5 ml	77015500
Deep well plate, 24 x 10 ml	77015102
Cassette, for 50 ml tubes (2-pack)	28956402
Cassette, for 3 ml tubes (2-pack)	28956427
Cassette, for 5 ml tubes (2-pack)	29133422
Cassette, for 8 ml tubes (2-pack)	28956425
Cassette, for 15 ml tubes (2-pack)	28956404
Rack, for 50 ml tubes	28980319
Rack, for 250 ml bottles	28981873
Cable 2.5 m, UniNet-9 D-type	29032425

## Fraction collector F9-R

Item	Code no.
Fraction collector <b>F9-R</b>	29011362
Tube Rack Complete, 175 x 12 mm	19868403
Tube Rack Complete, 95 x 10-18 mm	18305003
Tube Rack Complete, 40 x 30 mm	18112467
Bowl	18305103
Tube support	18305402
Tube holder	18646401
Tube rack upgrade kit, 175 x 12 mm	19724202
Tube rack upgrade kit, 95 x 18 mm	19868902
Tube rack upgrade kit, 40 x 30 mm	18112468
Drive sleeve	19606702

## Valves

Item	Code no.
Column valve kit <b>V9-C</b>	29011367
Column valve kit <b>V9H-C</b>	29050951
Column valve <b>V9-C2</b>	28957236
Column valve <b>V9H-C2</b>	28979330
Column valve <b>V9-Cs</b>	29011355
Column valve <b>V9H-Cs</b>	29090693
Inlet valve <b>V9-X1</b>	28957227
Inlet valve <b>V9H-X1</b>	28979326
Inlet valve <b>V9-X2</b>	28957234
Inlet valve <b>V9H-X2</b>	28979328
Inlet valve kit <b>V9-IA</b>	29012263
Inlet valve kit <b>V9H-IA</b>	29050945
Inlet valve kit <b>V9-IB</b>	29012370

Item	Code no.
Inlet valve kit <b>V9H-IB</b>	29050946
Inlet valve kit <b>V9-IAB</b>	29011357
Inlet valve kit <b>V9H-IAB</b>	29089652
Sample inlet valve kit <b>V9-IS</b>	29027746
Sample inlet valve kit <b>V9H-IS</b>	29050943
Loop valve kit <b>V9-L</b>	29011358
Loop valve kit <b>V9H-L</b>	29090689
Mixer valve kit <b>V9-M</b>	29011354
Mixer valve kit <b>V9H-M</b>	29090692
Outlet valve kit <b>V9-O</b>	29012261
Outlet valve kit <b>V9H-O</b>	29050949
Outlet valve kit <b>V9-Os</b> (1 outlet)	29011356
Outlet valve kit <b>V9H-Os</b> (1 outlet)	29090694
pH valve kit <b>V9-pH</b>	29011359
pH valve kit <b>V9H-pH</b>	29051684
Versatile valve <b>V9-V</b>	29011353
Versatile valve <b>V9H-V</b>	29090691

**Note:** All valve kits include the necessary tubing.

## Injection valve accessories

Item	Code no.
Sample loop 10 µl	18112039
Sample loop 100 µl	18111398
Sample loop 500 µl (mounted at delivery)	18111399
Sample loop 1 ml	18111401
Sample loop 2 ml	18111402
Sample loop 10 ml	18116124
Superloop 10 ml	19758501
Superloop 50 ml	18111382

Item	Code no.
Superloop 150 ml	18102385
Fill port	18112766
Injection kit	18111089
Connector 1/16" male and Luer female	28985812

## External air sensors

Item	Code no.
Air sensor L9-1.2 mm	28956502
Air sensor L9-1.5 mm	28956500

## pH monitor

Item	Code no.
pH electrode	28954215
O-ring 5.3 × 2.4 mm	28956497

## Conductivity monitor

Item	Code no.
Conductivity monitor <b>C9</b>	29011363

## Flow restrictor

Item	Code no.
Flow restrictor <b>FR-902</b>	18112135

## Module components

Item	Code no.
Module Panel	29011364
Multi-module front	29011351
Extension box	29110806

## Cables

Item	Code no.
Jumper 1 IEC 1394 (F-type)	28956489
Jumper D-SUB (D-type)	29011365
External module cable, short (F-type)	29012474
External module cable, long (F-type)	29011366
Cable 2.5 m UniNet-9 D-type	29032425

## System Pumps and Sample pump S9H

Item	Code no.
P9 Seal kit 25 ml	28952642
P9 Piston kit 25 ml	28952640
P9H Seal kit 150 ml	28979373
P9H Piston kit 150 ml	28979368
Check valve kit	28979364
Sample pump S9H	29050593

## Sample Pump S9

Item	Code no.
Sample pump S9	29027745
P9-S Seal kit	28960250
P9-S Piston kit	18111213
Check valve kit	28979364
Cable 2.5 m UniNet-9 D-type	29032425

## UNICORN

There are different UNICORN products and licenses available for different purposes, for example licenses for use with a workstation or for working remotely. Contact your local GE salesperson for more information on UNICORN products and licenses and how to order.



# Index

## A

Affinity chromatography  
predefined method, 439–440

Air sensors

air sensor adapter, 83

A test, 228

B test, 230, 232

error codes, 405

external air sensors, 87

inlet valves, 40

troubleshooting, 398

ÄKTA pure

description, 13, 86

illustrations, 14

main features, 9

maintenance, 251

overview, 9

troubleshooting, 356

Anion exchange

predefined method, 441

## C

Cabinet

troubleshooting, 396

Cassettes, 96

quickrelease function, 98

Cation exchange

predefined method, 441

Chromatofocusing

predefined method, 441

CIP

column CIP, 284

column maintenance method, 445

column predefined phase, 447

system CIP, 278

system maintenance method, 445

system predefined phase, 215, 447

Cleaning

column, 221

system, 220

Column

attach column holder, 172

cleaning, 221

column CIP, 284

column holder, 80

column valve, 55

connect column, 172

pressure alarm, 176

storage, 221

Column CIP

maintenance method, 445

predefined phase, 447

Column performance test

maintenance method, 445

predefined phase, 215, 447

Column preparation

maintenance method, 445

predefined phase, 447

Column valve

description, 55

flow paths V9-C, 56

flow paths V9-Cs, 57

V9-C test, 234

Column wash

predefined phase, 447

Component volumes, 498

Conductivity monitor

calibration, 308

clean the conductivity flow cell, 300

description, 72

error codes, 405

troubleshooting, 367

Connectors

for ÄKTA pure, 421

replace connectors, 317

## D

Delay volume

reference information, 493

settings, 207

Delta column pressure

description, 68

Desalting

predefined method, 442

Documentation, 11–12

## E

Elution

predefined phase, 447

Equilibration

predefined phase, 447

Extension box, 85

## F

Flow cells

conductivity, 72

- pH, 60
  - UV, U9-L, 70
  - UV, U9-M, 69
  - Flow path
    - component volumes, 498
    - illustration, 25, 150, 422
    - prepare, 150
    - specifications, 25
  - Flow restrictor
    - check function, 269
    - FR-902 description, 74
    - replace flow restrictor, 330
  - Fractionation
    - assemble tube rack, 105, 199
    - delay volume, 207
    - fractionation types, 206
    - prepare, 199
  - Fraction collector
    - cleaning, 267, 288, 290
    - description, 90
    - error codes F9-R, 408
    - F9-R test, 236, 239, 241
    - function, 90
    - preparation, 199
    - quickrelease function, 98
    - replace internal tubing, 319
    - specifications, 418
    - troubleshooting, 377, 385
  - Fraction collector F9-C
    - Cassettes and racks, 96
    - connect tubing, 102
    - requirements on deep well plates, 100
    - requirements on tubes, 99
    - Tubes, 105
- G**
- Gel filtration
    - predefined method, 442
- H**
- Hardware installation
    - of a module, 76
  - Holders
    - air sensor adapter, 83
    - bottle holder, 83
    - column clamp, 81
    - column holder, 80
    - column holder rod, 81
    - Extension box, 85
    - flexible column holder, 82
    - loop holder, 80
    - multi-purpose holder, 79
    - ordering information, 507
    - rail extension, 79
    - tubing holder comb, 83
    - tubing holder spool, 82
  - Hydrophobic interaction chromatography (HIC)
    - predefined method, 442
- I**
- I/O-box E9
    - connectors, 113
    - description, 112
    - error codes, 409
    - Fraction collector F9-C installation, 112
    - specifications, 419
    - troubleshooting, 399
  - Injection valve
    - description, 49
    - flow paths, 49
  - Inlet tubing
    - prepare, 152
    - prime inlet tubing B, 161
  - inlet valves
    - V9-IA test, 228
    - V9-IB test, 230, 232
  - Inlet valves
    - air sensors, 40
    - description, 39
    - inlet valve A, 39
    - inlet valve AB, 39
    - inlet valve B, 39
    - inlet valve X1, 39
    - inlet valve X2, 39
    - troubleshooting, 376
  - Installation
    - prepare waste tubing, 154
  - Instrument control panel
    - error codes, 409
    - function, 27
    - location, 27
    - status indications, 29
    - troubleshooting, 400
  - Instrument control unit
    - error codes, 404
  - Instrument overview
    - Fraction collector F9-R, 103
    - Instrument configurations, 14
    - main parts, 14
    - modules, 16
    - wet side, 15

Ion exchange  
predefined method, 441

## L

Log on  
UNICORN, 157  
Loop valve  
description, 52  
flow paths, 52

## M

Maintenance  
calibration procedures, 302  
clean the instrument, 277  
Maintenance Manager, 252  
maintenance program, 258  
maintenance when required, 276  
replacement procedures, 316  
semiannual maintenance, 272  
weekly maintenance, 261  
Maintenance manager  
handling maintenance notifications, 254  
Maintenance methods  
column CIP, 445  
column performance test, 445  
column preparation, 445  
system CIP, 445  
system preparation, 445  
Manual instructions, 465  
Manual loop fill  
predefined phase, 447  
Manual Loop Fill  
predefined method, 442  
Methods  
affinity chromatography, 439–440  
anion exchange, 441  
cation exchange, 441  
chromatofocusing, 441  
create method, 211  
desalting, 442  
gel filtration, 442  
hydrophobic interaction chromatography (HIC), 442  
maintenance methods, 211  
manual loop fill, 442  
NHS-coupling, 443  
predefined maintenance methods, 445  
predefined methods, 211, 439  
purification methods, 211

reverse phase chromatography (RPC), 444

Method settings  
predefined phase, 446

Miscellaneous  
predefined phase, 447

Mixer  
choose mixer chamber, 151  
description, 37  
error codes, 405  
mixer valve, 46  
replace mixer, 322  
replace the inline filter, 266  
replace the o-ring, 323  
specifications, 415  
troubleshooting, 395

Mixer valve  
description, 46  
flow paths, 46, 48

Module panel  
description, 84  
troubleshooting, 376

Module Panel Assembly, 124

Modules  
column valve, 55  
conductivity monitor, 72  
flow restrictor, 74  
injection valve, 49  
inlet valves, 39  
loop valve, 52  
mixer, 37  
mixer valve, 46  
outlet valve, 64  
pH valve, 60  
pressure monitor, 67  
pumps, 33, 107  
recommended positions, 124  
UV monitor, 69  
versatile valve, 59

Monitors  
conductivity, 72  
external air sensors, 87  
pH, 62  
pressure monitor, 67  
specifications, 417  
troubleshooting, 360  
UV, 69

## N

NHS-coupling  
predefined method, 443

- Node ID
  - change Node ID, 503
  - check Node ID, 503
  - description, 76
  - list, 502
- O**
- Optional configurations
  - install optional modules, 76
- Ordering information
  - cables, 512
  - conductivity monitor, 511
  - dummy module, 511
  - external air sensors, 511
  - flow restrictor, 511
  - fraction collector, 509
  - holders, 507
  - I/O-box E9, 507
  - mixer, 505
  - pH monitor, 511
  - pump, 512
  - tubing, 506
  - UV monitor, 507–508, 511
  - valves, 510
- Outlet tubing
  - prepare, 153
- Outlet valve
  - description, 64
  - V9-O ports, 64
  - V9-Os ports, 65
- P**
- Performance tests
  - air sensor A and inlet valve V9-IA, 228
  - air sensor B and inlet valve V9-IB, 230, 232
  - column valve V9-C, 234
  - fraction collector F9-R, 236, 239, 241
  - overview, 225
  - UV U9-L system, 243
  - UV U9-M system, 247
- Phases
  - column CIP, 447
  - column performance test, 215, 447
  - column preparation, 447
  - column wash, 447
  - elution, 447
  - equilibration, 447
  - manual loop fill, 447
  - method settings, 446
  - miscellaneous, 447
  - predefined phases, 446
  - sample application, 447
  - system CIP, 215, 447
  - system preparation, 447
- pH monitor
  - calibration, 303
  - clean the pH electrode, 293
  - description, 62
  - error codes, 405
  - replace the pH electrode, 275
  - storage of the pH electrode, 221, 291
  - troubleshooting, 370
- pH valve
  - description, 60
  - flow paths, 61
  - troubleshooting, 370, 376
- Power and ICU
  - troubleshooting, 396
- Power save, 146
- Prepare the system
  - connect column, 172
  - flow path, 150
  - fraction collector, 199
  - inlet tubing, 152
  - mixer, 151
  - outlet tubing, 153
  - sample application, 179
  - Start UNICORN, 157
  - UV monitor U9-L, 152
  - UV monitor U9-M, 152
  - waste tubing, 154
- Pressure alarm
  - set, 176
- Pressure control
  - system configuration, 219
- Pressure monitor
  - error codes, 404
- Pressure monitors
  - calibration, 305
  - check the pressure monitors, 305
  - description, 67
  - troubleshooting, 372
- Prime inlet tubing B, 161
- Process picture
  - actions in the process picture, 219
- Pump piston rinsing system
  - flow path, 35
  - illustration, 35, 109, 262, 264, 352–353
  - prime, 263, 265
- Pumps
  - change pump rinsing solution, 262
  - clean check valves, 296

- description, 33
- description, sample pump, 107
- error codes, 406
- purge sample pump, 167
- purge system pumps, 161
- replace check valves, 332
- replace pump pistons, 351
- replace pump piston seals of pump P9, 335
- replace pump piston seals of Pump P9-S, 344
- replace pump rinsing system tubing, 352
- specifications, 413
- troubleshooting, 387

## Q

- QuickRelease function, 98

## R

- reference information
  - injection volumes and peak broadening, 492
- Reference information, 410
  - back pressure, 501
  - chemical resistance guide, 431
  - delay volumes, 493
  - module specifications, 413
  - pressure regulation, 500
  - system specifications, 411
- Reverse phase chromatography (RPC)
  - predefined method, 444
- Run
  - after run procedures, 220
  - available curves, 490
  - available run data, 487
  - choose method, 216
  - monitor run, 218
  - perform manual run, 217
  - perform run, 216
  - prepare run, 216

## S

- Safety notices, 7
- Sample application
  - flow paths, 49
  - injection valve, 49
  - predefined phase, 447
  - sample loading, 179
  - sample loop, 189
  - superloop, 182
- Sample loop

- sample loading, 189
- Sample pump
  - description, 107
- Software overview
  - software modules, 9
- Storage
  - column, 221
  - pH electrode, 221
  - system, 221
- Superloop
  - sample loading, 182
  - troubleshooting, 396
- System CIP
  - maintenance method, 445
  - predefined phase, 215, 447
- System cleaning, 220
- System configuration
  - control pressure, 219
  - installation of modules, 76
  - modules and positions, 124
  - overview, 124
  - system properties, 127
  - system settings, 129
- System Control module
  - manual instructions, 465
- System preparation
  - before preparation, 149
  - maintenance method, 445
  - predefined phase, 447
- System pumps
  - operating ranges, 33
- System storage, 221
- System test
  - UV U9-L, 243
  - UV U9-M, 247

## T

- Technical specifications
  - module specifications, 413
- Trays, 96
- Troubleshooting
  - error codes, 404
  - fraction collector, 377
  - Fraction collector, 385
  - instrument communication, 401
  - monitors, 360
  - other components, 394
  - pumps, 387
- Tube rack
  - assembly, 105, 199
- Tubing

- for ÄKTA pure, 420
- replace tubing, 317, 319

## U

### UNICORN

- connect to system, 158
- Log on, 157
- Start, 157

- User information, 7

- UV detector U9-D
  - error codes, 406

- UV monitor
  - calibration, 152, 312
  - clean UV flow cell, 273
  - description, 69
  - installing two monitors, 139
  - replace UV flow cell, 325, 328

- UV monitor U9-L
  - description, 70, 152
  - error codes, 407
  - replace the flow cell, 328
  - system test, 243
  - troubleshooting, 364

- UV monitor U9-M
  - description, 69, 152

- error codes, 406
- system test, 247
- troubleshooting, 360

## V

### Valves

- column valve, 55
- error codes, 404
- extra Column valve, 56
- extra inlet valves, 39
- injection valve, 49
- inlet valves, 39
- loop valve, 52
- mixer valve, 46
- outlet valve, 64
- overview, 38
- pH valve, 60
- specifications, 414
- versatile valve, 59

- Versatile valve
  - description, 59
  - flow paths, 59

## W

- Waste tubing, 154
  - prepare, 154

For local office contact information, visit  
[www.gelifesciences.com/contact](http://www.gelifesciences.com/contact)

GE Healthcare Bio-Sciences AB  
Björkgatan 30  
751 84 Uppsala  
Sweden

[www.gelifesciences.com/AKTA](http://www.gelifesciences.com/AKTA)

GE, the GE Monogram, ÄKTA, AxiChrom, GSTrap, HiLoad, HiPrep, HiScreen, HiTrap, HisTrap, Mini Q, Mini S, Mono Q, Mono S, Mono P, RESOURCE, Sephacryl, Sepharose, SOURCE, StrepTrap, Superdex, Superloop, Superose, UNICORN, and Whatman are trademarks of General Electric Company.

Decon is a trademark of Decon Laboratories, Limited. Elgiloy is a trademark of Elgiloy Limited Partnership. Eppendorf is a trademark of Eppendorf AG. Hastelloy is a trademark of Haynes International Inc. Kautex is a trademark of Kautex Textron GmbH & Co. KG. Microsoft and Windows are registered trademarks of Microsoft Corporation. Nalgene is a trademark of Nalge Nunc International Corporation. NUNC is a trademark of Thermo Fisher Scientific LLC. Seahorse Bioscience is a trademark of Seahorse Bioscience Corporation. Tween is a trademark of Uniqema Americas LLC. VWR is a trademark of VWR International, Inc.

All other third party trademarks are the property of their respective owners.

Any use of UNICORN is subject to GE Healthcare Standard Software End-User License Agreement for Life Sciences Software Products. A copy of this Standard Software End-User License Agreement is available on request.

© 2012-2018 General Electric Company

All goods and services are sold subject to the terms and conditions of sale of the company within GE Healthcare which supplies them. A copy of these terms and conditions is available on request. Contact your local GE Healthcare representative for the most current information.

GE Healthcare Europe GmbH  
Munzinger Strasse 5, D-79111 Freiburg, Germany

GE Healthcare UK Limited  
Amersham Place, Little Chalfont, Buckinghamshire, HP7 9NA, UK

GE Healthcare Bio-Sciences Corp.  
100 Results Way, Marlborough, MA 01752, USA

HyClone Laboratories, Inc.  
925 W 1800 S, Logan, UT 84321, USA

GE Healthcare Japan Corporation  
Sanken Bldg. 3-25-1, Hyakunincho Shinjuku-ku, Tokyo 169-0073, Japan

