

Register your instrument!  
[www.eppendorf.com/myeppendorf](http://www.eppendorf.com/myeppendorf)



# Innova<sup>®</sup> S44i

Operating Manual

Copyright © 2022 Eppendorf SE, Germany. All rights reserved, including graphics and images. No part of this publication may be reproduced without the prior permission of the copyright owner.

Eppendorf® and the Eppendorf Brand Design are registered trademarks of Eppendorf SE, Germany.

Innova® is a registered trademark of Eppendorf, Inc., USA.

VisioNize® is a registered trademark of Eppendorf SE, Germany.

Registered trademarks and protected trademarks are not marked in all cases with ® or ™ in this manual.

The software included in this product contains copyrighted software that is licensed under the GPL. A copy of that license is included in the settings of the device. You may obtain the complete corresponding source code from us for a period of three years after our last shipment of this product. Please direct your request to [eppendorf@eppendorf.com](mailto:eppendorf@eppendorf.com).

Protected by U.S. Patent No. US 8,226,291.

## Table of contents

<b>1</b>	<b>Operating instructions</b>	<b>7</b>
1.1	Using this manual	7
1.2	Danger symbols and danger levels	7
1.2.1	Danger symbols	7
1.2.2	Danger levels	7
1.3	Symbols used	8
1.4	Abbreviations used	8
1.5	Glossary	8
<b>2</b>	<b>Safety</b>	<b>9</b>
2.1	Intended use	9
2.2	Warnings for intended use	9
2.3	Application limits	11
2.4	User profile	12
2.5	Personal protective equipment	12
2.6	Warning signs on the device	12
<b>3</b>	<b>Product description</b>	<b>13</b>
3.1	Product overview	13
3.1.1	Front view	13
3.1.2	Back view	14
3.2	Delivery package	15
3.3	Features	15
3.4	Intuitive operating concept	16
3.5	Connectivity	16
<b>4</b>	<b>Installation</b>	<b>17</b>
4.1	Selecting the location	17
4.2	Installing the interchangeable platform	19
4.3	Installing flask clamps	22
4.4	Making connections	23
4.4.1	Electrical connection	23
4.4.2	Drain connection	24
4.5	Connecting to VisioNize Lab Suite	24
4.5.1	Registration to VisioNize Lab Suite	26
<b>5</b>	<b>Operation</b>	<b>27</b>
5.1	Opening the door	27
5.2	Loading the device	27
5.3	Switching the device on/off	28
5.4	Automatic restart after power failure	28
<b>6</b>	<b>Operating control overview</b>	<b>29</b>
6.1	Operating the user interface	29
6.2	Symbols	29
6.3	Home screen overview	31
6.3.1	Home screen	31
6.3.2	Function area	32

**Table of contents**

Innova® S44i  
English (EN)

6.3.3	Toolbar	33
6.3.3	Toolbar	33
6.3.4	Status bar/information bar	33
6.3.4	Status bar/information bar	33
6.4	Function control	34
6.4.1	Selecting the function	34
6.4.2	Setting the set value	34
6.4.2	Setting the set value	34
6.4.3	Switching between functions	36
<b>7</b>	<b>Starting the application</b>	<b>37</b>
7.1	Starting and stopping the device	37
7.2	Setting the temperature value	37
7.3	Setting the speed value	38
7.4	Setting the speed timer	39
7.5	Setting the photosynthetic light	40
<b>8</b>	<b>The Menu area</b>	<b>41</b>
8.1	Settings	42
8.1.1	The About this Innova S44i menu item	42
8.1.2	The System Settings menu item	43
8.1.3	The Device Settings menu item	48
8.1.4	Balance Master function	51
8.2	Events	58
8.2.1	Filtering Events	59
8.2.2	Editing Events	59
8.2.3	Exporting Events	59
8.3	Alarms	59
8.3.1	Setting alarms and alarm limits	60
8.3.2	Active alarm	62
8.3.3	Setting the door alarm	62
8.3.4	Setting the speed alarm	63
8.3.5	Setting the temperature alarm	63
8.4	Contact and Support	64
8.5	Charts	65
8.5.1	Selecting functions	66
8.5.2	Selecting the time span	67
8.5.3	Displaying the chart's measured values	67
8.5.4	Exporting charts	67
8.6	Clean Screen	68
8.7	Export	68
8.8	Programs	70
8.8.1	Adding programs	72
8.8.2	Editing programs	72
8.8.3	Deleting or duplicating programs	73
8.9	Login	74
8.9.1	Logging in and out as a user	74

<b>9</b>	<b>User administration</b>	<b>75</b>
9.1	The user administration concept	75
9.1.1	User roles for working with the user administration	75
9.1.2	Working without user administration	75
9.1.3	User rights	76
9.2	Defining settings in the user administration	79
9.2.1	Creating an administrator	79
9.2.2	Editing the user administration	80
9.2.3	Deactivating the user administration	81
9.3	Editing user accounts as an administrator	82
9.3.1	Creating a user account	82
9.3.2	Editing user accounts	83
9.3.3	Deleting a user account	84
9.3.4	Resetting the password/PIN for a user account	85
9.4	Administrating your own user account	86
<b>10</b>	<b>Maintenance</b>	<b>87</b>
10.1	Service options	87
10.2	Cleaning/decontamination	87
10.2.1	Routine cleaning	88
10.2.2	Wipe decontamination	88
10.2.3	Wipe decontamination of the touch screen	89
10.2.4	Decontamination of the chamber bottom cover after spills	89
10.3	Service intervals	90
<b>11</b>	<b>Troubleshooting</b>	<b>91</b>
<b>12</b>	<b>Transport, storage and disposal</b>	<b>93</b>
12.1	Transport	93
12.2	Shipping the device	93
12.3	Storage	94
12.4	Disposal	94
<b>13</b>	<b>Technical data</b>	<b>95</b>
13.1	Power supply	95
13.2	Ambient conditions	95
13.3	Noise level	95
13.4	Weight/dimensions	96
13.4.1	Device	96
13.4.2	Base	96
13.4.3	Platform	96
13.5	Material	97
13.6	Stacking dimensions	97
13.7	Interfaces	98
13.8	Application parameters	98
13.8.1	Agitation	98
13.8.2	Load	98
13.8.3	Temperature	98
13.8.4	Photosynthetic light	99

**Table of contents**Innova® S44i  
English (EN)

13.9 Counterweight.....	99
13.9.1 Counterweight settings for Balance Master calibration.....	99
13.9.2 Optimal counterweight settings.....	100
<b>14 Ordering Information.....</b>	<b>103</b>
14.1 Devices.....	103
14.2 Accessories.....	104
14.3 Spare parts.....	106
14.4 Connectivity.....	106
<b>Index.....</b>	<b>107</b>
<b>Certificates.....</b>	<b>109</b>

# 1 Operating instructions









## 1.1 Using this manual

- ▶ Read this operating manual thoroughly before using the device for the first time. Also observe the instructions for use of the accessories.
- ▶ This operating manual is part of the product. It must always be kept easily accessible.
- ▶ Enclose this operating manual when transferring the device to third parties.
- ▶ You will find the current version of the operating manual for all available languages on our website at [www.eppendorf.com/manuals](http://www.eppendorf.com/manuals).

## 1.2 Danger symbols and danger levels

### 1.2.1 Danger symbols

The safety instructions in this manual appear with the following danger symbols and danger levels:

	<b>Hazard point</b>		<b>Danger of cuts</b>
	<b>Electric shock</b>		<b>Heavy load</b>
	<b>Toxic</b>		<b>Risk of crushing</b>
	<b>Biohazard</b>		<b>Material damage</b>
	<b>Hot surface</b>		

### 1.2.2 Danger levels

<b>DANGER</b>	<i>Will</i> lead to severe injuries or death.
<b>WARNING</b>	<i>May</i> lead to severe injuries or death.
<b>CAUTION</b>	May lead to light to moderate injuries.
<b>NOTICE</b>	May lead to material damage.

### 1.3 Symbols used

Depiction	Meaning
1. 2.	Actions in the specified order
▶	Actions without a specified order
•	List
<i>Text</i>	Display or software texts
<b>i</b>	Additional information

### 1.4 Abbreviations used

**rpm**

Revolutions per minute

### 1.5 Glossary

**VisioNize touch enabled device:** Device from Eppendorf, which comes with the VisioNize touch interface. VisioNize touch enabled devices are able to connect with the web application *VisioNize Lab Suite*, when connected to the Internet.

**VisioNize Lab Suite:** *VisioNize Lab Suite* is a cloud-based platform where customers can access services that can be tailored to their specific needs. The *VisioNize Lab Suite* is designed as a provider-independent solution and works with different degrees of connectivity from Eppendorf devices to devices from third-party suppliers.

**VisioNize Services:** Applications for data management, notification by e-mail/SMS, remote monitoring, maintenance planning, and for accessing device-related documents of connected and non-connected devices. Use of *VisioNize Lab Suite* and Services requires purchase of additional subscription. For more information: <https://www.eppendorf.com/visionize>



## 2 Safety

### 2.1 Intended use

Innova S44i biological shakers are designed for temperature control and shaking of liquids in flasks, tubes or plates to support the cultivation of bacterial, insect, fungal, yeast and phototrophic organisms. The shaker is intended for research use only. Innova S44i biological shakers are intended for indoor laboratory use.

### 2.2 Warnings for intended use

---



**WARNING! Lethal voltages inside the device.**

Touching high-voltage parts can cause an electric shock. Electric shocks can cause heart injury and respiratory paralysis.

- ▶ Ensure that the housing is closed and undamaged.
- ▶ Do not remove the housing.
- ▶ Make sure that no liquids enter the device.

Only authorized service staff may open the device.



**WARNING! Danger due to incorrect voltage supply.**

- ▶ Only connect the device to voltage sources which correspond with the electrical requirements specified on the name plate.
- ▶ Only use earth/grounded sockets with a protective earth conductor.
- ▶ Only use the mains/power cord supplied.



**WARNING! Electric shock due to damage to the device or the mains/power cord.**

- ▶ Only switch on the device if the device and the mains/power cord are undamaged.
- ▶ Only operate devices which have been installed or repaired properly.
- ▶ In the event of danger, disconnect the device from the mains/power supply voltage. Disconnect the mains/power plug from the device or the earth/grounded socket. Use the isolating device intended for this purpose (e.g., the emergency switch in the laboratory).



**WARNING! Damage to health due to infectious liquids and pathogenic germs.**

- ▶ When handling infectious liquids and pathogenic germs, observe the national regulations, the biosafety level of your laboratory, the Safety Data Sheets, and the manufacturer's application notes.
- ▶ Wear your personal protective equipment.
- ▶ Consult the "Laboratory Biosafety Manual" (source: World Health Organization, Laboratory Biosafety Manual, in its respectively current valid version).

**WARNING! Damage to health due to toxic, radioactive or aggressive chemicals.**

- ▶ Wear your personal protective equipment.
- ▶ Observe the national regulations for handling these substances.
- ▶ Observe the manufacturer's Safety Data Sheets and application notes.

**WARNING! Risk of crushing fingers with door**

- ▶ Do not reach between the door and device, or into the door locking mechanism when opening and closing the door.

**WARNING! Burns due to hot metal on the device and hot flasks**

- ▶ Only touch the device and flasks when wearing protective gloves.

**CAUTION! Cutting injuries caused by glass shards.**

A damaged touch screen can lead to cuts on the hands.

- ▶ Only work with the touch screen if it is not damaged.

**CAUTION! Poor safety due to incorrect accessories and spare parts.**

The use of accessories and spare parts other than those recommended by Eppendorf may impair the safety, functioning and precision of the device. Eppendorf cannot be held liable or accept any liability for damage resulting from the use of accessories and spare parts other than those recommended or from improper use.

- ▶ Only use accessories and original spare parts recommended by Eppendorf.

**NOTICE! Damage to electronic components due to condensation.**

Condensate may form in the device when it has been transported from a cool environment to a warmer environment.

- ▶ After installing the device, wait for at least 6 h. Only then connect the device to the mains/power line.

**NOTICE! Damage to device or malfunctions due to a damaged touch screen.**

- ▶ Do not operate the device.
- ▶ Switch off the device, disconnect the mains/power plug and have the touch screen replaced by a service technician who has been authorized by Eppendorf.



**NOTICE! Damage to device from unsuitable cleaning agents or sharp or pointed objects.**

Use of unsuitable cleaning agents may damage the device.

- ▶ Do not use corrosive cleaning agents, strong solvents or abrasive polishes.
- ▶ Check the compatibility with the materials used.
- ▶ Please note the information on chemical resistance.
- ▶ Do **not** clean the device with acetone or organic solvents with a similar effect.
- ▶ Do **not** use sharp or pointed objects to clean the device.



**NOTICE! Damage due to aggressive chemicals.**

- ▶ Do not use any aggressive chemicals on the device or its accessories, such as strong and weak bases, strong acids, acetone, formaldehyde, halogenated hydrocarbons or phenol.
- ▶ If the device has been contaminated by aggressive chemicals, clean it immediately using a mild cleaning agent.



**NOTICE! Material damage due to device vibration**

If you place objects on the device, they may fall off due to vibration.

- ▶ Do not place any objects on the device.

---

## 2.3 Application limits



**DANGER! Risk of explosion.**

- ▶ Do not use the device in an explosive atmosphere.
- ▶ Do not operate the device in areas where work with explosive substances is carried out.
- ▶ Do not use the device to process any explosive or highly reactive substances.
- ▶ Do not use the device to process any substances which could generate an explosive atmosphere.

---

Due to its design and the ambient conditions in its interior, the device is not suitable for use in potentially explosive atmospheres.

The device may only be used in a safe environment, e.g., the open atmosphere of a ventilated lab. The use of substances which may contribute to a potentially explosive atmosphere is not permitted. The final decision on risks associated with the use of such substances lies with the user.

## 2.4 User profile

The device and accessories may only be operated by trained and skilled personnel.



Before using the device, read the operating manual and the instructions for use of the accessories carefully and familiarize yourself with the device's mode of operation.

## 2.5 Personal protective equipment

Personal protective equipment protects your life and your health.

- ▶ Always wear the personal protective equipment required for the biosafety level and by the laboratory regulations.
- ▶ Always wear protective clothing, protective gloves, and safety boots.
- ▶ If additional protective equipment is required, this is indicated above the respective instruction.

## 2.6 Warning signs on the device

Representation	Meaning	Location
	Hazard point! Risk of injury from moving parts	On door handle
	Risk of burns from hot surface	Handle of sub-platform
	Risk of crushing from moving parts	Bottom front, bottom left and bottom right side in the chamber

### 3 Product description

#### 3.1 Product overview

##### 3.1.1 Front view

The configuration of your Innova S44i depends on your order.

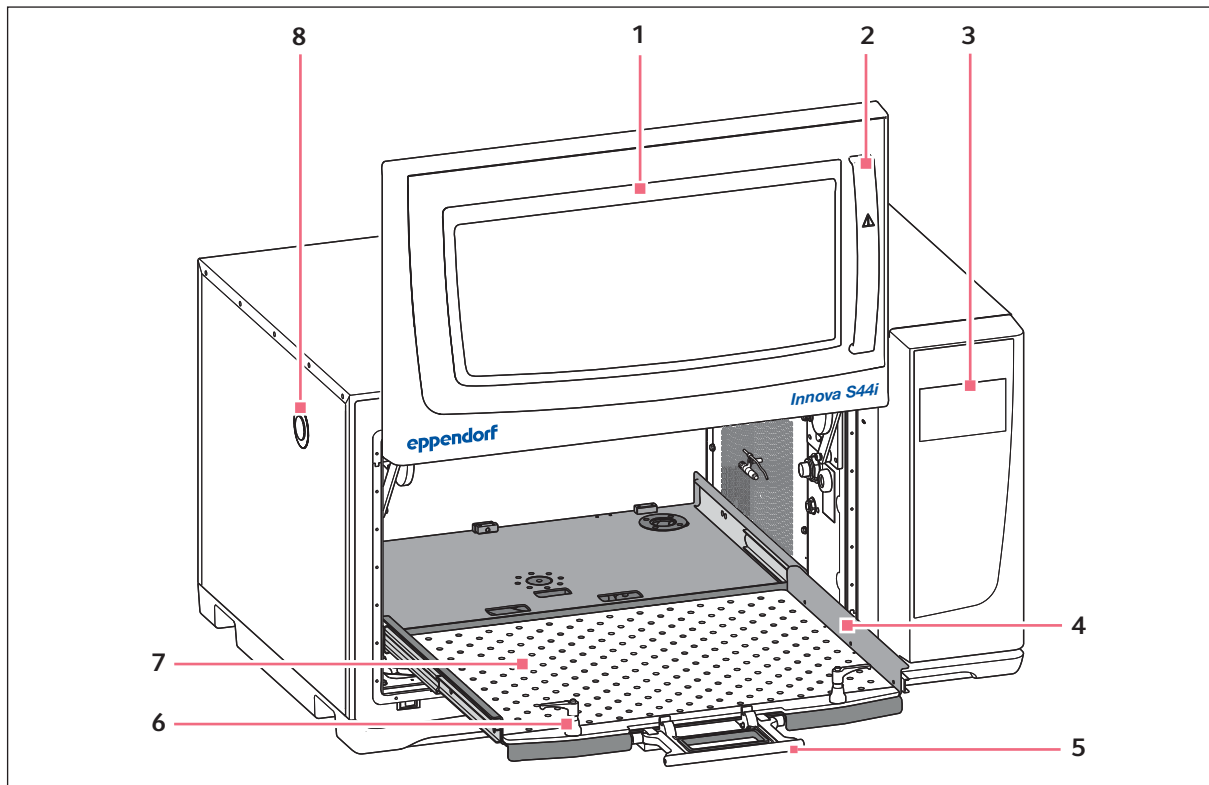

Fig. 3-1: Front view

#### 1 Door

The door has a large viewing window

#### 2 Door handle

#### 3 Touch screen

Display of user-defined parameters and actual values

#### 4 Sub-platform

#### 5 Sub-platform handle

#### 6 Platform fastener

Two platform fasteners attach the interchangeable platform to the sub-platform

#### 7 Interchangeable platform

#### 8 Access port

Pass-through for external cables and equipment (25 mm)

**Product description**

Innova® S44i  
English (EN)

**3.1.2 Back view**

Fig. 3-2: Back view with interfaces

**1 Mains/power cord socket**

**2 USB port**

**3 Ethernet port**

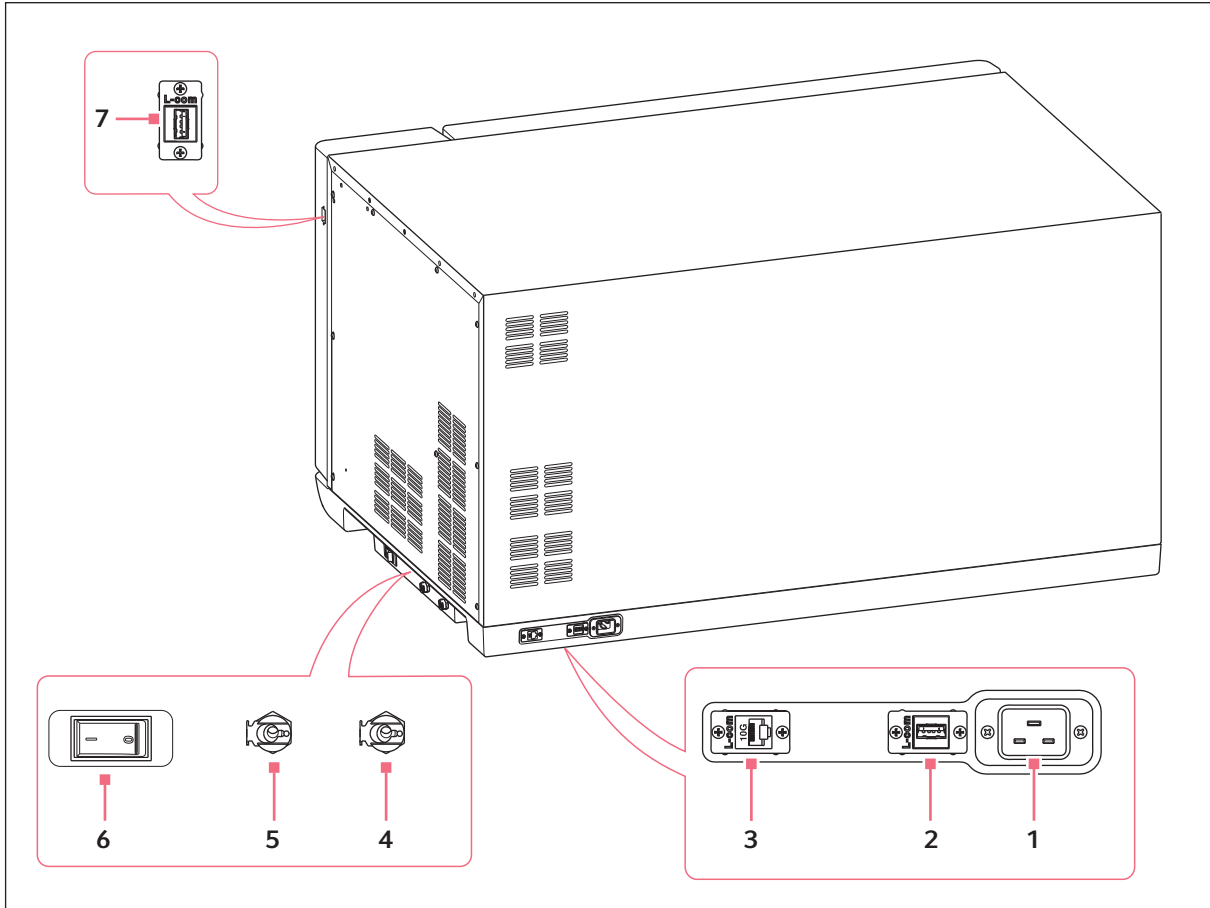
**4 Refrigeration drain**

Drain for condensation water

**5 Base drain**

For service purpose only

**6 Mains/power switch**

**7 USB port**

Only devices which meet the prerequisites of the EN IEC 62368-1 (UL 62368-1) standards may be connected to the interfaces.

## 3.2 Delivery package

Quantity	Description
1	Innova S44i, according to order
1	Mains/power cord, country specific
2	Drain tubing, inner diameter 6.35 mm (1/4 in), outer diameter 9.52 mm (3/8 in)
1	Operating manual
1	Certificate of Quality
1	Socket for pallet disassembly



- ▶ Check that the delivery is complete.
- ▶ Check all parts for transport damage.
- ▶ To safely transport and store the device, retain the transport box and packing material.

## 3.3 Features

The Innova S44i is a large-capacity, stackable shaker with a temperature control function. Its innovative drive with counterbalance adjustment is engineered to support smooth shaking of uneven and heavy loads at high speeds. Designed to provide maximum capacity with a compact footprint, the shaker may also be double-stacked or triple-stacked to further expand platform capacity.

The shaker is available with 2 different orbit sizes, refrigerated and non refrigerated, and with optional photosynthetic LED lights. It supports various applications, including the culturing of bacterial, fungal, yeast, insect, and phototrophic organisms.

Use of the shaker is facilitated by:

- Automated imbalance detection and speed reduction
- Software-guided counterweight adjustment
- Space-saving glide-up door
- Sub-platform with quick-release handle
- Large, easy-to-read touch screen display
- Integrated data logging function
- Data export via USB port

The Innova S44i can be operated in the following ways:

- Continuously: at a set speed
- In a timed mode: run at a set speed for a period of up to 95:59 hours, after which the shaker stops agitation
- In a programmed mode: allows user-defined multiple step programming of parameters, including the option to run cycle programs

The Innova S44i is a highly versatile shaker with multiple platforms and accessories to customize the shaker for different applications and user needs. An extensive selection of tubes, plates, and Erlenmeyer flasks up to 5 L can be used in the chamber. An optional perforated incubation shelf may be added to incubate static cultures.

**Product description**

Innova® S44i  
English (EN)

### 3.4 Intuitive operating concept

Eppendorf offers a cross-product operating concept which supports swift familiarization with different Eppendorf products. For different Eppendorf products, the basic operating controls are compatible with each other by using an intuitive touch user interface.

### 3.5 Connectivity

The device can be integrated into the digital solution of Eppendorf: VisioNize Lab Suite.

VisioNize Lab Suite is a cloud-based platform intended to be used for:

- connecting internet-enabled laboratory devices for data management, notification services by e-mail/SMS, remote monitoring, maintenance planning, and accessing device-related documents
- manually managing laboratory devices for data management, maintenance planning, and accessing device-related documentation

Learn more about VisioNize Lab Suite by visiting [www.eppendorf.com/visionize](http://www.eppendorf.com/visionize).

Accessories are required for connecting to VisioNize Lab Suite (see p. 106).



## 4 Installation

### 4.1 Selecting the location

---



**WARNING! Risk of injury due to unsuitable work surface.**

The device may fall down if placed on an unsuitable work surface.

- ▶ Observe the criteria for selecting a location. The criteria can be found in the operating manual.
- 



**NOTICE! Damage due to overheating.**

- ▶ Do not place the device close to sources of heat (e.g., radiator, drying cabinet).
  - ▶ Do not expose the device to direct sunlight.
  - ▶ Ensure that all sides of the device are an adequate distance from the wall and adjacent devices to guarantee unobstructed air circulation.
-

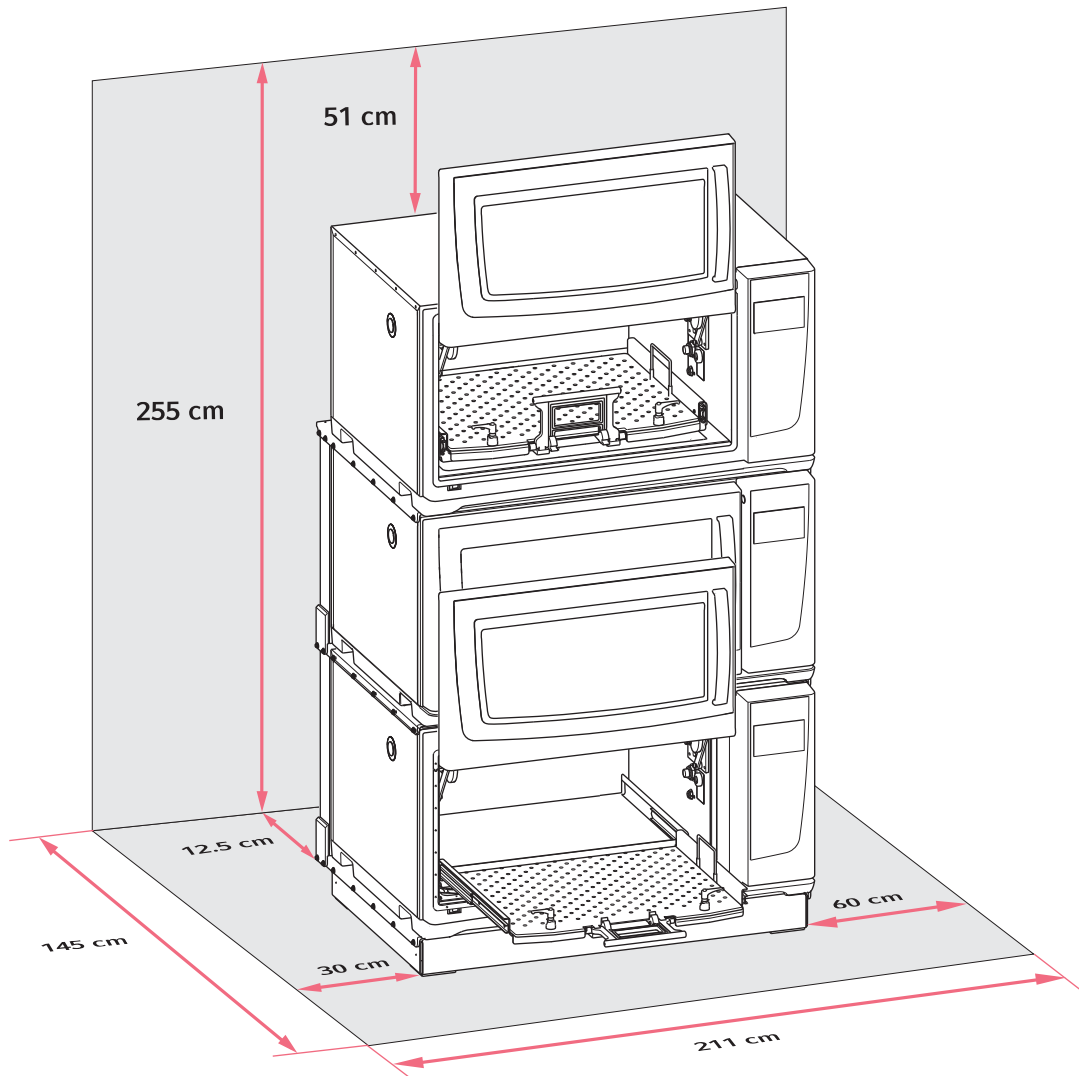

Fig. 4-1: Space requirements for the Innova S44i

For information on ambient conditions, device dimensions, and weights, see the Technical Data chapter (see p. 95).

#### Location in general

- A space of at least 12.5 cm (5 in) on the back side of the device is required for proper ventilation and access to the mains/power cord socket.
- Total space requirement in depth: 145 cm (57 in), measured from the wall to the extended platform
- A space of 30 cm (12 in) on the left-hand side of the device is required for access to the access port.
- A space of 60 cm (24 in) on the right-hand side of the device is required for service access.
- The ambient conditions match the specifications in the technical data.
- The device can be safely and easily operated at this location.

- If you want to drain the condensation water from devices with refrigeration via a house water drain, select a location with a readily accessible house water drain.
- The location is protected from direct sunlight.
- The ceiling is high enough to open the shaker glide-up door.

#### Electrical connections

- Verify that your mains/power connection matches that specified on the name plate
- Ensure there is enough room to access the mains/power switch and mains/power plug.

## 4.2 Installing the interchangeable platform

Prior to use, an interchangeable platform must be installed on the device.



When you set up a device for the first time, start a Balance Master calibration before installing the interchangeable platform (see *Calibrating the Balance Master function* on p. 52).

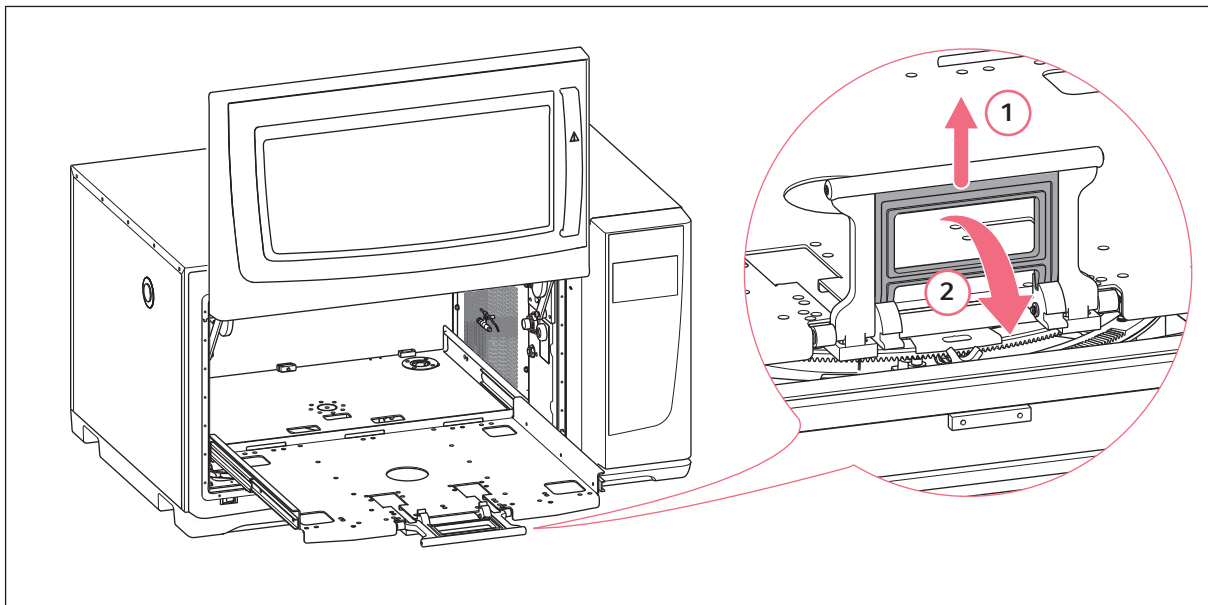

Fig. 4-2: Disengaging the sub-platform

1. Open the shaker door.
2. To disengage the sub-platform locking mechanism, squeeze the sub-platform handle (1) and rotate it down (2).



Apply light pressure towards the inside of the chamber to disengage the handle more easily.

3. To slide out the sub-platform, pull the handle.

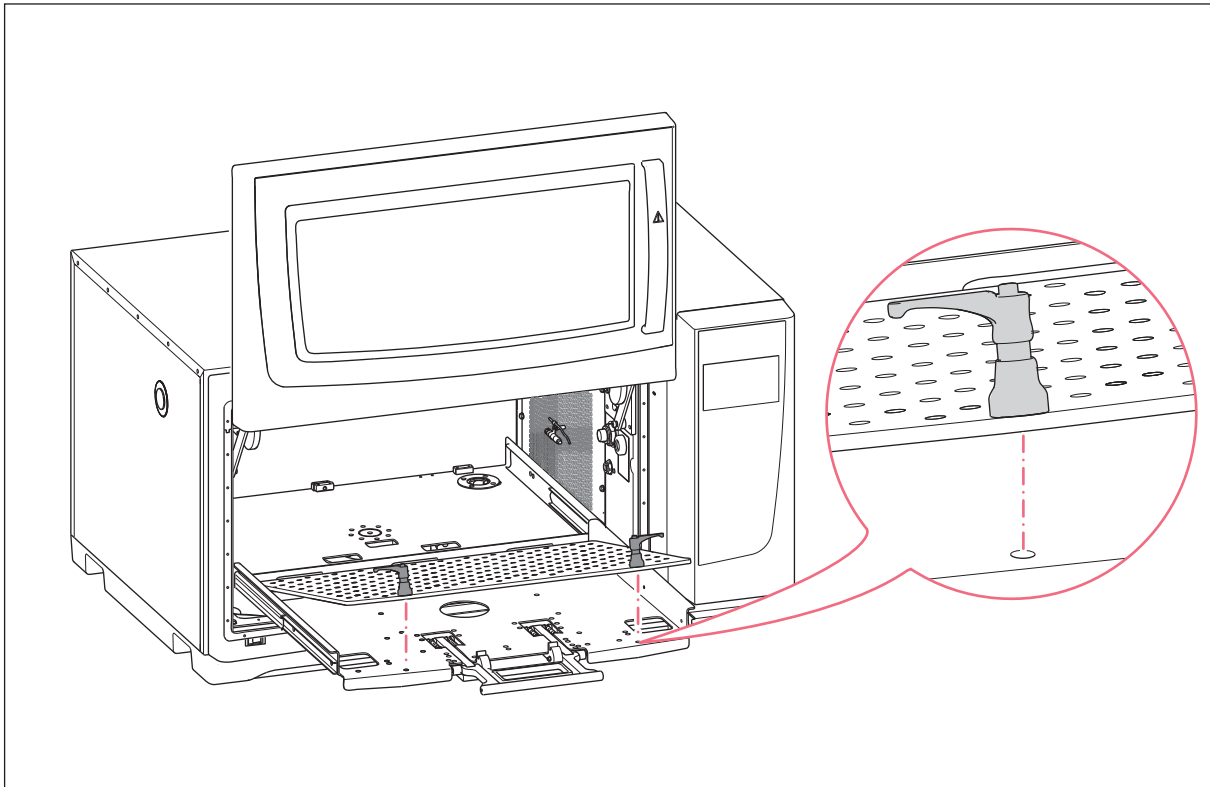

Fig. 4-3: Installing the interchangeable platform

- Place the interchangeable platform on the sub-platform. Make sure that the platform fastener screw pins are aligned to the holes of the sub-platform.



To locate the mounting holes more easily, push down the platform fasteners with both hands when the interchangeable platform is in the locked position.

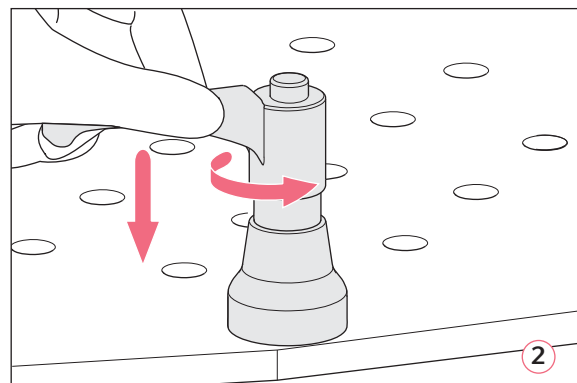
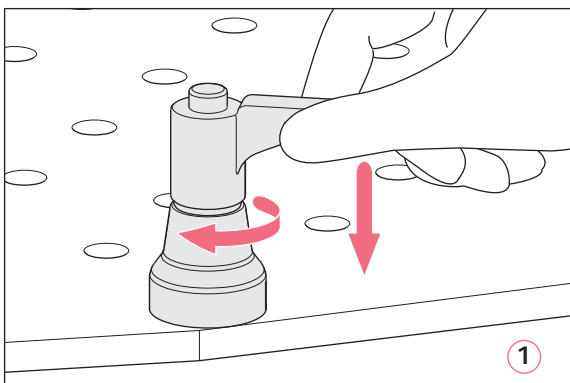

Fig. 4-4: Fastening the interchangeable platform (1); loosening the interchangeable platform (2)

- To fasten the interchangeable platform, press down the platform fastener handle and turn it clockwise (1).

If you are unable to turn the handle in full rotation due to the platform load, lift the platform fastener handle and turn it counterclockwise. To fasten the interchangeable platform, press down the handle and turn it clockwise again. Repeat the process several times.

6. To fully attach the interchangeable platform, repeat this process with the other platform fastener. Make sure that the interchangeable platform sits tight and secure.
7. Align the platform fastener handles sideways, so that they do not interfere with the application. To align the handle properly, lift and turn the handle.
8. Push the sub-platform back into the device.
9. Squeeze and rotate the sub-platform handle up. Make sure that the sub-platform handle is fully engaged and in the locked position.

#### **Uninstalling the interchangeable platform**

1. To loosen the interchangeable platform from the sub-platform, press down the platform fastener handle and turn it counterclockwise (2).
2. Remove the interchangeable platform from the device.

### 4.3 Installing flask clamps



**NOTICE! Material damage due to incorrect accessories**

If the screws are too long, they may affect the stability and functionality of the interchangeable platform.

- ▶ Make sure that only the provided screws are used to secure the flask clamps.

#### Auxiliary equipment

- Phillips screwdriver
- Flat Phillips head screws, provided

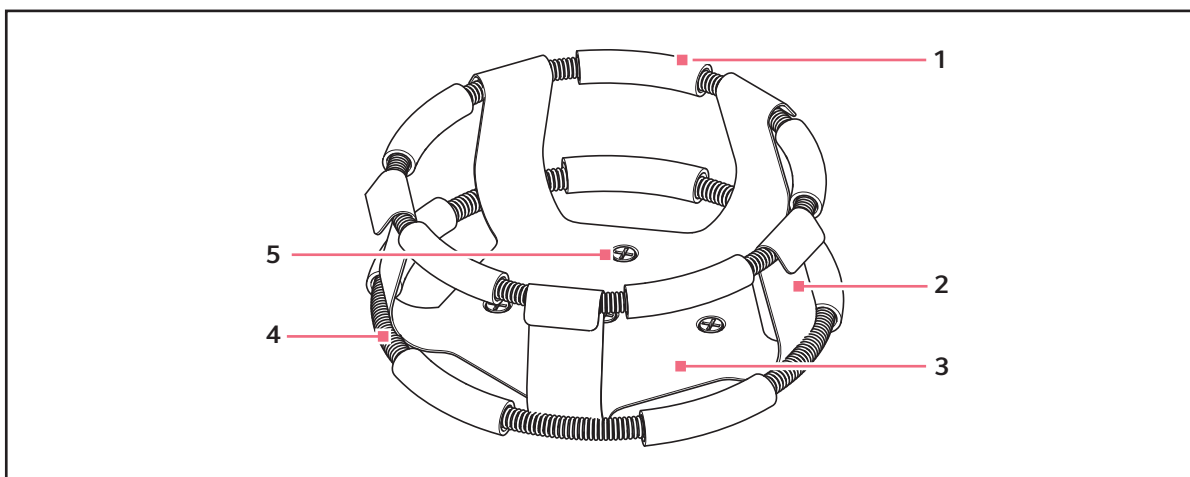

Fig. 4-5: Flask clamp with double girdle

- 1 Girdle tube
- 2 Clamp finger
- 3 Clamp body

- 4 Girdle
- 5 Clamp mounting hole



The upper girdle secures the flask within the clamp, and the bottom girdle keeps the flask from spinning.

Flask clamps for 2 L, 2.8 L, 4 L and 6 L Erlenmeyer flasks are provided with an additional girdle to help keep the flasks in place. One girdle is already in place on the clamp, the other is packed separately.

Flask clamps purchased for use with the universal platform require installation.

To secure the clamp to the interchangeable platform, proceed as follows:

1. Place the clamp on the platform, aligning its mounting holes with the holes on the platform.
2. Secure the clamp in place using the provided flat Phillips head screws.
3. For clamps with an additional girdle: Insert an empty flask into the clamp. Keep the first girdle in place on the upper part of the clamp body.
4. Make sure the girdle tubes are located between the clamp fingers and roll the first girdle down the clamp fingers as far as it can go.

The girdle tubes will rest against the platform, and the springs will be under the clamp base.

5. Place the second girdle around the upper part of the clamp, just as the first girdle was initially. Make sure that its spring sections rest against the clamp fingers, while its girdle tubes sit between the clamp fingers to hold the flask.

Flask clamps and other accessories can be interchangeably used on a variety of Eppendorf platforms. Flat head screws of different lengths and pitches are provided with the accessory.



Ensure the use of the proper screw with the proper platform and accessory configuration.

## 4.4 Making connections

### 4.4.1 Electrical connection



#### **WARNING! Danger due to incorrect voltage supply.**

- ▶ Only connect the device to voltage sources which correspond with the electrical requirements specified on the name plate.
- ▶ Only use earth/grounded sockets with a protective earth conductor.
- ▶ Only use the mains/power cord supplied.



#### **WARNING! High voltage**

- ▶ Before taking this device in operation, always make sure that this equipment is properly earthed / grounded by means of the supplied mains/power cord.



Do not use a multiple socket extension cord.

1. Verify that your supply voltage matches the voltage specified on the name plate of your device.
2. Verify that the mains/power switch is in the OFF position.
3. Plug the mains/power cord into the mains/power cord socket on the rear of the device.

#### 4.4.2 Drain connection

The refrigeration drain is used in the following events:

- For draining the condensation water, e.g. when using refrigeration, temperature rampings or incubating large volumes (> 20 % fill, especially in larger flask volumes  $\geq 1$  L).
  - The refrigeration drain can be used continuously to drain condensation water. In case of ongoing condensation problems, connect also the additional supplied tubing to the base drain in addition (Fig. 3-2).
  - For draining the flush water after contamination e.g., for cleaning purpose. See the Decontamination chapter for further information (see *Cleaning/decontamination on p. 87*).
1. Connect the supplied drain tubing to the refrigeration drain on the right side of the device before using the device.
  2. Insert the other end of the drain tubing into a container or into an accessible house water drain.
  3. Allow the condensation or flush water to drain completely.  
Leave the drain tubing connected while using refrigeration or flushing the chamber bottom cover.
  4. Disconnect the drain tubing after use.



The refrigeration drain can be used continuously to drain condensation water. In case of ongoing problems with condensation, connect the additional tubing to the base drain.

#### 4.5 Connecting to VisioNize Lab Suite

The following steps describe how to connect a device with VisioNize touch interface to VisioNize Lab Suite.

##### Requirements:

- Network socket of the local network near the device
- Standard Ethernet cable
- Internet access with open ports to the following URL:
  - URL: [www.eppendorf.com](http://www.eppendorf.com)
  - Port: 443 TCP
  - Protocol: MQTT via web sockets



To avoid unauthorized access, data loss, sample loss, and data abuse, protect your VisioNize touch enabled device against unauthorized access from the Internet.

- ▶ Ask your IT system administrator for advice.

##### Connect to the network

###### Prerequisites

- All devices are integrated into the local network and have the port open to the following URL [www.eppendorf.com](http://www.eppendorf.com).
- The software version of the device is compatible with VisioNize Lab Suite. (Check by tapping *Menu > Settings > About this device*: scroll down to *Software version*.)
- The user must own an active subscription to the VisioNize Lab Suite.



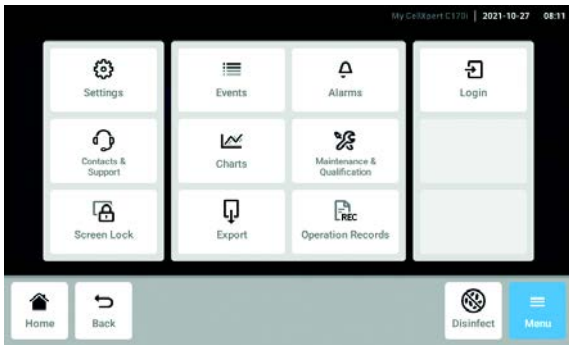

1. Connect the ethernet socket at the rear site of the device to an unlocked socket of the network with a standard ethernet cable.
2. To check the network connection, open the settings on the touch screen of the device.
3. Tap *Menu > Settings > System Settings > Network*.

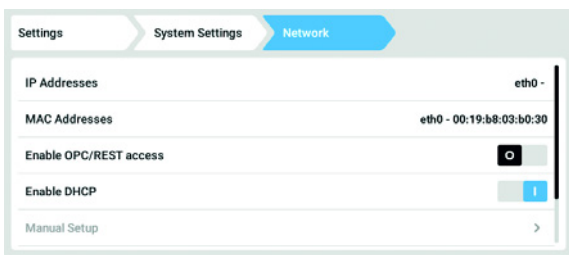

4. Switch on DHCP as network protocol.

## DHCP

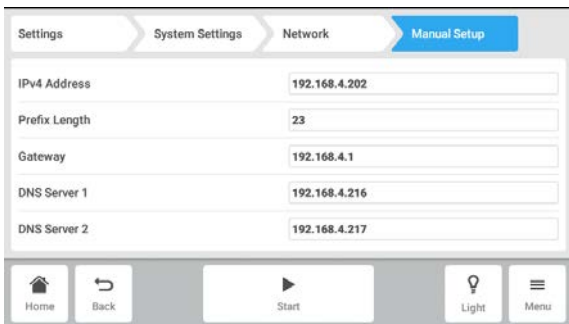

5. If you do not use DHCP, switch off *Enable DHCP* and tap *Manual Setup*.
6. Enter the device settings.

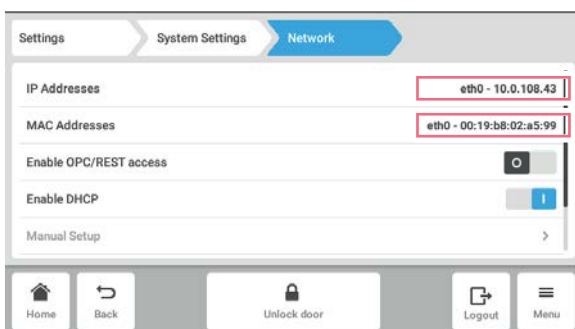

7. To check the entries, tap *Back*.  
 When the device is successfully connected, the IP address is displayed next to *IP Addresses*.  
 If the IP address is not displayed, note the MAC address and contact your local IT administrator.

8. To check if your device is correctly configured to connect to VisioNize, use the function *Check Cloud Connectivity Prerequisites* in *Menu > Contacts & Support > Diagnostics*.

### 4.5.1 Registration to VisioNize Lab Suite

Log in to your account by visiting: [https://<your\\_tenant\\_name>.visionizelabsuite.eppendorf.com](https://<your_tenant_name>.visionizelabsuite.eppendorf.com). To request a demo or learn more about VisioNize Lab Suite, visit <https://www.eppendorf.com/visionize>. To subscribe to VisioNize Lab Suite, visit: <https://www.eppendorf.com/visionize-subscription>.



Device registration and management of device information is only possible for a VisioNize Lab Suite user with the administrator rights (user role: Lab Manager).

#### Prerequisites

- A device license must be added when subscribing to VisioNize Lab Suite.

1. Log in to your VisioNize Lab Suite account as an administrator.
2. Navigate to the *Device management*.
3. Click *Add device +*.
4. Select a VisioNize touch enabled device.
5. Enter the serial number.



You will find the serial number on the name plate.

6. Navigate to *Menu > Settings > About this device* at the device display to check the serial number.
7. Confirm by clicking *Submit*.
8. Navigate to the tab *Requests* in the device management app.
9. Select the device you want to add.
10. Click *Accept device* once you have connected the device to your local network.  
The device is added to the device list in the *Device* tab.
11. If the button *Accept device* is grayed out, check if your device is connected to the local network.

## 5 Operation

### 5.1 Opening the door

---



#### **WARNING! Risk of crushing fingers with door**

- ▶ Do not reach between the door and device, or into the door locking mechanism when opening and closing the door.



#### **CAUTION! Risk of injury due to moving parts**

- ▶ Be careful when you open the door. The door opens upwards.
- ▶ Always fully open the door so it can not fall and close.

1. To open the door, pull the door handle and move the door up and into the open position.

When the latching mechanism of the door is released:

- The door open symbol is displayed.
- The heater turns off.
- The shaker stops.
- The chamber light turns on if set to *Auto*.
- The fans continue for 30 s.



When the door is closed, the shaker will continue to operate under the previously entered values.

### 5.2 Loading the device

---



#### **WARNING! Risk of personal injury**

- ▶ Do not reach inside the chamber until the shaker has come to a complete stop.



#### **NOTICE! Material damage due to imbalance**

Damage to the drive or platform

- ▶ Only operate the device when the platform is installed.
- ▶ Evenly distribute the weight of the flasks on the platform.

#### Prerequisites

- The interchangeable platform is installed.

1. Squeeze the handle and pull out the sub-platform.
2. Place the flasks or other vessels in corresponding accessories.
3. Push the sub-platform back into the device.



The sub-platform can only be pushed back when the handle is down.

### **5.3 Switching the device on/off**

#### Prerequisites



- The device is connected to mains/power supply.
1. Press the mains/power switch to switch on the device.  
The device is switched on and ready for operation.
  2. Press the mains/power switch to switch off the device.

### **5.4 Automatic restart after power failure**















The device is equipped with an automatic restart function. In the event of a power failure, the shaker's non-volatile memory retains all stored information. If the shaker was in operation prior to the power interruption, the shaker will begin to operate at its last entered set values. The event log shows this as "Device Powered Off" and "Device Powered On" events.

## 6 Operating control overview











### 6.1 Operating the user interface

-  The touch screen is designed to be operated with your fingers only without the need for tools. You can wear laboratory gloves made of nitrile or latex. Alternatively, you can also use a stylus, for example, when thick gloves need to be worn in the laboratory.
-  If liquid comes into contact with the touch screen, the functions displayed on the touch screen may be triggered.
  - ▶ Do not drop any liquids onto the touch screen.
  - ▶ Do not spill any liquids onto the touch screen.

### 6.2 Symbols

Symbol	Description
	Activate function
	Deactivate function
	Door open
	Door close
	Active alarm
	Notification
	Open alarm setting
	Open event log
	Open chart
	Balance Master optimization
	Open temperature function
	Open to display offset values
	Open speed function
	Open timer function

**Operating control overview**Innova® S44i  
English (EN)

Symbol	Description
	Chart duration
	Close
	Filter
	Export data
	Chamber light on/off
	Open photosynthetic light function
	Change function position
	Default alarm setting
	Fine increment adjustment
	Display recently used values

## 6.3 Home screen overview

### 6.3.1 Home screen

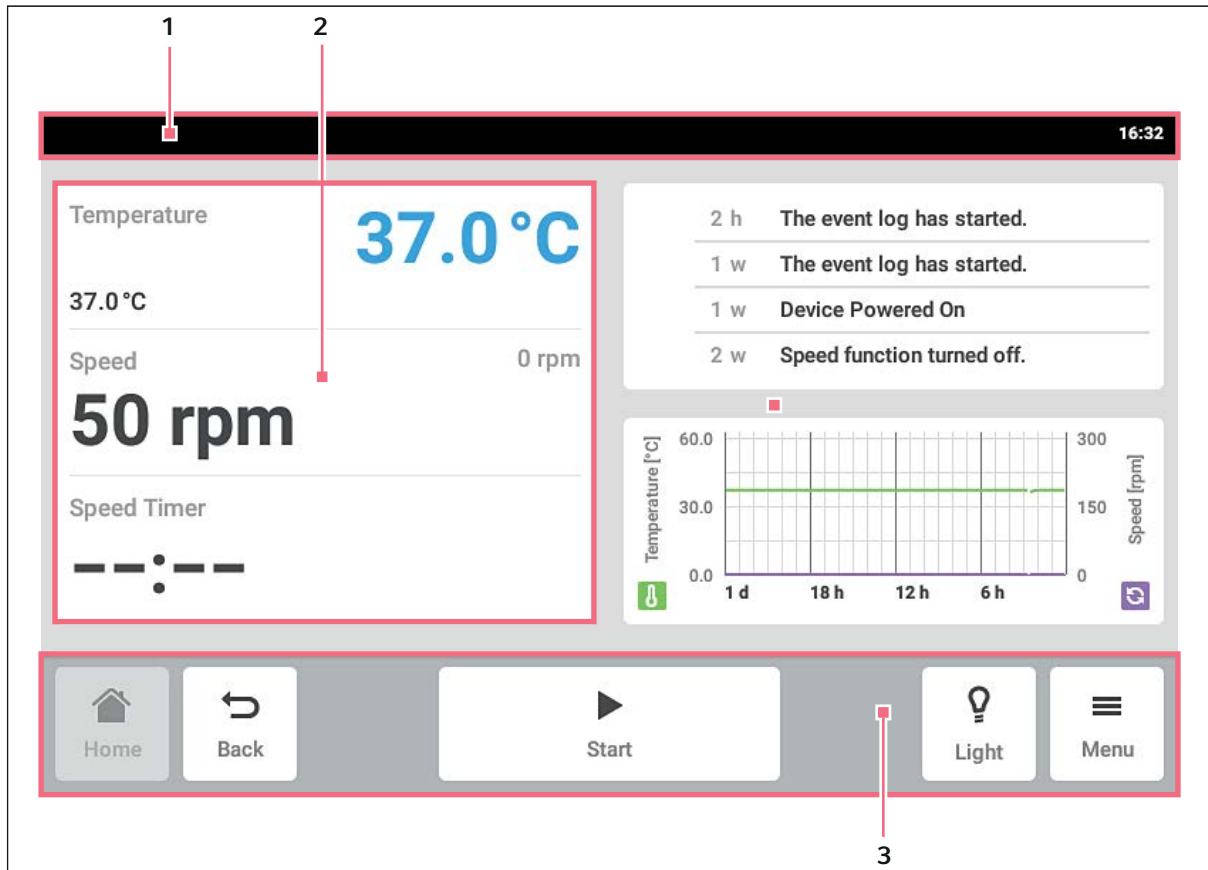

Fig. 6-1: Home screen

**1 Status bar**

Information on the user, time, device status, device name

**2 Function area**

Standard functions of the device

**3 Toolbar**

Buttons for device navigation and operation

## 6.3.2 Function area

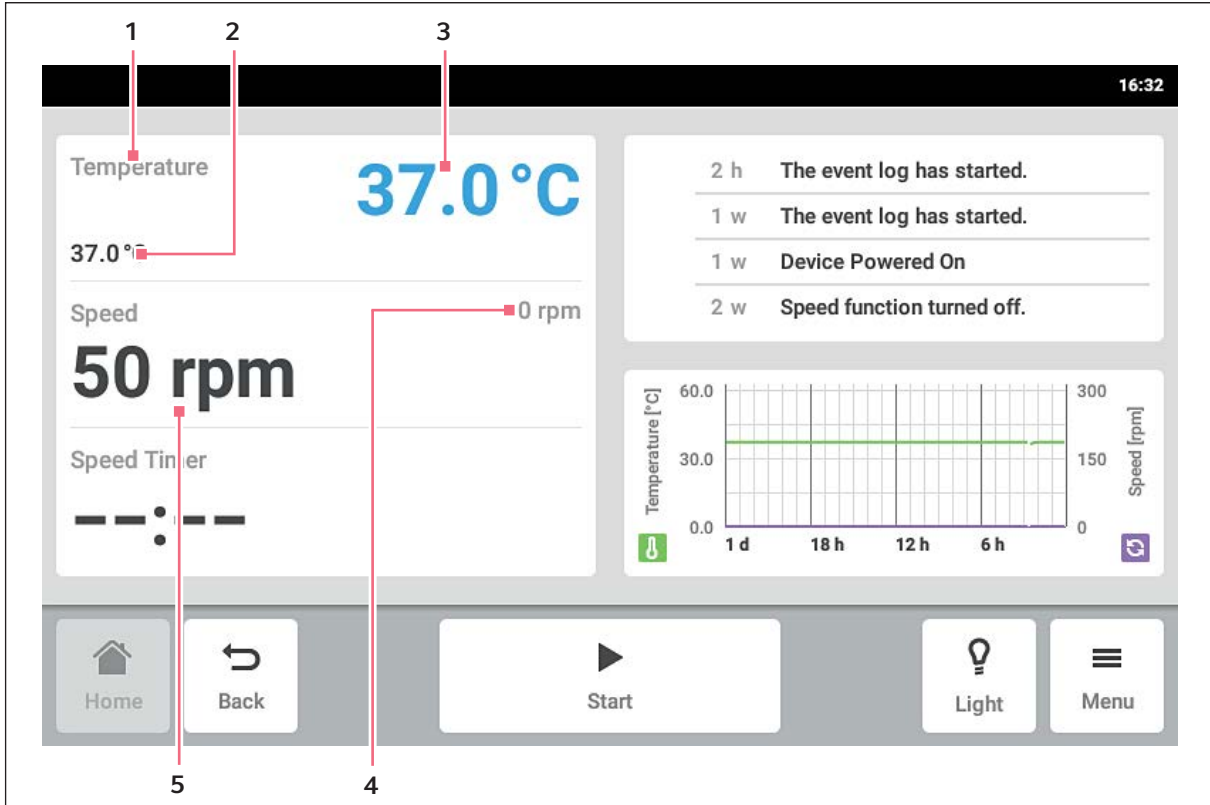

Fig. 6-2: Function area

**1 Function name****2 Set value of an active function**

The set value of an active function is displayed in small black numbers.

**3 Actual value of an active function**

The actual value of an active function is displayed in large blue numbers.

**4 Actual value of an inactive function**

The actual value of an inactive function is displayed in small gray numbers.

**5 Set value of an inactive function**

The set value of an inactive function is displayed in large black numbers.



### 6.3.3 Toolbar

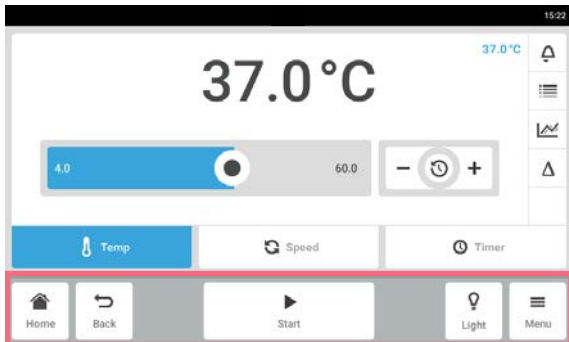

- ▶ Tap the *Home* button.  
The home screen appears.
- ▶ Tap the *Back* button.  
The previous window appears.
- ▶ Tap the *Menu* button.  
The menu appears. With the menu items, functions such as *Settings*, *Alarms* or *Event Log* can be opened.

### 6.3.4 Status bar/information bar

If messages are present, the information bar appears instead of the status bar. The information bar displays alarm messages and warning messages.

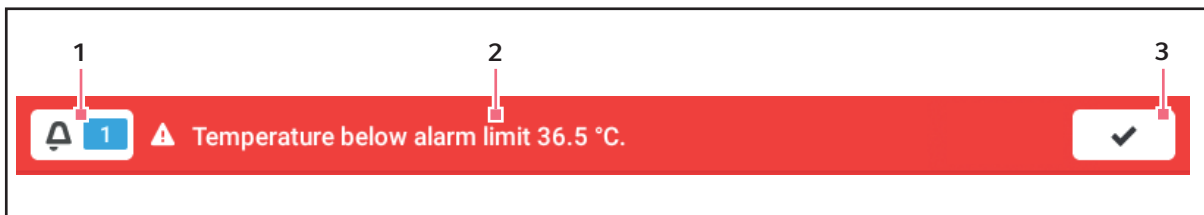

Fig. 6-3: Information bar

#### 1 Number of unacknowledged messages

#### 2 Current message

Red information bar: Unacknowledged alarm messages.

Yellow information bar: Unacknowledged warning messages.

#### 3 Acknowledging the current message

When the current message is acknowledged, it is deleted from the information bar.

When all the messages have been acknowledged, the information bar disappears.

### Editing the information bar

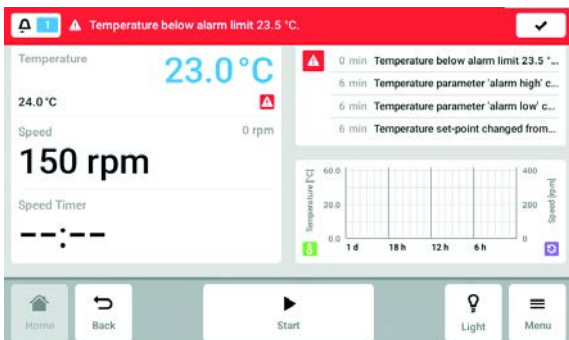

- ▶ To display the log, tap the number next to the bell symbol.
- ▶ To confirm the current message, tap the checkmark symbol.

## Operating control overview

Innova® S44i  
English (EN)

### Editing the message

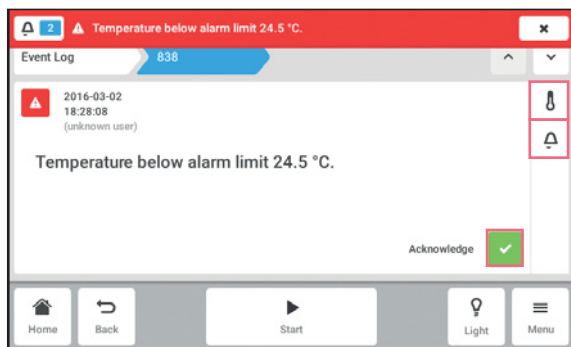

- ▶ To call up the current message, tap the information bar. The message appears in the log.
- ▶ To acknowledge the message, tap the *Acknowledge* button.
- ▶ To change the alarm limits, tap the *Alarm* (bell symbol) button.
- ▶ To change the set value of the function, tap the button above the *Alarm* symbol.

## 6.4 Function control

### 6.4.1 Selecting the function

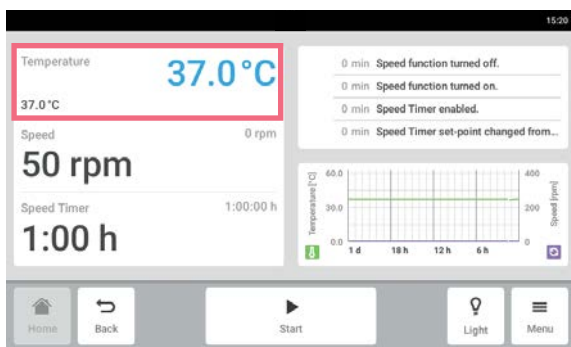

- ▶ Tap the function in the function area. The window for setting the set value appears.

### 6.4.2 Setting the set value

#### Setting the set value with the slider

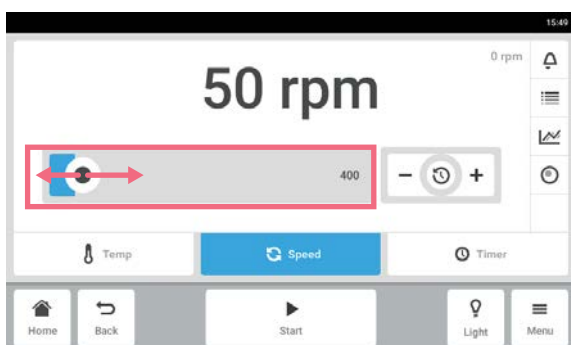

- ▶ Tap the slider and drag it to the right or to the left. The set value changes.

### Changing the set value incrementally with the fine adjustment

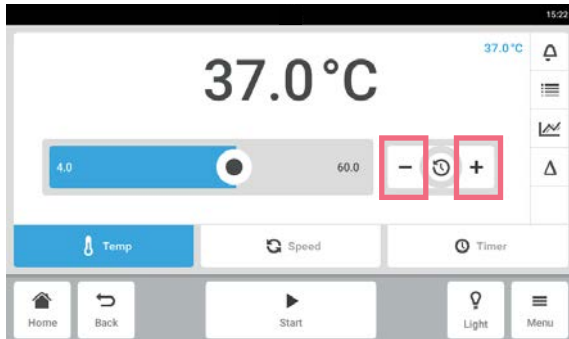

- ▶ Tap the + button.  
The set value is incrementally increased.
- ▶ Tap the - button.  
The set value is incrementally decreased.

### Selecting the last used set value

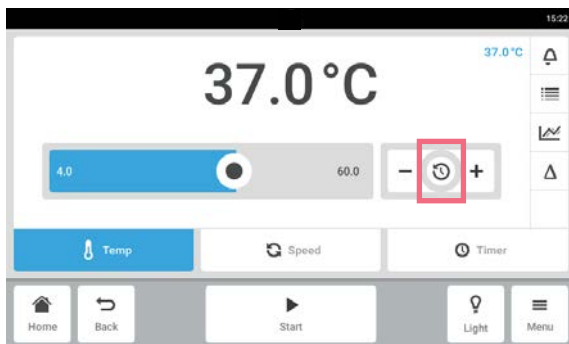

1. Tap into the center of the fine adjustment.  
A list with the last used set values is displayed.
2. Select the set value.

### Entering the set value with the number pad

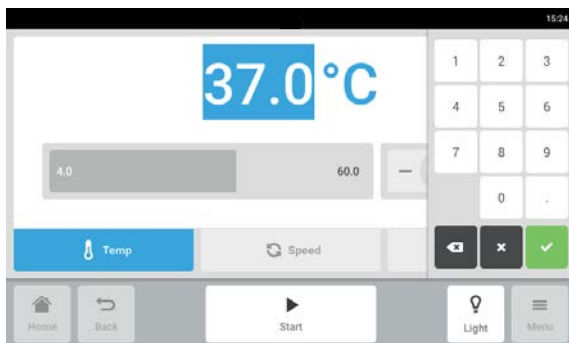

1. Tap the set value.  
The number pad appears.
2. Enter the new set value.
3. Confirm your entry.  
The entry is completed. The number pad disappears.

### 6.4.3 Switching between functions

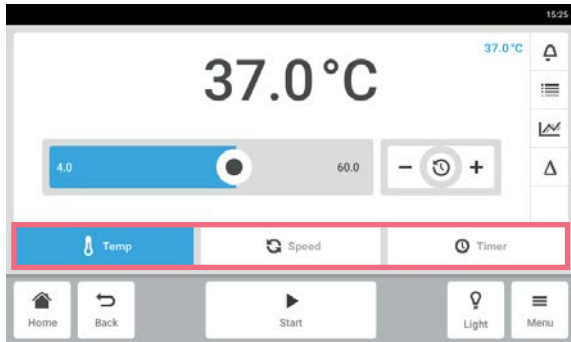

- ▶ To switch to another function, tap the symbol of the function.  
The active function is highlighted in blue.

## 7 Starting the application

### 7.1 Starting and stopping the device

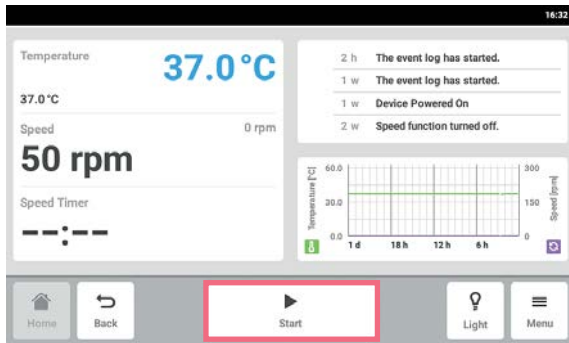

- ▶ Tap the *Start* button on the toolbar.  
The device starts with the set values.

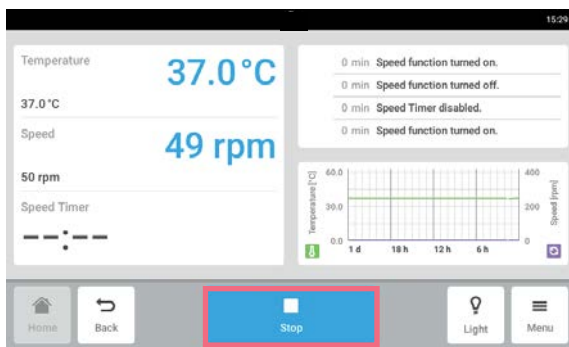

- ▶ Tap the *Stop* button on the toolbar.  
The device stops.

### 7.2 Setting the temperature value



The temperature value can be adjusted with the slider or with the number pad.

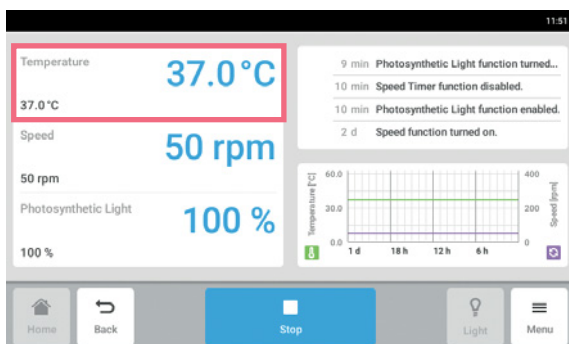

1. Tap the *Temperature* function on the home screen.  
The temperature parameters screen appears.

## Starting the application

Innova® S44i  
English (EN)

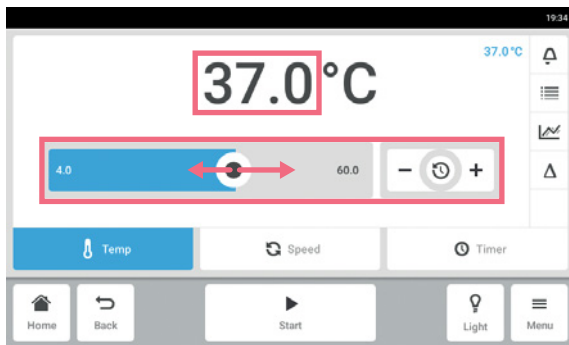

2. Tap the displayed set value.  
The number pad appears.

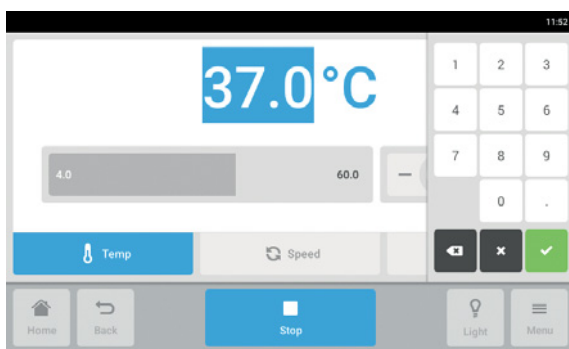

3. Enter the desired set value with the number pad.
4. Confirm your entry.  
The number pad disappears.
5. To return to the home screen, tap the *Home* button.

## 7.3 Setting the speed value

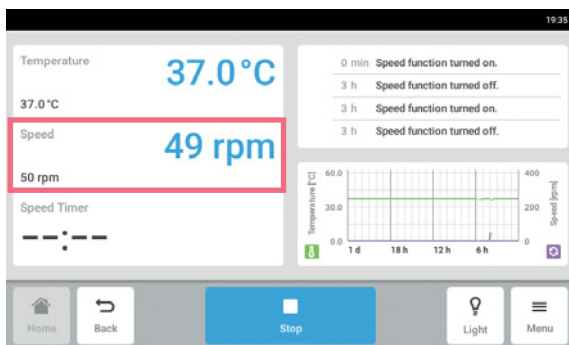

1. Tap the *Speed* function on the home screen.  
The speed parameters screen appears.

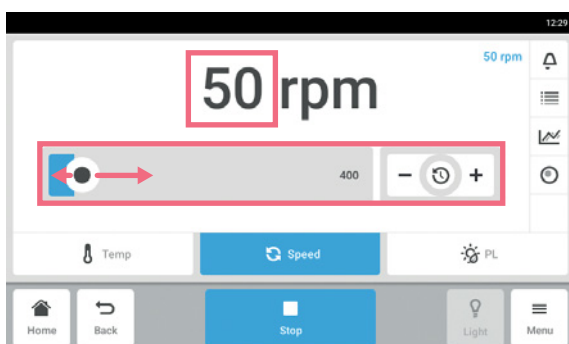

2. Tap the displayed set value.  
The number pad appears.



The speed value can also be adjusted with the slider.

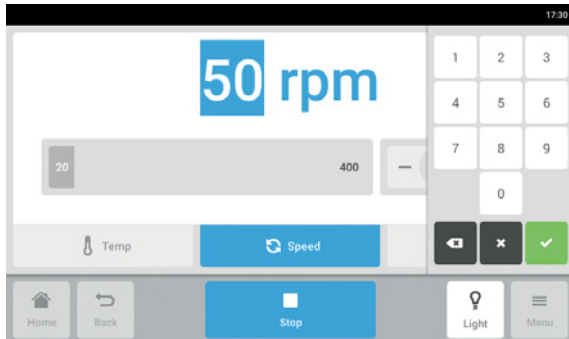

3. Enter the desired set value with the number pad.
4. Confirm your entry.  
The number pad disappears.
5. To return to the home screen, tap the *Home* button.

## 7.4 Setting the speed timer

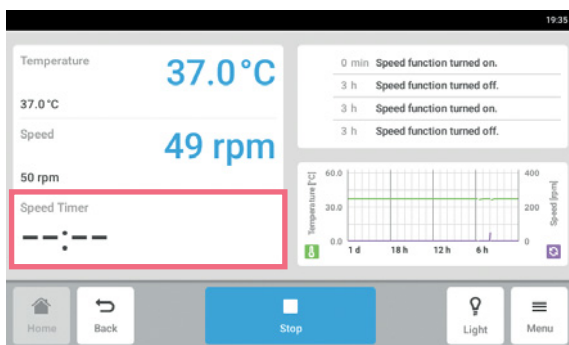

1. Tap the *Speed Timer* function on the home screen.  
The speed timer screen appears.

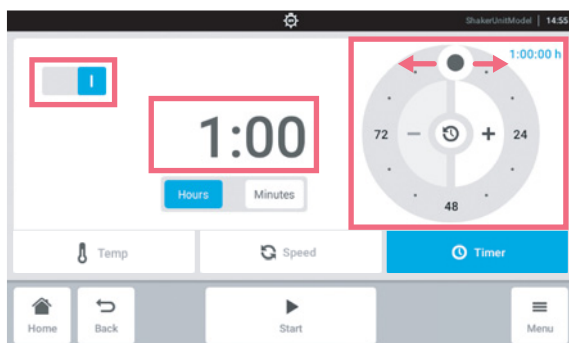

2. Tap the displayed time.  
The number pad appears.



The speed timer can also be adjusted with the rotary adjuster.

## Starting the application

Innova® S44i  
English (EN)

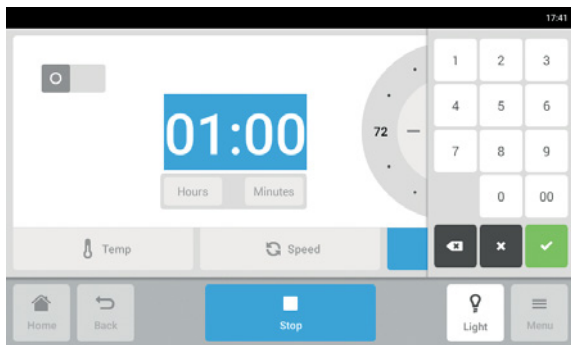

3. Enter the desired time with the number pad.
4. Confirm your entry.  
The number pad disappears.
5. Activate or deactivate the speed time function.
6. To return to the home screen, tap the *Home* button.

## 7.5 Setting the photosynthetic light



1. Tap the *Photosynthetic Light* function on the home screen.  
The photosynthetic light parameters screen appears.

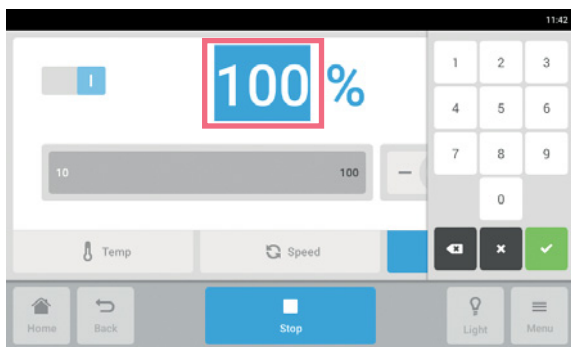

2. Tap the displayed set value.  
The number pad appears.
3. Enter the desired set value with the number pad.
4. Confirm your entry.  
The number pad disappears.



The photosynthetic light value can also be adjusted with the slider.

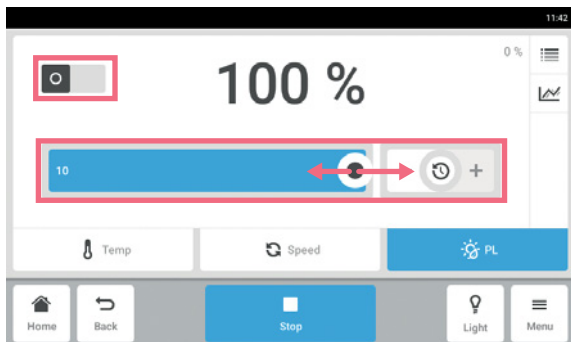

5. Activate or deactivate the photosynthetic light function.
6. To return to the home screen, tap the *Home* button.



## 8 The Menu area

The *Menu* area contains all of the software settings.

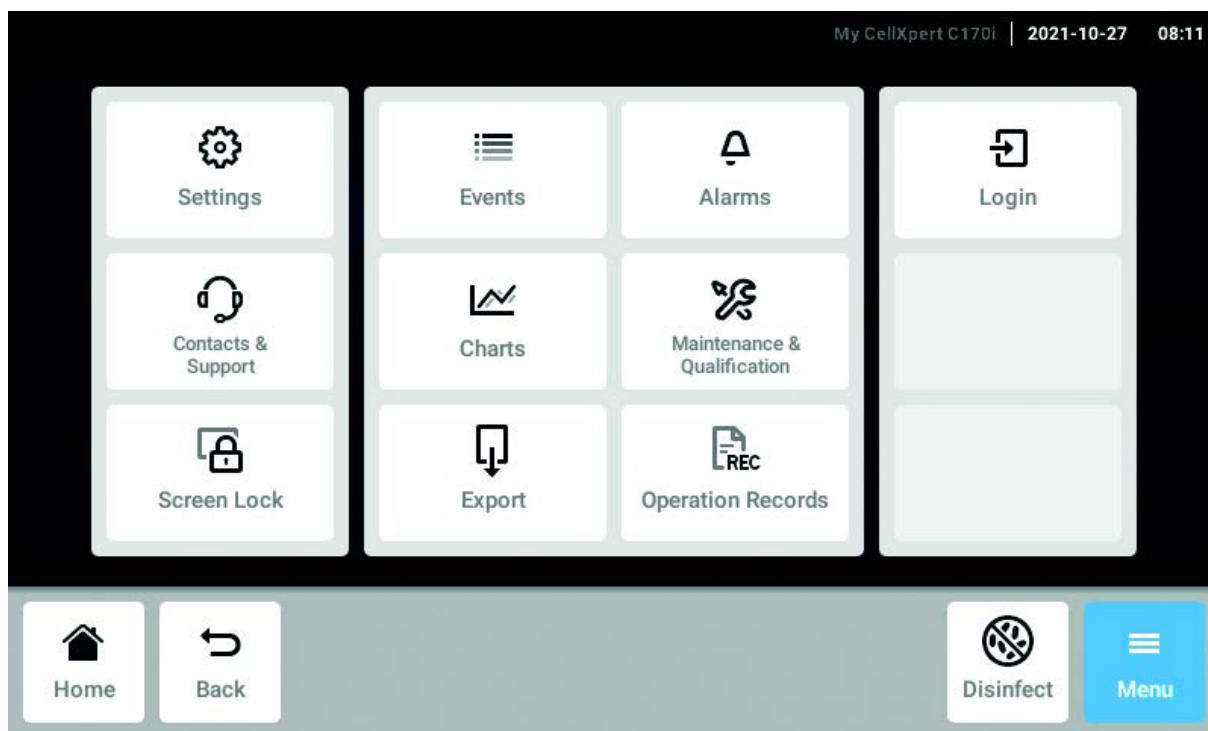

Fig. 8-1: The *Menu* screen

### **Settings**

- Information on the device and licenses
- Device, maintenance and system settings
- Activate user management

### **Contacts & Support**

- Information on local contact persons

### **Screen Lock**

- Lock and unlock the touch screen
- Clean the touch screen

### **Events**

- Event log with messages and alarms

### **Charts**

- View functions in a diagram

### **Export**

- Export charts, logs, data and *Operation Records*

### **Alarms**

- Activate alarms and set alarm limits

### **Maintenance & Qualification**

- Perform recurring tasks

### **Login/Logout**

- User management

### **Users**

- User profile settings

### **Operation Records**

- Define and export records of your experiments

## The Menu area

Innova® S44i  
English (EN)

### 8.1 Settings

This area provides you with information on the device. You can adjust device settings and enable the user management.

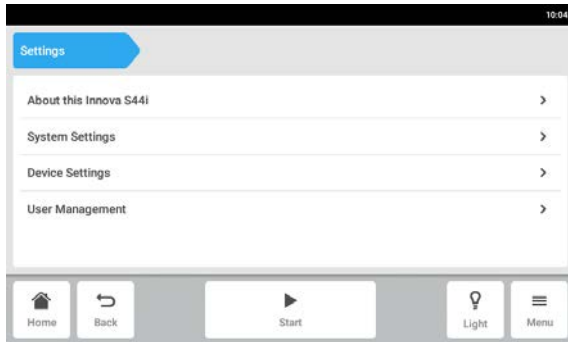

- ▶ The following settings are available:
  - *About this Innova S44i*: View information on the device and licenses.
  - *System Settings*: Configure the date, time and network.
  - *Device Settings*: Configure the alarm and display.
  - *User Management*: Create user management (see *User administration on p. 75*).

#### 8.1.1 The *About this Innova S44i* menu item

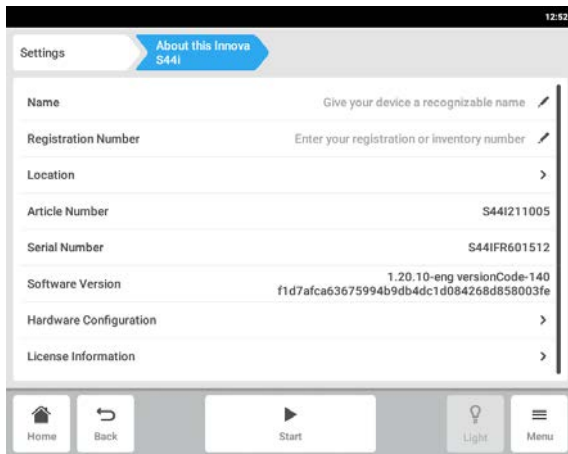

- ▶ Tap the *Menu > Settings > About this Innova S44i* menu item.
 

The following fields are available:

  - *Name*: Enter the device name.
  - *Registration Number*: Enter the inventory number of the device.
  - *Location*: Enter the location of the device.
  - *Article Number*: The article number of the model
  - *Serial Number*: The serial number of the device, see the name plate.
  - *Software Version*: User software version
  - *Hardware Configuration*: View information on optional extensions.
  - *License Information*: View information on licenses.

### Location – Entering the location of the device

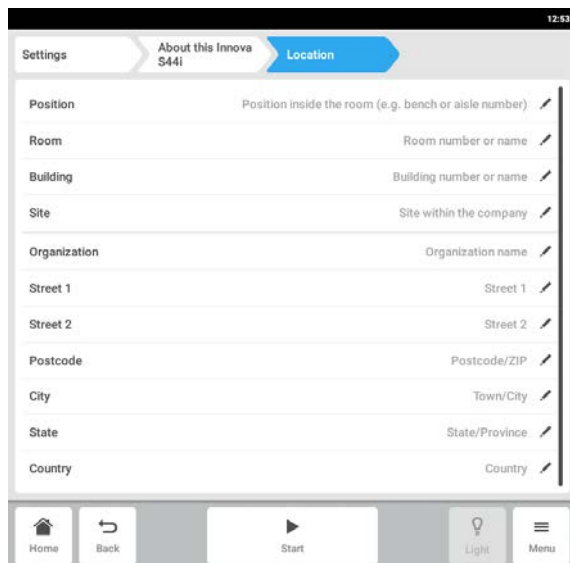

- ▶ Enter information on the location of the device.

### 8.1.2 The System Settings menu item

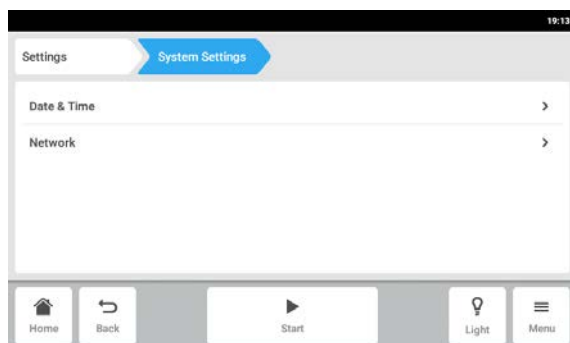

1. Tap the *Menu > Settings > System Settings* menu item.

The following settings are available:

- *Date & Time*: Set the date, time and time zone.
- *Network*: Set the parameters for network operation.

## The Menu area

Innova® S44i  
English (EN)

### 8.1.2.1 Date & Time – Setting the date and time automatically

#### Prerequisites

- The device is connected to the network.
- A time server is available.



Changing the date, time or time zone may temporarily affect the appearance of the chart. The log may be incorrectly sorted.

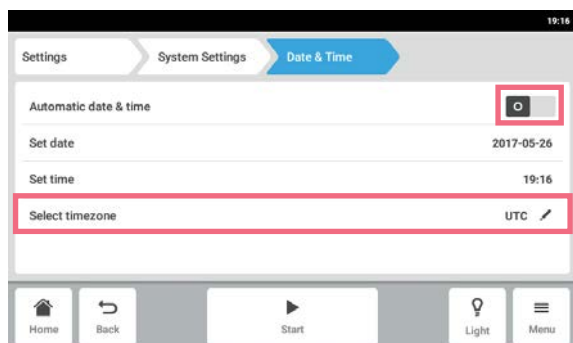

1. Tap the *Menu > Settings > System Settings > Date & Time >* menu items.
2. Switch on the *Automatic date & time* switch.
3. Tap the *Select timezone* menu item.

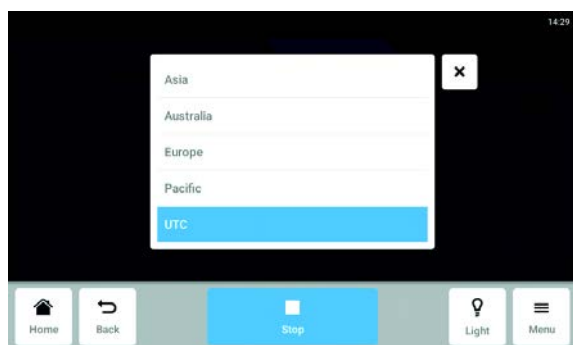

4. Select the continent.

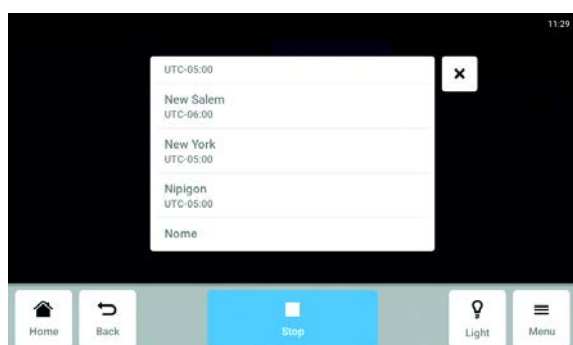

5. Select the time zone.
6. Close the selection.  
The *Date & Time* menu appears.

### 8.1.2.2 Date & Time – Setting the date and time manually



Changing the date, time or time zone may temporarily affect the appearance of the chart. The log may be incorrectly sorted.

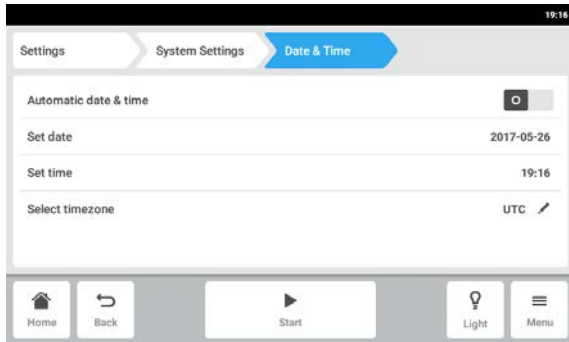

1. Tap the *Menu* > *Settings* > *System Settings* > *Date & Time* menu items.
2. Switch off the *Automatic date & time* switch. The *Set date* and *Set time* menu items become active.
3. Tap the *Set date* menu item.

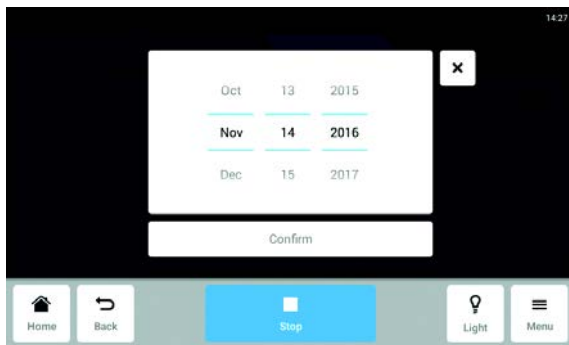

4. Set the current date.
5. Tap the *Confirm* button. The date is saved. The *Date & Time* menu appears.

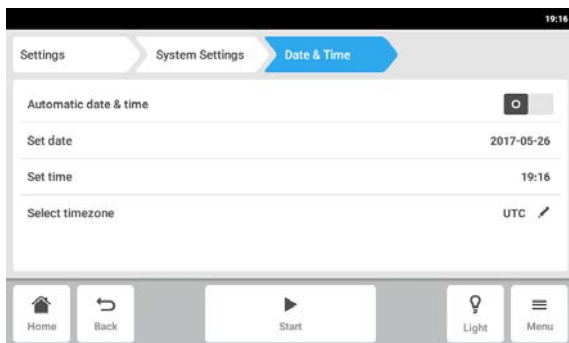

6. Tap the *Set time* menu item.

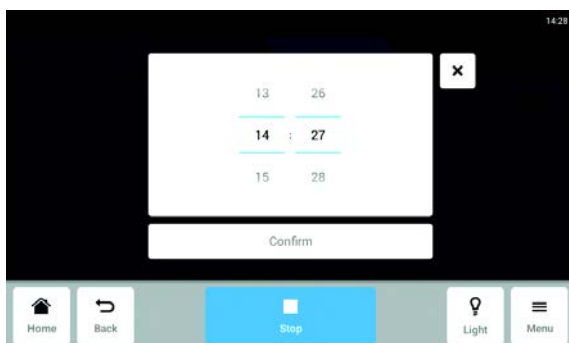

7. Set the time.
8. Tap the *Confirm* button. The time is saved. The *Date & Time* menu appears.

## The Menu area

Innova® S44i  
English (EN)

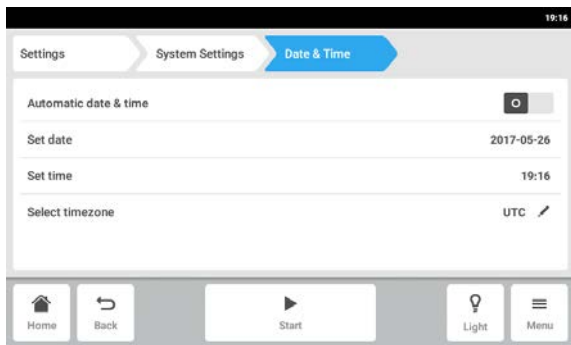

9. Tap the *Select timezone* menu item.

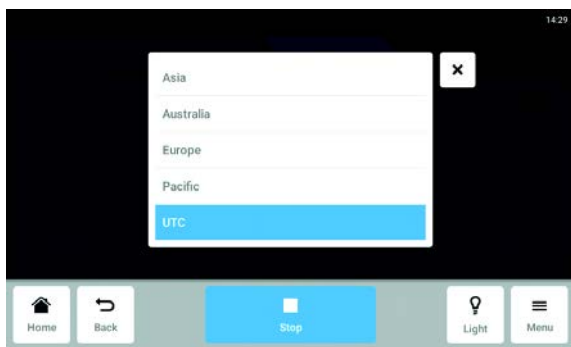

10. Select the continent.

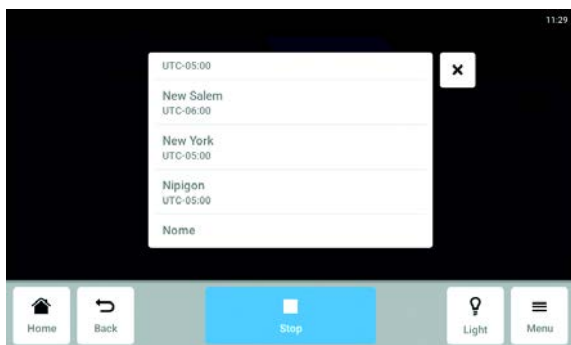

11. Select the time zone.

12. Close the selection.

The *Date & Time* menu appears.

### 8.1.2.3 Network

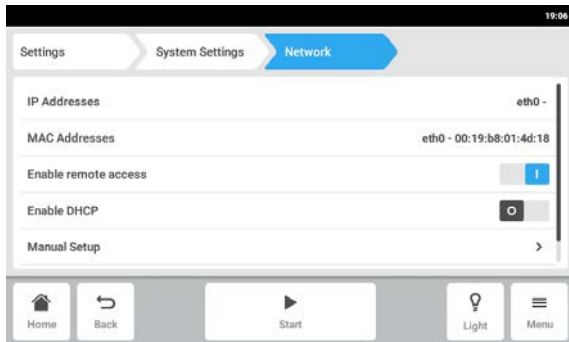

1. Tap the *Menu > Settings > System Settings > Network* menu items.  
 The following settings are available:
  - *IP Adresses*: Current IP address of the device
  - *MAC Adresses*: Address by which the device can be uniquely identified in the network
  - *Enable remote access*: Allow device communication with external software.
  - *Enable DHCP*: The device uses an IP address that was assigned by a DHCP server.
  - *Manual Setup*: Enter the network settings manually. Active when the *Enable DHCP* switch is switched off.

#### Network – Entering the network settings manually

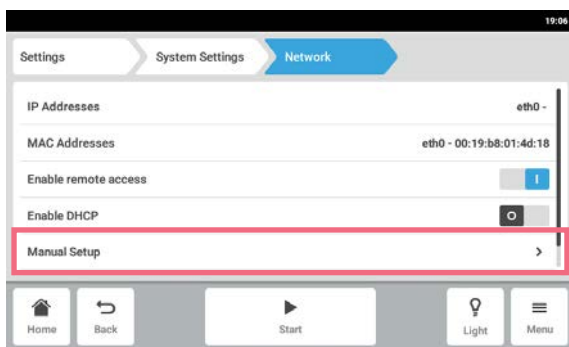

2. Tap the *Menu > Settings > System Settings > Network > Manual Setup* menu item.

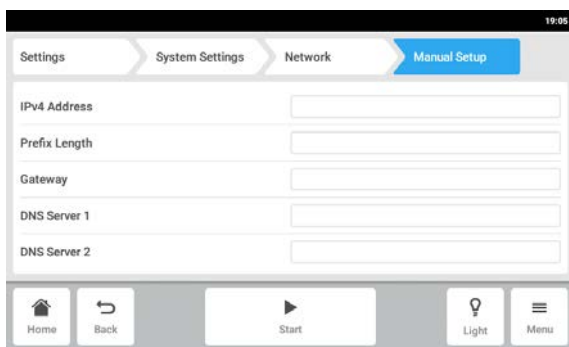

3. To enter a value, tap the edit box.  
 The number pad appears.
4. Enter the value.
5. Confirm your entry.
6. Tap the *Back* button.  
 The data is saved. The window for the network settings appears.

## The Menu area

Innova® S44i  
English (EN)

### 8.1.3 The *Device Settings* menu item

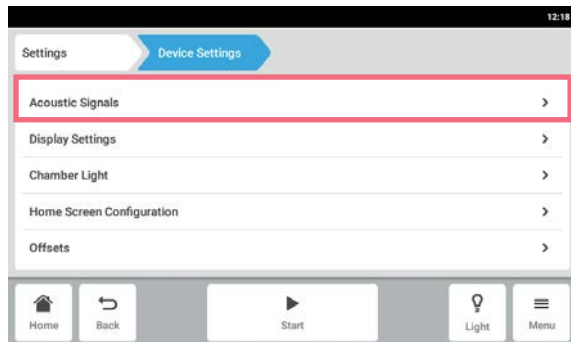

1. Tap the *Menu > Settings > Device Settings > Device* menu items.

The following settings are available:

- *Acoustic Signals*: Set the audible alarm.
- *Display Settings*: Set the brightness, power saving mode and timeout of the display.
- *Chamber Light*: Set the light in set chamber.
- *Home Screen Configuration*: Configure the home screen.
- *Offsets*: Set and calculate the temperature offset.

#### 8.1.3.1 *Acoustic Signals* – Setting the audible alarm

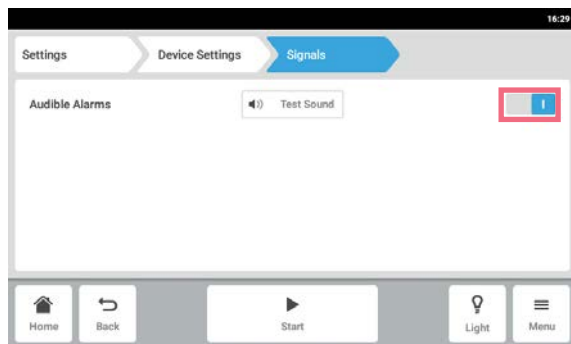

1. Tap the *Menu > Settings > Device Settings > Acoustic Signals* menu items.
2. To enable or disable the audible alarm, tap the *O I* switch.
3. To test the audible alarm, tap the *Test Sound* button.

#### 8.1.3.2 *Display settings* – Setting the touch screen

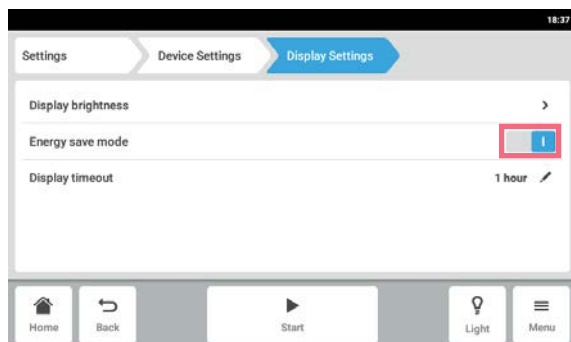

1. Tap the *Menu > Settings > Device Settings > Display Settings* menu items.

The following settings are available:

- Display brightness
  - Energy save mode
  - Time after which the display is dimmed
2. To enable or disable the energy save mode, tap the *O I* button.
  3. Set the time after which the display will be dimmed.
  4. Configure the *Display timeout* and *Display brightness* settings accordingly.



### 8.1.3.3 Chamber Light – Setting the chamber light

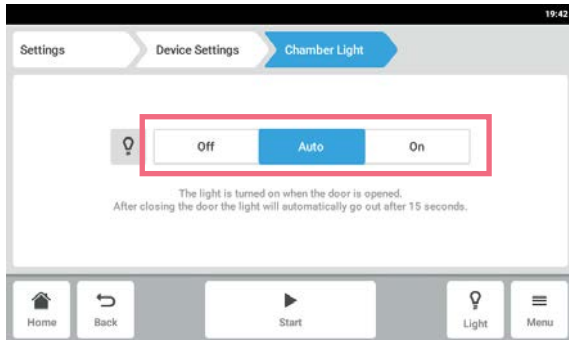

1. Tap the *Menu > Settings > Device > Chamber Light* menu items.

The following settings are available:

- *Off* - The light is always off.
- *Auto* - The light is on when the door is open. After the door is closed, the light will automatically go out after 30 seconds.
- *On* - The light is always on.

2. Tap the *Off | Auto | On* buttons.

### 8.1.3.4 Home Screen Configuration – Configuring the home screen

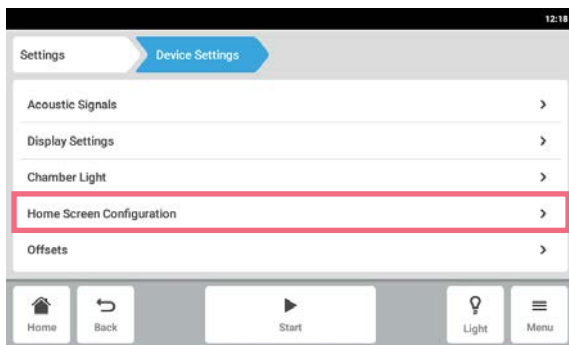

1. Tap the *Menu > Settings > Device Settings > Home Screen Configuration* menu items.

You can specify which functions appear on the home screen. You can set the order of the functions on the home screen. You can choose the following functions:

- *Temperature*
- *Speed*
- *Speed Timer*

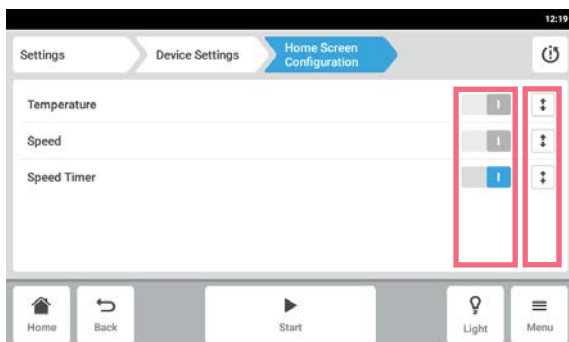

2. For a function to appear on the home screen, activate the switch.
3. Set the order of the functions on the home screen using the arrow keys.
 

On the home screen, the functions appear in the same order as in the list.

  - If 2 areas are not occupied on the home screen, the chart appears on the home screen.
  - If 4 areas are not occupied on the home screen, the chart and event log appear on the home screen.

## The Menu area

Innova® S44i  
English (EN)

### 8.1.3.5 Offset – Calculating and setting the temperature offset

The Innova S44i displays the chamber temperature measured at the temperature sensor location. To display the temperature of the media rather than the temperature of the chamber, an offset must be defined.

#### Calculating the temperature offset

1. Insert the vessel with the media.
2. Insert the external temperature probe.
3. Set the device to the desired temperature and speed.
4. To start the agitation, tap the *Start* button.
5. Allow the media to equilibrate for up to 3 hours.



The actual temperature value is displayed in blue.

6. Record the actual temperature value displayed on the *Temperature* function of the home screen.
7. Record the temperature of the media measured by the temperature probe.
8. To calculate the offset value, subtract the actual temperature from the media temperature.

The result is the offset value.

#### Example:

Media temperature 35 ° C

Actual temperature value 37 ° C

$35 - 37 = -2$

Offset = -2

#### Setting the temperature offset

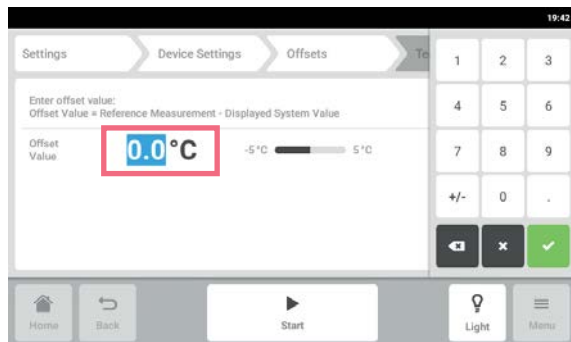

1. Tap the *Menu > Settings > Device Settings > Offsets > Temperature* menu items.  
The offset value appears.
2. Tap the displayed offset value.  
The number pad appears.
3. Enter the calculated offset value with the number pad.
4. Confirm your entry.  
The number pad disappears.

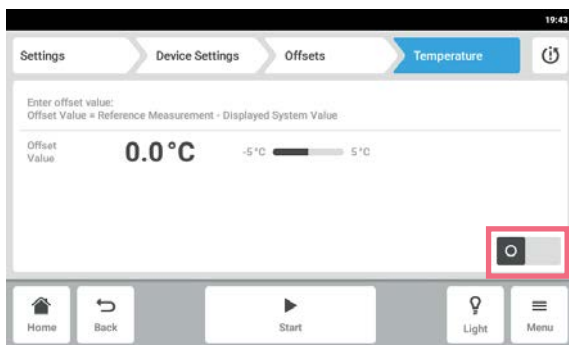

5. Activate or deactivate the temperature offset function.

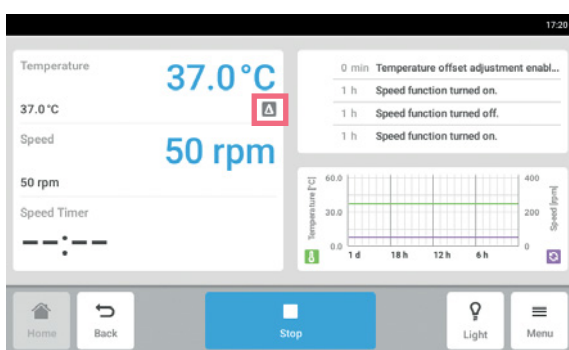

6. To return to the home screen, tap the *Home* button.

The offset symbol appears below the actual temperature on the home screen.

### 8.1.4 Balance Master function

The integrated Balance Master function enables automated imbalance detection and calculation of the optimal counterweight. If an imbalance condition is detected, it reduces the speed automatically and routes the user through a software-guided counterweight adjustment process (Balance Master optimization) to facilitate the run at the set speed with the actual load.

**For Innova S44i stacked on Innova 44, the following applies:**

- Do not perform a Balance Master calibration
- The Balance Master cannot be operated
- Observe the limitations in speed for mixed stacked devices, see the Technical Data chapter (see *Agitation on p. 98*).

### 8.1.4.1 Calibrating the Balance Master function

A successful calibration of the Balance Master is required for Balance Master optimization to operate correctly.

Counterweight set values for calibration of the Balance Master are dependent on the shaker configuration; a reference of the set values specific to the orbital diameter and position in a stack can be found in the Technical Data chapter (see *Counterweight settings for Balance Master calibration on p. 99*).

Calibrate the Balance Master of devices in stacked configurations successively starting with the top device. If shakers are stacked on an already installed device, both the new device and the existing device must be calibrated to ensure reliable results for the Balance Master optimization.



The Balance Master of an Innova S44i cannot be operated in a mixed stack with Innova 44. Do not perform a Balance Master calibration in a mixed stack configuration with Innova 44. The limitations in speed as for Innova 44 apply. See the technical data for limitations in speed in mixed configurations with Innova 44.



A successful Balance Master calibration is not a prerequisite for operating the Innova S44i safely and properly.

The Balance Master calibration is a prerequisite for using the optimization and is recommended in the following events:

- Initial installation
- Stacking of multiple shakers
- Shaker is repositioned
- Shaker is relocated

Prerequisites

- The base is installed properly.
- The single device or bottom device of a stack configuration is installed on a base.
- The device is properly leveled in its location.
- The devices are stacked properly on top of each other.
- The 5.1 cm (2 in) orbit devices are positioned on the bottom in a stack configuration.
- No other device in the stacked configuration is running the speed function.
- A triple stack must be installed on a small base. A single or double stack can be installed on a small or large base.



Balance Master calibration may only be performed on one device at a time.

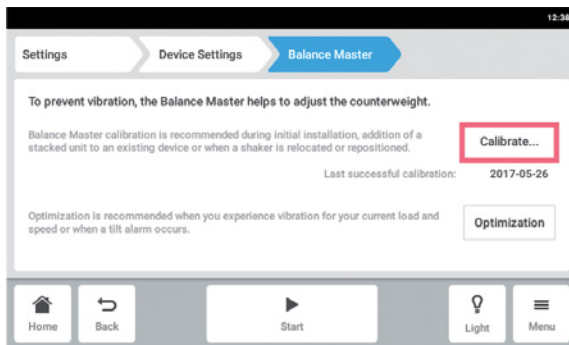

1. Tap *Menu* > *Settings* > *Device Settings* > *Balance Master*.
2. Tap the *Calibrate* button.

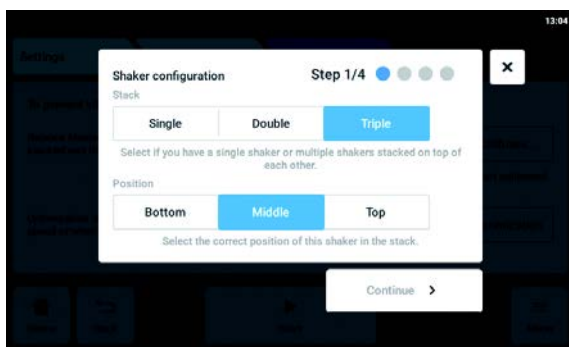

3. Select *Single*, *Double* or *Triple* according to your shaker configuration.
4. Select *Bottom*, *Middle* or *Top* according to the position of your shaker.
5. Tap the *Continue* button.

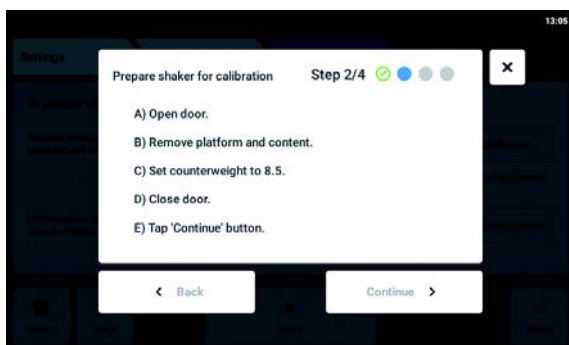

6. Open the door.
7. Remove the platform and content.
8. Set the counterweight adjustment knob to the determined value as shown on the touch screen. The value is determined according to the shaker configuration. The sample screen shows the counterweight setting 8.5 for a single device with a 2.5 cm (1 in) orbit.
9. Close the shaker door.
10. Tap the *Continue* button.

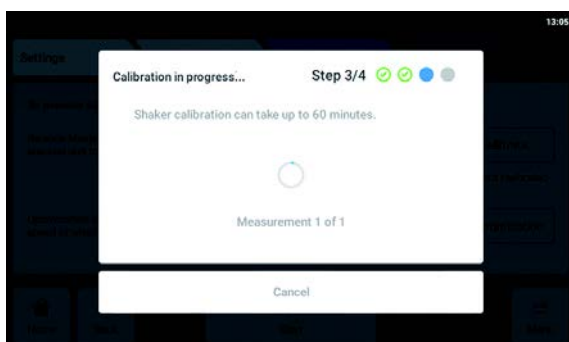

11. The device starts shaking in order to calibrate the Balance Master. The calibration can take up to 60 minutes.

## The Menu area

Innova® S44i  
English (EN)

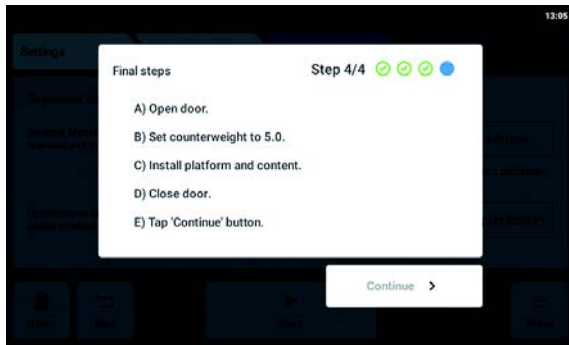

12. Open the shaker door.
13. Set the counterweight adjustment knob to the displayed value.  
The sample screen shows the value for a single device with a 2.5 cm (1 in) orbit.
14. Reinstall the platform and content.
15. Close the shaker door.
16. Tap the *Continue* button.  
The Balance Master calibration has been successful.

If the Balance Master calibration was not successful, check the following criteria:

1. Check that the shaker is properly installed, level, and without vertical movement.
2. Check that the platform is removed.
3. Check the position of the counterweight adjustment knob.
4. To start the Balance Master calibration again, tap the *Restart calibration* button.

If the Balance Master calibration is still not successful, refer to the Troubleshooting chapter.

### 8.1.4.2 Using the Balance Master function for optimization



#### NOTICE! Fatal agitation imbalance error

If a fatal error occurs, a visual and audible alarm is triggered and the device comes to stop.

1. Acknowledge the alarm.
2. Do not start the device.
3. Contact Eppendorf support.



The use of Balance Master optimization requires an initial calibration of the Balance Master during device set-up at its location.

In case excessive vibration of the platform occurs during agitation, the platform speed will automatically decrease. An alarm or a warning will appear on the touch screen. In order to mitigate vibration and run the load at target speed, run the Balance Master optimization. The Balance Master optimization will provide a value in a  $\pm$  fashion. Increase or decrease the setting of the counterweight by the determined value using the counterweight adjustment knob.

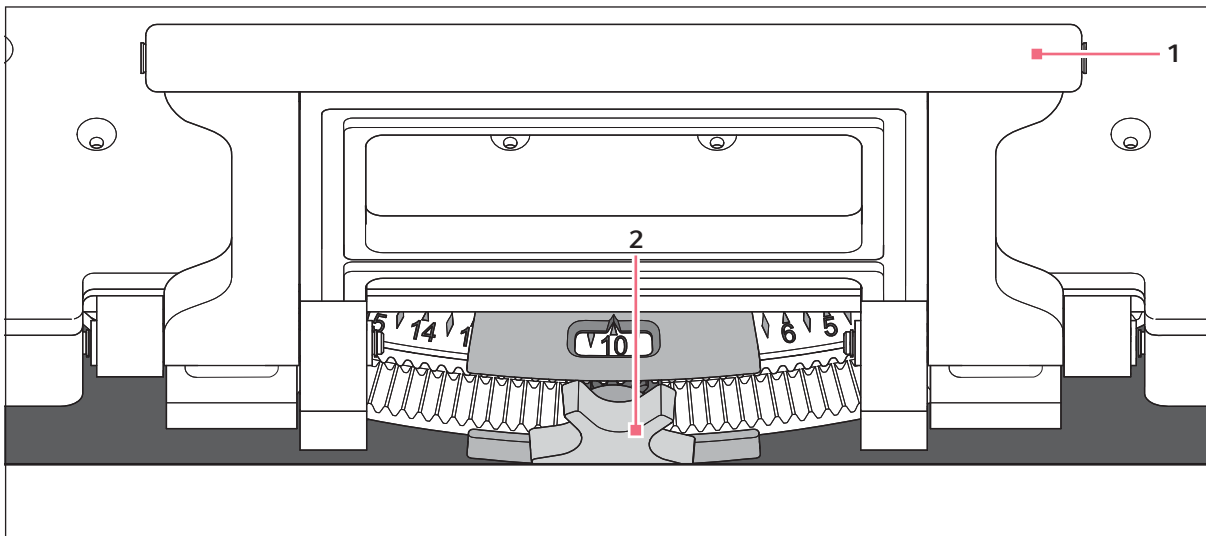

Fig. 8-2: Adjusting the counterweight

**1 Sub-platform handle**

**2 Counterweight adjustment knob**



You can start the Balance Master optimization under the following conditions:

- The device is running the speed function.
- The platform is stationary.

If the device detects an agitation imbalance, a speed alarm and a tilt state imbalance warning appear on the touch screen. The device will operate at the safest speed closest to the set value. The agitation will run at a reduced speed for the current counterbalance setting and weight load.

Prerequisites

- The Balance Master is calibrated.
- The Balance Master optimization symbol is shown below the speed value.

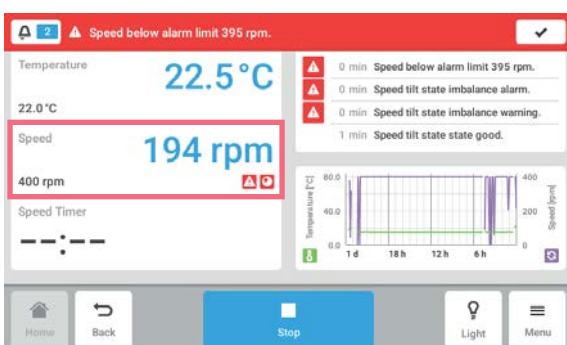

1. To access the Balance Master optimization, tap the *Speed* function on the home screen.

## The Menu area

Innova® S44i  
English (EN)

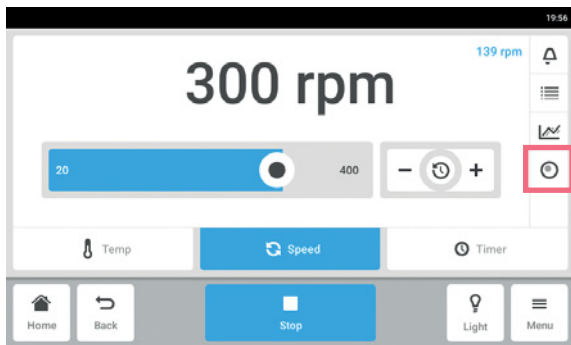

2. Tap the *Balance Master Optimization* button on the speed parameters screen.
3. Alternatively, tap *Menu > Settings > Device Settings > Balance Master*.

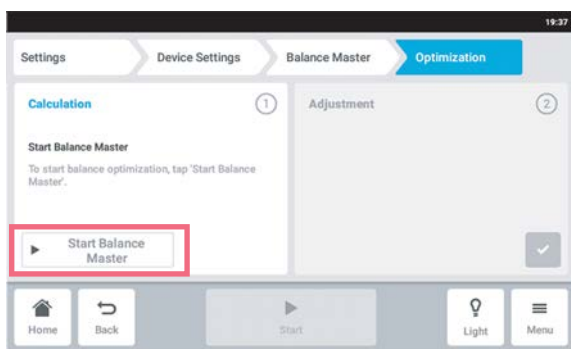

4. Tap the *Start Balance Master* button. The device starts shaking to determine the counterweight adjustment value. Balance Master optimization can take up to 10 min.

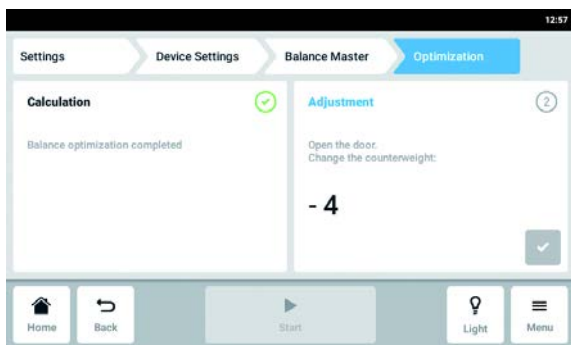

5. Open the door after the device has stopped shaking.
6. To adjust the counterweight calculated by the Balance Master, turn the counterweight adjustment knob to the right or left. Example: The previous setting of the counterweight was 2. The calculated value for the adjustment is + 8. Set the counterweight to 10.
7. To confirm the counterweight adjustment, tap the green check button.

The day and time of the Balance Master optimization is logged in the event log



### 8.1.4.3 Operating the device without the Balance Master function

In case Balance Master calibration cannot be performed (e.g. because the floor conditions at the installation site do not comply with prerequisites), the shaker performance will not be impaired. In case of an imbalance, the Innova S44i will slow down to a stable level and alert the user.

Alternatively the optimal counterweight settings can be looked up in the Technical Data chapter. To determine the optimal counterweight setting, proceed as follows:

1. Go to the Technical Data chapter (see *Optimal counterweight settings on p. 100*), choose the table according to the orbit of your device.
2. Calculate the average device load on the platform (exclude the platform weight).
3. Look up the closest value in the table that corresponds to your load.
4. Set the counterweight to the position indicated in the table.

## 8.2 Events

This area lists the device's events. You can filter, edit and export event messages.

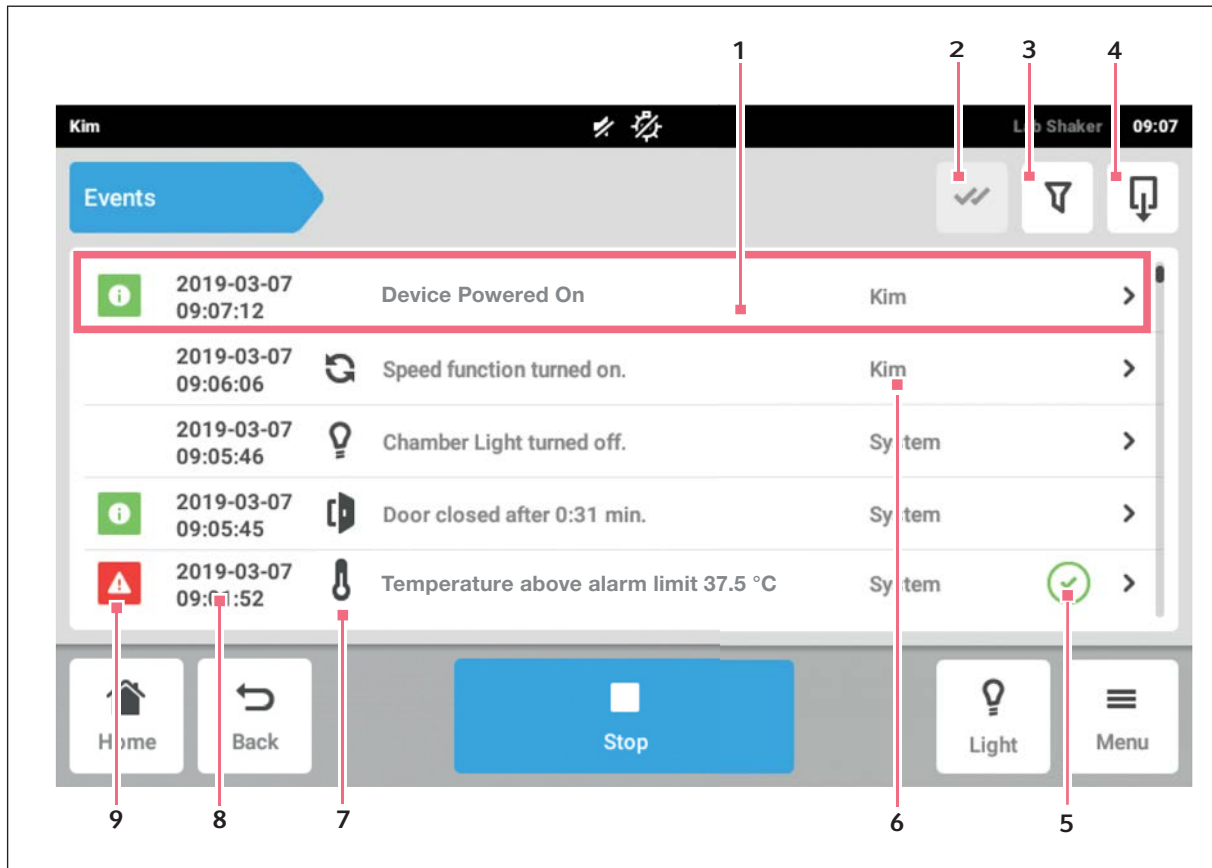

Fig. 8-3: The *Event Log* screen

- |   |   |
|---|---|
| <b>1 Overview of a message</b>  | <b>6 User, that was logged in during this time.</b> |
| <b>2 Acknowledge all notifications</b>  | <b>7 Symbol of the function</b>                     |
| <b>3 Call up filters</b><br>This button is highlighted in blue, if messages are filtered. | <b>8 Date and time of message</b>                   |
| <b>4 Export events</b><br>Export list with messages to a USB storage device.              | <b>9 Message status</b>                             |
| <b>5 Acknowledgement status</b>   |   |



The event log can retain up to 100,000 events before the oldest event is overwritten.

### 8.2.1 Filtering Events

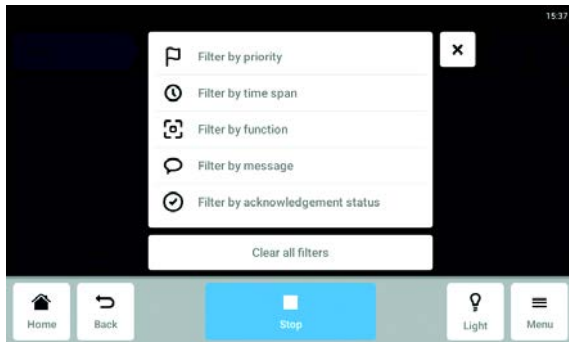

- ▶ Tap *Menu > Events*.
- ▶ Tap the Filter button.
- ▶ Select filters.  
 If a filter is enabled, a checkmark appears next to the filter.  
 In the *Events* window, the filter symbol is highlighted in blue.
- ▶ To disable all the filters, tap *Clear all filters*.

### 8.2.2 Editing Events

1. To edit a message, tap the line with the message.

The following parameters are displayed:

- Message number
  - Status
  - Date and time
  - User that was logged in at the time of the message.
  - Message text
  - Button to acknowledge the message
  - Symbols to call up corresponding parameters
2. To acknowledge a message, tap *Acknowledge*.  
 The button's appearance will change.
  3. To check the parameters of the message, tap the symbols to the right.

### 8.2.3 Exporting Events.

- ▶ Tap *Menu > Events*.
- ▶ Tap *Export* (see *Export* on p. 68).

## 8.3 Alarms

You can set alarms and alarm limits for the device.

The device has three alarms:

- Temperature alarm – Triggers if the temperature in the interior exceeds the alarm limits.
- Speed alarm – Triggers if the speed exceeds the alarm limits.
- Door alarm – Triggers if the outer door has been open for too long.

Tab. 8-1: The default factory settings for the alarms of the Innova S44i are as follows:

Alarm	Temperature	Speed	Door open
Default factory setting	+/- 0.5 K	+/- 5 rpm	5 min

### 8.3.1 Setting alarms and alarm limits

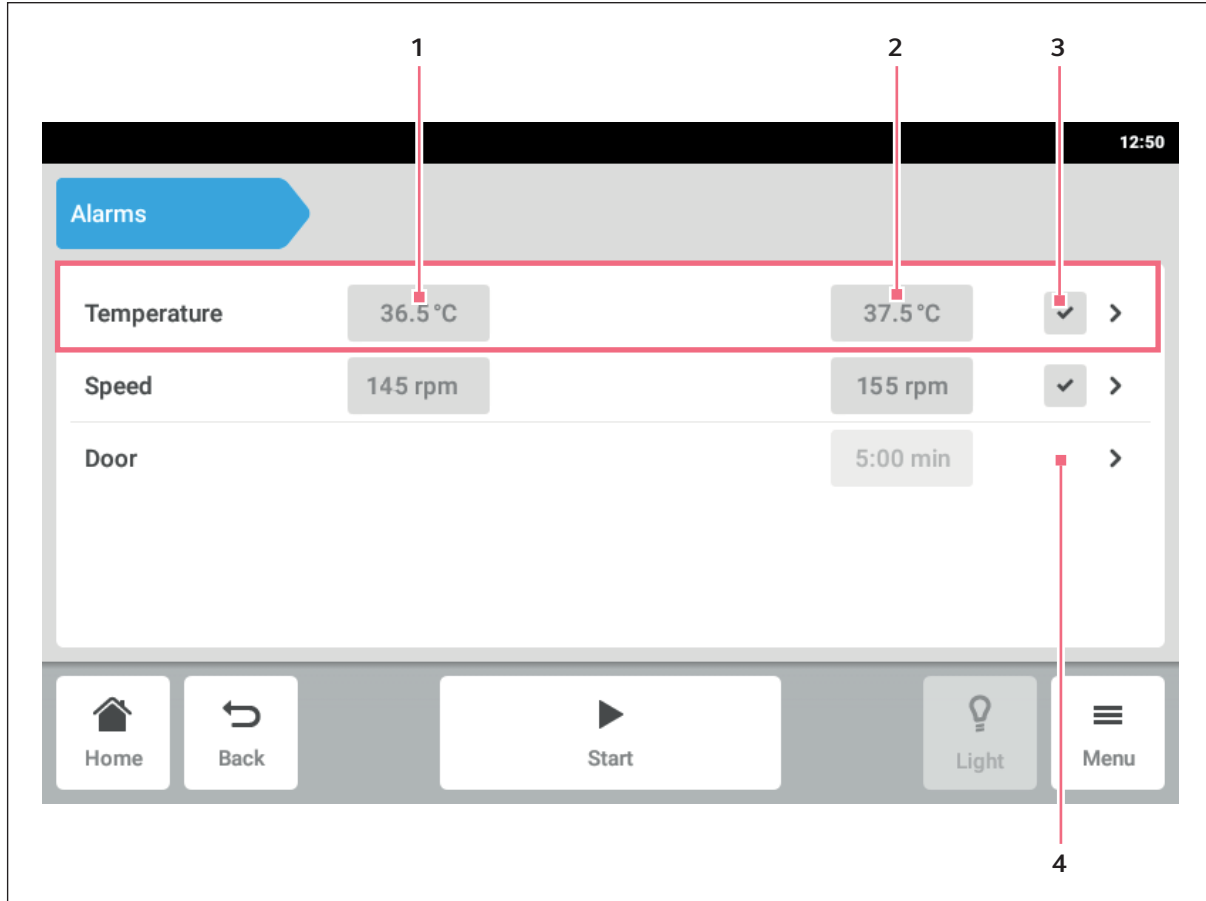

Fig. 8-4: The *Alarms* screen

**1 Lower alarm limit**

**3 Alarm activated**

**2 Upper alarm limit**

**4 Alarm not activated**

- To access the device alarm overview, tap the *Menu > Alarms* menu items.  
A window containing all of the device alarms, the warning limits, and the alarm limits appears.
- To open an alarm, tap the corresponding line.  
The overview window for this alarm appears.

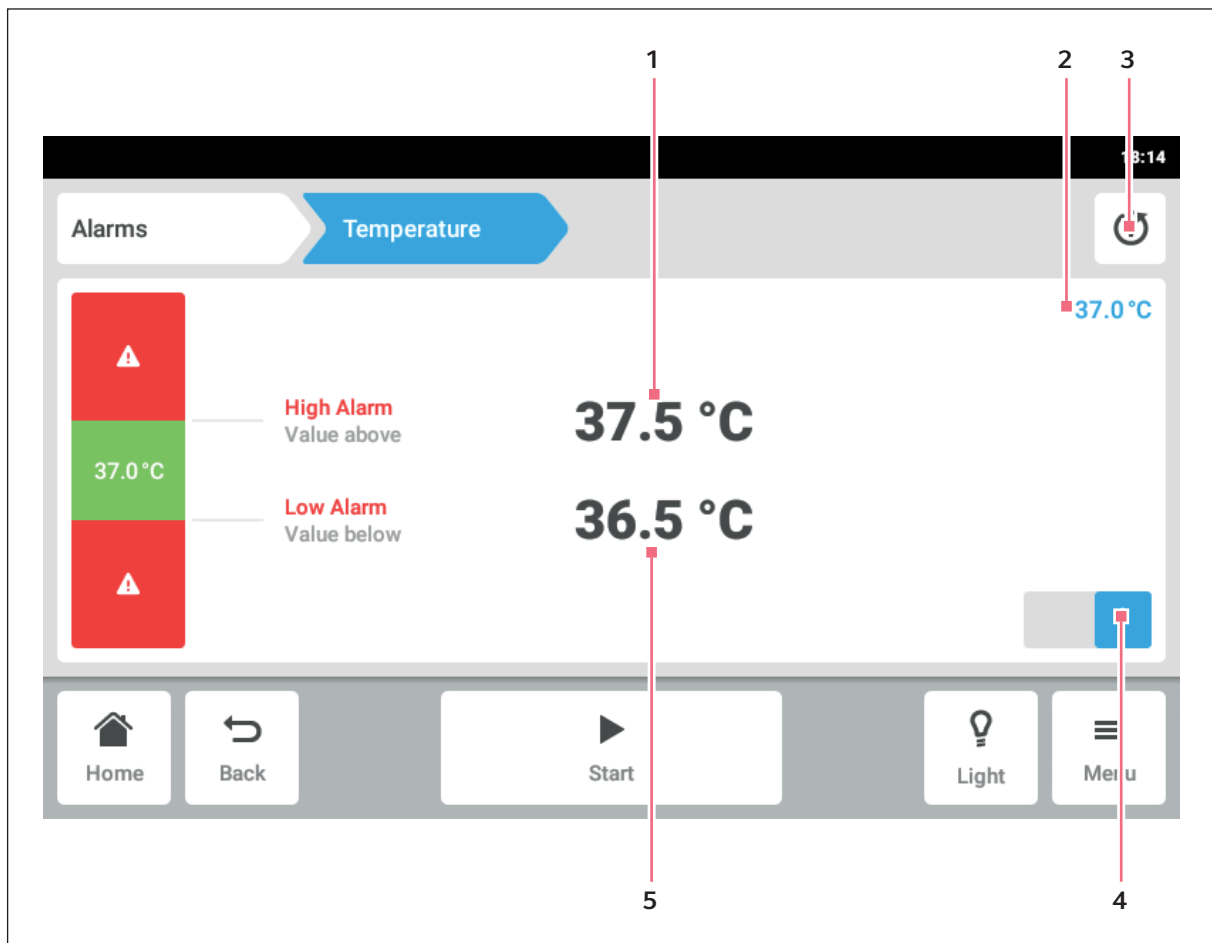
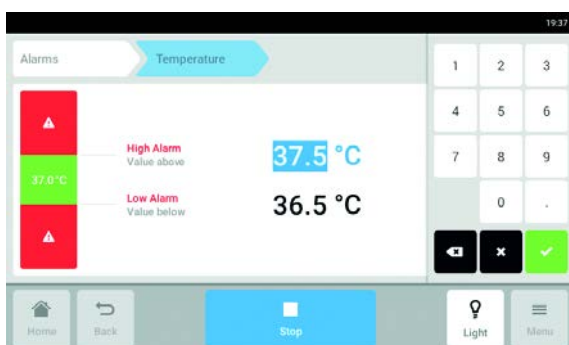

Fig. 8-5: Setting an alarm

- 1 Upper alarm limit
- 2 Actual value
- 3 Return to default setting
- 4 Activate or deactivate alarm
- 5 Lower alarm limit



- 3. To change an alarm limit, tap the alarm limit. The number pad appears.
- 4. Enter the new alarm limit.
- 5. Confirm your entry. The entered alarm limit appears on the touch screen.

## The Menu area

Innova® S44i  
English (EN)



If you change a set value, the alarm limits change accordingly.



If you want to reset the alarm to the factory defaults, tap the return to default setting button (see Fig. 8-5 on p. 61).

### 8.3.2 Active alarm

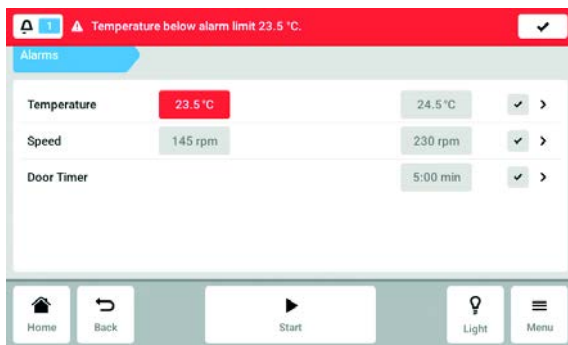

If an alarm is active, the exceeded alarm limit is highlighted in red in the alarm overview. The alarm appears in the information bar.

### 8.3.3 Setting the door alarm

The *Door* alarm can be set to trigger if the door is open for longer than: 30 s (seconds), 1 m (minutes), 2 m (minutes), 3 m (minutes), 5 m (minutes), or 10 m (minutes).

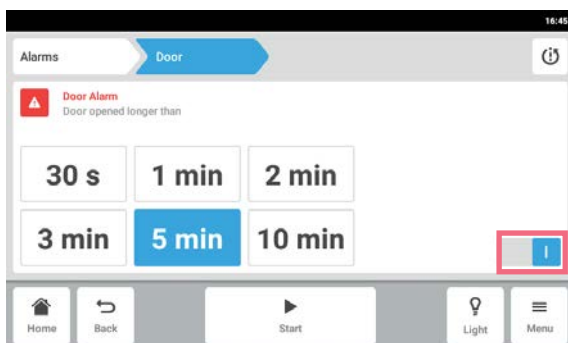

1. Tap the *Menu > Alarms > Door* menu items.
2. Activate or deactivate the alarm function.
3. Choose the alarm time.

### 8.3.4 Setting the speed alarm

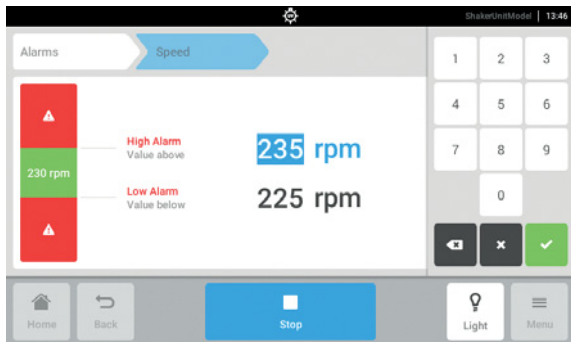

1. Tap the *Menu > Alarms > Speed* menu items.  
The speed high alarm and low alarm values appear.
2. Tap the displayed set values.  
The number pad appears.
3. Enter the desired set values with the number pad.
4. Confirm your entry.  
The number pad disappears.

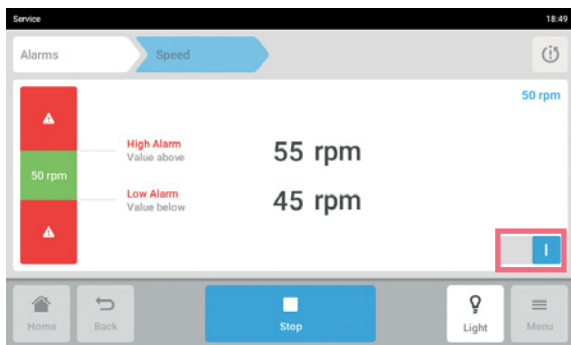

5. Activate or deactivate the speed alarm function.
6. To return to the home screen, tap the *Home* button.

### 8.3.5 Setting the temperature alarm

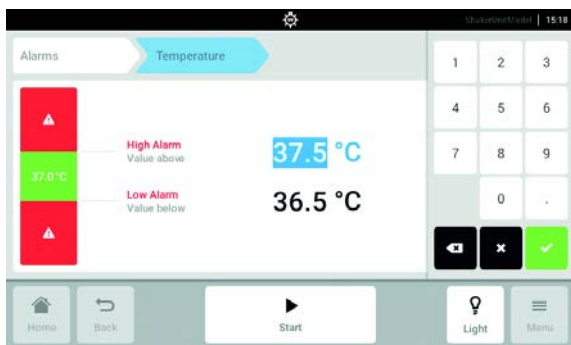

1. Tap the *Menu > Alarms > Temperature* menu items.  
The temperature high alarm and low alarm values appear.
2. Tap the displayed set values.  
The number pad appears.
3. Enter the desired set values with the number pad.
4. Confirm your entry.  
The number pad disappears.

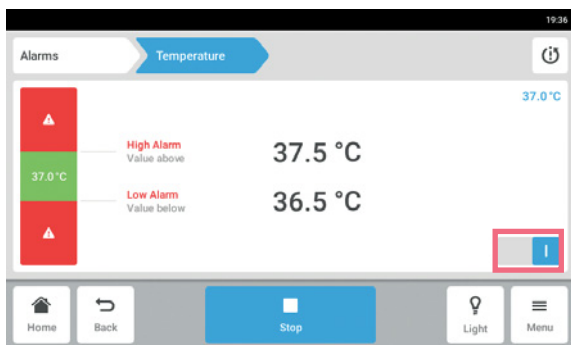

5. Activate or deactivate the temperature alarm function.

## 8.4 Contact and Support

Information on your Eppendorf partner can be entered in this area. can receive information on contacting the authorized service.

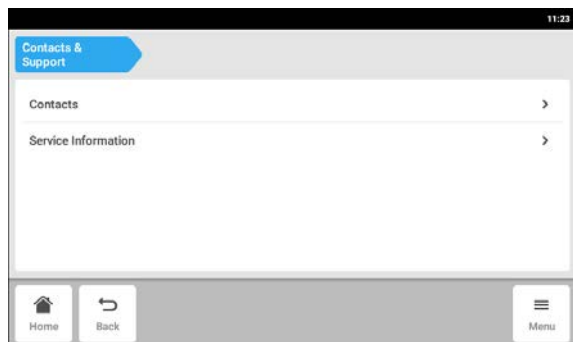

▶ Tap *Menu* > *Contact & Support*.

The following parameters are available:

- *Contacts*: Enter the addresses of the Eppendorf partners
- *Service Information*: Information on contacting the authorized service

### Contacts menu item – Entering contact partners

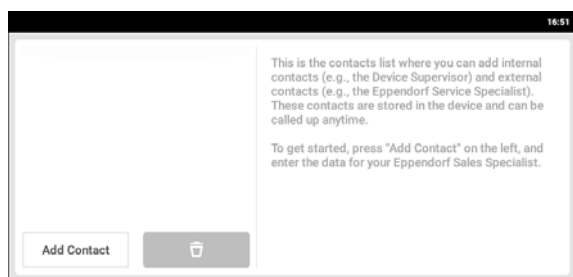

1. Tap *Menu* > *Contact & Support*.
2. Tap *Add Contact*.
3. Enter and confirm the name of the Eppendorf partner.

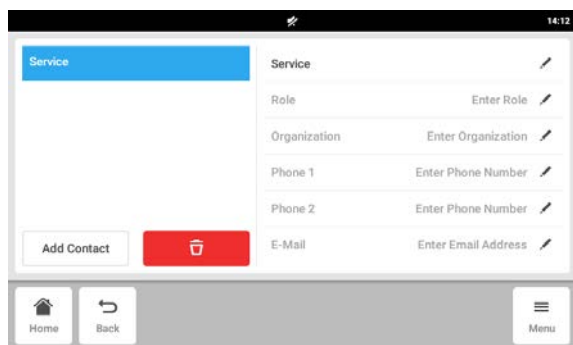

4. Enter the contact information of the Eppendorf partner.
5. To delete an entry, tap the recycle bin symbol.



## 8.5 Charts

Data is displayed in chart form in this area.

The chart has two different y-axes, each with a different scale. This allows it to show two functions. A function has the same color as the scale it has been assigned. The time is shown on the x-axis.



Fig. 8-6: The *Chart* screen

- 1 **Select the function.**  
The values of the selected function are displayed on the chart.
- 2 **Select the time span.**
- 3 **Name of the function for which values are displayed on the chart.**
- 4 **Export the chart data to a USB storage device.**

## The Menu area

Innova® S44i  
English (EN)

Tab. 8-2: The data storage duration is 112 days with a loss of resolution over time. Data is stored with following resolutions over time:

Age of sample	Interval for data storage (hh:mm:ss)
30 min	00:00:15
3 d	00:00:30
3 d 1 h	00:01:00
3 d 2 h	00:02:00
3 d 3 h	00:04:00
3 d 4 h	00:04:00
4 d	00:16:00
7 d	00:32:00
14 d	01:04:00
28 d	02:08:00
56 d	04:16:00
112 d	08:32:00



Changing the date and time settings during a program run, may interfere in the representation of chart histories.

### 8.5.1 Selecting functions

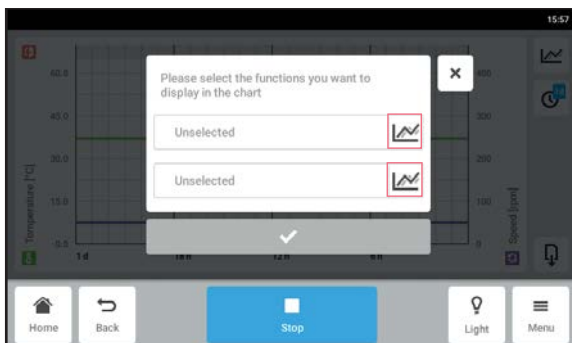

- ▶ Tap *Menu > Charts*.
  - ▶ Tap the Function button.
  - ▶ To select the functions for the left y-axis, tap the upper line.
  - ▶ To select the functions for the right y-axis, tap the lower line.
- A window with the available functions appears.

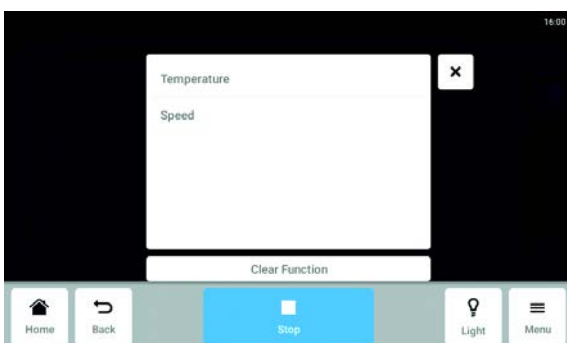

- ▶ Select the function.
- The function appears in the tapped line.

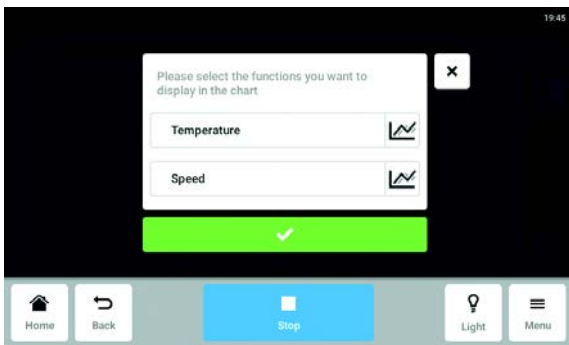

- ▶ Confirm your selection.  
 The function is displayed in the selected y-axis.

### 8.5.2 Selecting the time span

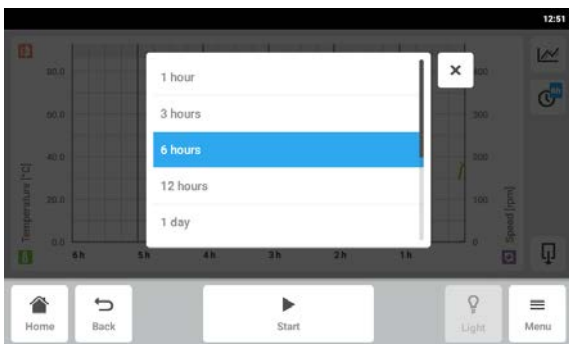

1. Tap *Menu > Charts*.
2. Tap the time span symbol.
3. Select the time span.  
 The time span appears on the x-axis.



Short door openings may not be visible in the chart due to the adjusted resolution. They are however visible in the Event log.

### 8.5.3 Displaying the chart's measured values



1. Tap *Menu > Charts*.
2. To display numerical measured values, select a defined time.
3. Tap the corresponding point in the chart.  
 The measured values of all functions are displayed.

### 8.5.4 Exporting charts

1. Tap *Menu > Charts*.
2. Connect a USB storage device.
3. Tap *Export*, to export chart data to a USB storage medium as .xlsx file.  
 The graphic itself will not be exported.



Short door openings may not be visible in the chart due to the adjusted resolution. They are however visible in the Event log.

## The Menu area

Innova® S44i  
English (EN)

### 8.6 Clean Screen

The touch screen can be locked to clean the touch screen.

#### Locking and unlocking the touch screen

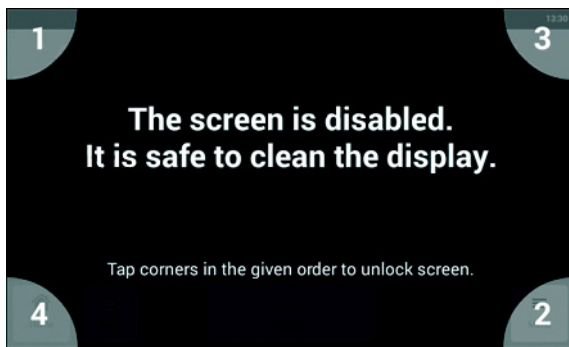

1. Tap *Menu > Clean Screen*.  
The touch screen is locked. During the display lock the shaker continues operating with its actual settings.
2. To unlock the touch screen, tap the numbered corners in their numerical sequence.  
The touch screen is unlocked. The previous screen is displayed.

### 8.7 Export

You can export all charts, events and system information for service to a USB storage device.

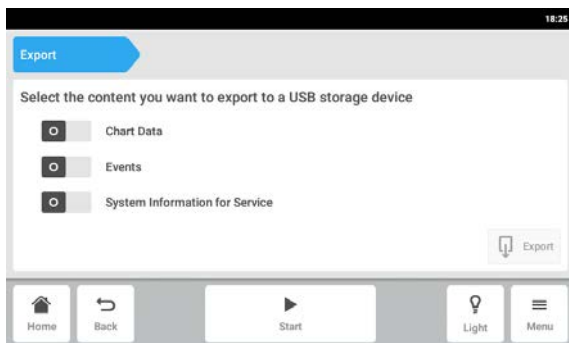

1. Connect a USB storage device.
2. Tap *Menu > Export*.
3. Use the sliders to select data for export.  
Data shown in gray will not be exported.
4. Tap *Export*.

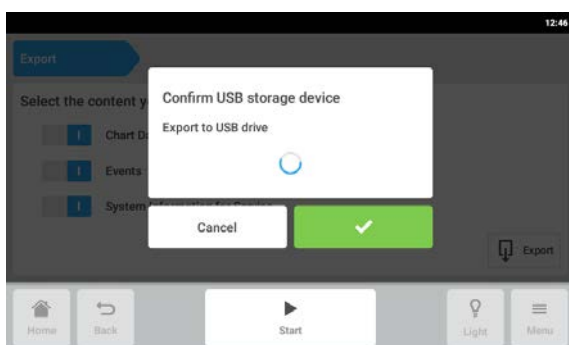

5. Confirm the connected USB storage device.

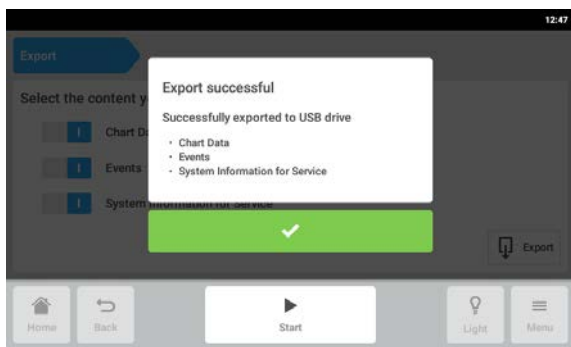

6. Confirm the export.
7. Remove the USB storage device.

## 8.8 Programs

Beside running the shaker continuously or in a simple timed mode, the program function allows the setting of user-defined multiple step programs. The parameters of a program step can be set and edited for temperature, speed, intensity of the photosynthetic light and time. There is also the option to loop single steps or a whole program. The Innova S44i can be set to run user-defined programs for an extended period of time.

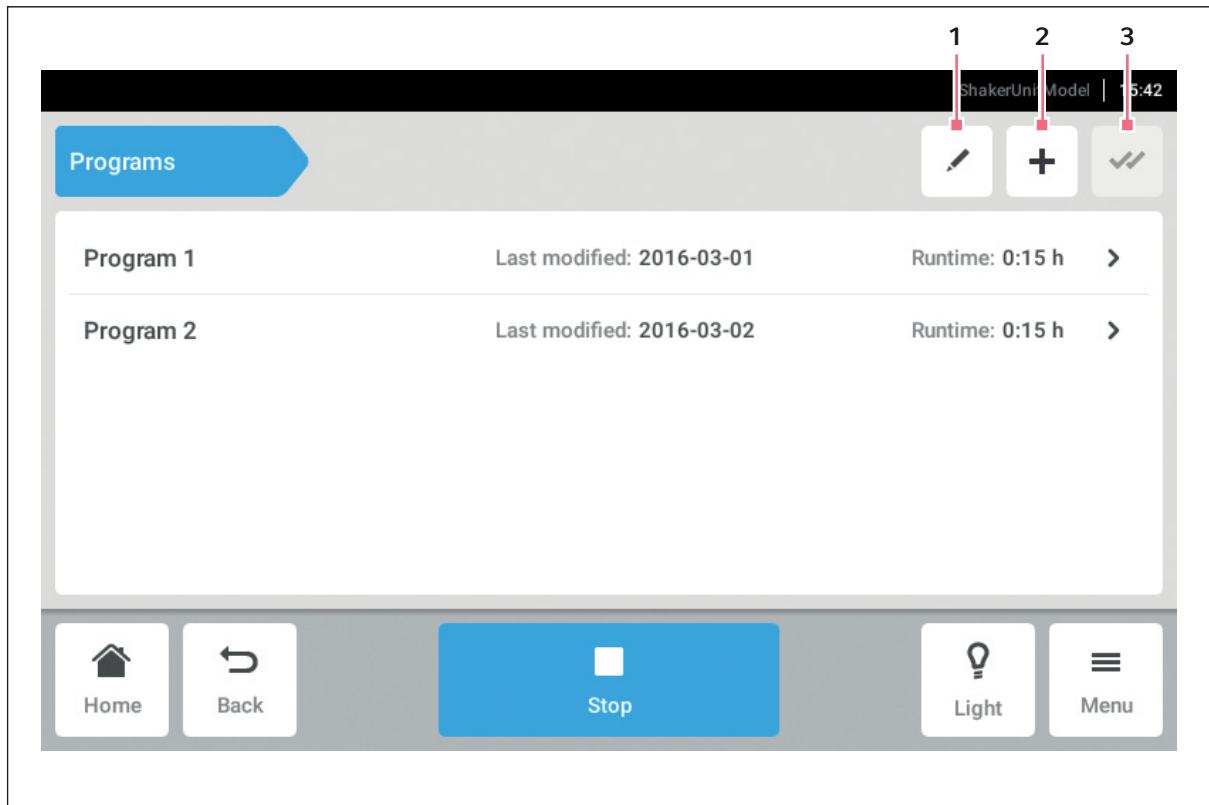

Fig. 8-7: The Program screen

**1 Edit program**

**3 Select all**

**2 Add program**

- ▶ Tap the *Menu > Programs* menu items.
- ▶ To navigate to the program details screen, tap a program.

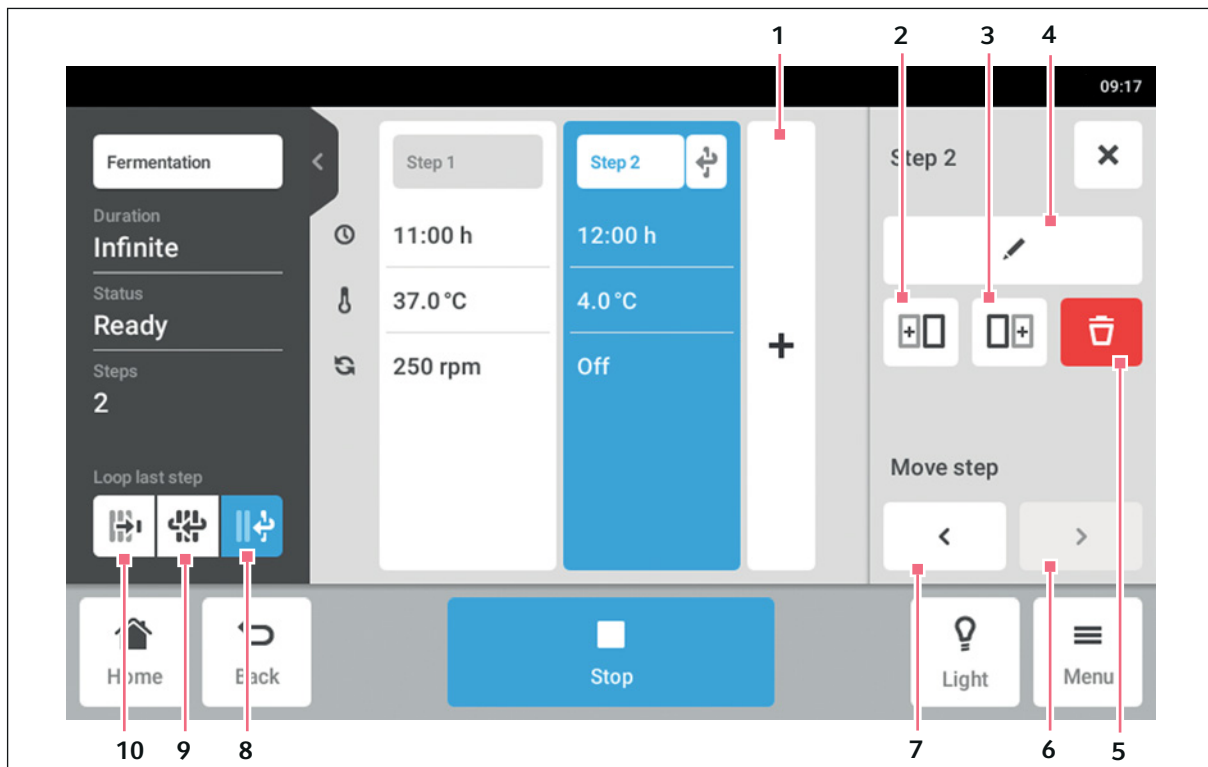

Fig. 8-8: The Program details screen

**1 Add step**

A step is added to the program. The step has all the parameters of the previous step.

**2 Insert copy before**

**3 Insert copy after**

**4 Edit step**

**5 Delete step**

**6 Move forward**

With the *Move forward* button it is possible to move single steps forward within a program.

**7 Move backward**

With the *Move backward* button it is possible to move single steps backward within a program.

**8 Loop last step**

The last step of a program is repeated in a loop.

**9 Loop program**

The program is repeated in a loop.

**10 Loop off**

Default setting for programs. The loop function is deactivated. The program ends with the last step.

## The Menu area

Innova® S44i  
English (EN)

### 8.8.1 Adding programs

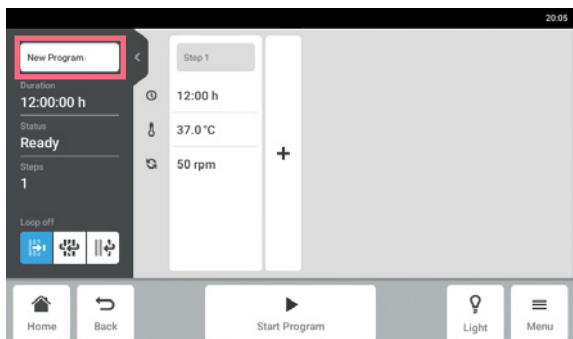

1. To add a new program, tap the *New program* button on the program screen.  
The program details screen appears.
2. To enter or edit the program name, tap the edit box.  
The touch keyboard appears.

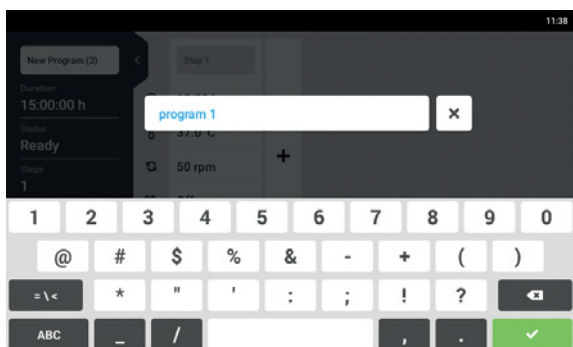

3. Enter the desired name.
4. Confirm your entry.  
The program details screen appears.

### 8.8.2 Editing programs

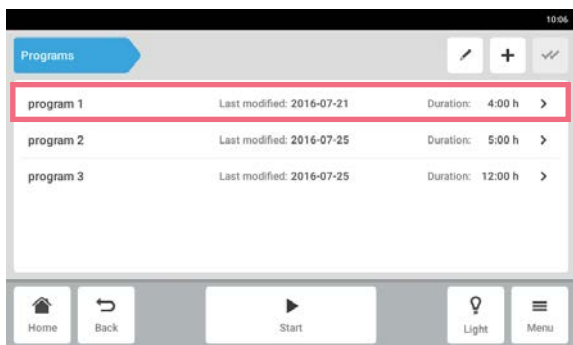

1. To edit a program, tap the program on the program screen.  
The program details screen appears.

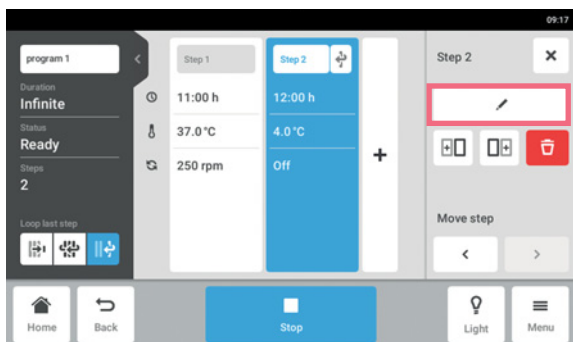

2. Tap the step you want to edit.  
The editing options for the step appear on the program details screen.
3. To change the parameters of a step, tap the *Edit step* button.





4. To edit a single parameter, tap the function in the list.
  5. Tap the displayed value.
  6. Enter the desired set value with the number pad.
  7. Confirm your entry.
- To return to the program details screen, tap the *Back* button.

**i** If you want to activate or deactivate a function of a step, proceed as follows:

- Tap the step you want to edit.
- Tap the *Edit step* button.
- Tap the function in the list.
- Activate or deactivate the function.

**i** To duplicate a step, you can also tap the *Add step* button on the program details screen.

### 8.8.3 Deleting or duplicating programs

**i** The *Options* button is only available in edit mode. To enter edit mode, tap the *Edit program* button.

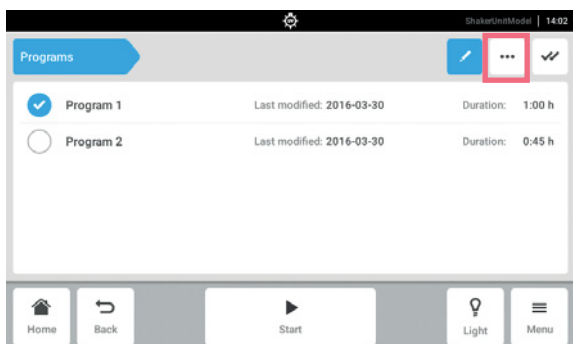

1. Tap the *Edit program* button.
  2. Select a program.
  3. Tap the *Options* button.
- The options *Duplicate* and *Delete* appear.

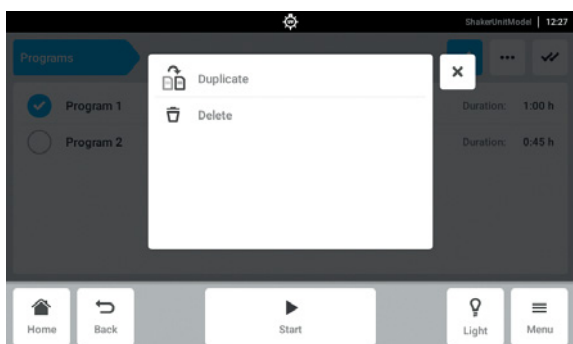

4. Tap the desired option.
  - If *Delete* is selected, confirmation is required.
  - If *Duplicate* is selected, the program screen appears.

**i** To duplicate a step, you can also tap the *Add step* button on the program details screen.

## 8.9 Login

User management is set up, and you can log in as a user or administrator (see p. 75).

### 8.9.1 Logging in and out as a user

Prerequisites

- User management is set up.

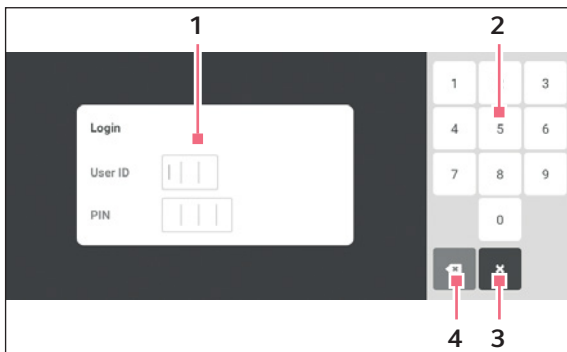

Fig. 8-9: The *Login* screen

**1 Edit box**

**2 Number pad**

**3 Abort login**

**4 Delete the entry step by step**

#### Logging in as a user

1. Tap the *Menu > Login* menu items.
2. Enter your user ID and your PIN or password.

If the correct PIN or password is entered, the user is automatically logged in.

#### Logging out as a user

1. Tap the *Menu > Logout* menu items.

## **9 User administration**

### **9.1 The user administration concept**

The user administration can be used to organize access to the Innova S44i. There are three user roles:

- Administrator
- User with standard rights
- User with restricted rights

#### **9.1.1 User roles for working with the user administration**

##### **Administrator**

The administrator has additional rights:

- Configuring Innova S44i
- Access to user administration

##### **User with standard rights**

- A user with standard rights can operate the Innova S44i without restrictions and create new programs and folders.

##### **User with restricted rights**

- A user with restricted rights can operate the Innova S44i with certain restrictions, i.e. select, start and stop existing programs.

##### **Logged out user**

- A logged out user can stop a program execution.

#### **9.1.2 Working without user administration**

Without user administration all users have the same rights as an administrator.

### 9.1.3 User rights

Tab. 9-1: User administration

Tasks	User with restricted rights	User with standard rights	Administrator/ Operator (rights without user administration)
Users button in <i>Menu</i>	x	x	x
User list and all users attributes			
Add user			x
Delete other user			x
Change own user name			
Change others' user name			
Change own full name	x	x	x
Change others' full name			x
Change own e-mail	x	x	x
Change others' e-mail			x
Change own user ID			x
Change others' user ID			x
Change own role			
Change others' role			x
Change own PIN/password	x	x	x
Reset others' PIN/password			x

Tab. 9-2: Common settings

Tasks	User with restricted rights	User with standard rights	Administrator/ Operator (rights without user administration)
Settings button in menu	x	x	x
About/Device			
About/Device/Name			x
About/License information			
About/Export	x	x	x
About/Export → System information for service	x	x	x
About/Export → All other entries	x	x	x
Device/Acoustic signals → Switch			x

Tasks	User with restricted rights	User with standard rights	Administrator/ Operator (rights without user administration)
Device/Acoustic signals -> Test button	x	x	x
Device/Display settings	x	x	x
System/Date and time			x
System/Network			x

Tab. 9-3: User management

Tasks	User with restricted rights	User with standard rights	Administrator/ Operator (rights without user administration)
User management access			x
User management/Disable user management			x
User management/Automatic logout			x
User management/Login mode			x
User management/Grant all users extra privileges			x
Change set value of functions	x	x	x
Agitation function control (start/stop )	x	x	x
Control for all other functions (start/stop )	x	x	x
Change offset parameters of functions		x	x
Change alarm parameters of functions		x	x
Balance Master calibration			x
Balance Master optimization	x	x	x

**User administration**

Innova® S44i  
English (EN)

Tab. 9-4: Device settings

<b>Tasks</b>	<b>User with restricted rights</b>	<b>User with standard rights</b>	<b>Administrator/ Operator (rights without user administration)</b>
Device Settings/Chamber light			×
Chamber light button in menu bar	×	×	×
Device settings/Home screen configuration			×

Tab. 9-5: Notification acknowledgement

<b>Tasks</b>	<b>User with restricted rights</b>	<b>User with standard rights</b>	<b>Administrator/ Operator (rights without user administration)</b>
Acknowledge alarm		×	×
Acknowledge error			×

Tab. 9-6: Product-specific feature (programming)

<b>Tasks</b>	<b>User with restricted rights</b>	<b>User with standard rights</b>	<b>Administrator/ Operator (rights without user administration)</b>
Access to <i>Menu &gt; Program</i>	×	×	×
Create new program		×	×
Duplicate program		×	×
Delete program		×	×

Tab. 9-7: Rights in program editor

<b>Tasks</b>	<b>User with restricted rights</b>	<b>User with standard rights</b>	<b>Administrator/ Operator (rights without user administration)</b>
Start program execution	×	×	×
Stop program execution	×	×	×

## 9.2 Defining settings in the user administration

### 9.2.1 Creating an administrator

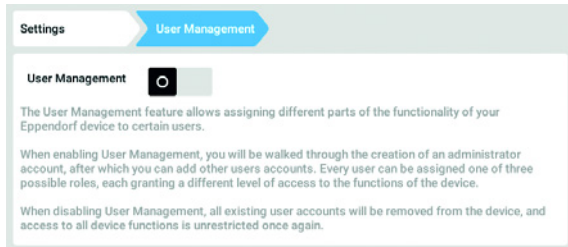

1. Tap the *Menu* button and navigate to the *Settings* > *User Management* menu item.
2. To activate the user administration, slide the *User Management* switch to the *I* position. The *Login mode* window appears.

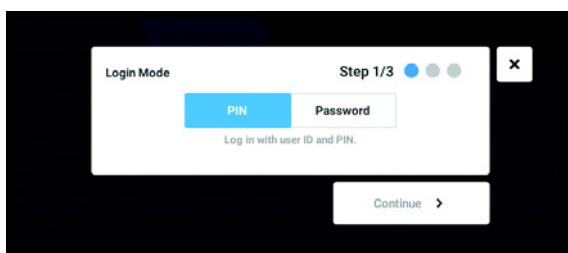

3. Define the login mode for all users.
4. Continue the process with *Continue*. The *Administrator credentials* window appears.

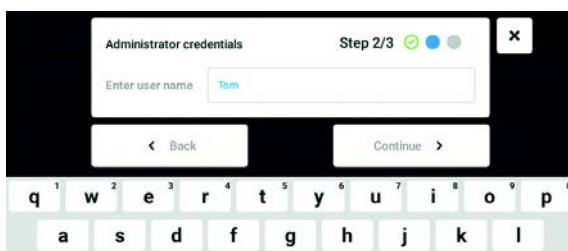

5. Enter the user name for the first administrator in the *Enter User Name* field.
6. Continue the process with *Continue*. The *Administrator credentials* window appears.

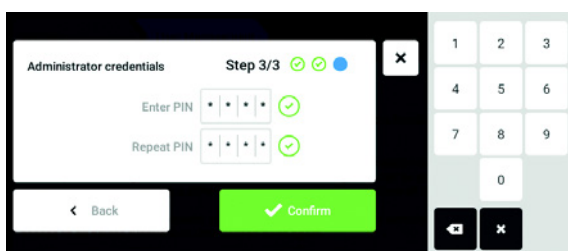

7. Enter PIN or password in the *Enter PIN/Password* field. Confirm the entry in the *Repeat PIN/Password* field.
8. Continue the process with *Continue*. The *User Management successfully enabled* window appears. The user administration is activated. The user account for the first administrator is created.

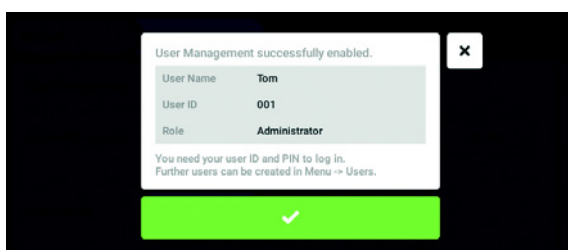

9. Confirm the message. The *User Management* window appears. It is now possible to edit the user administration.

## 9.2.2 Editing the user administration

### Prerequisites

- The administrator is logged in.

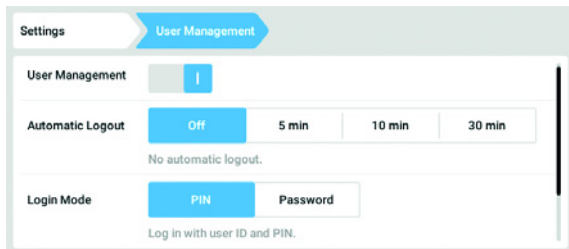

1. Tap the *Menu* button and navigate to the *Settings* > *User Management* menu item.

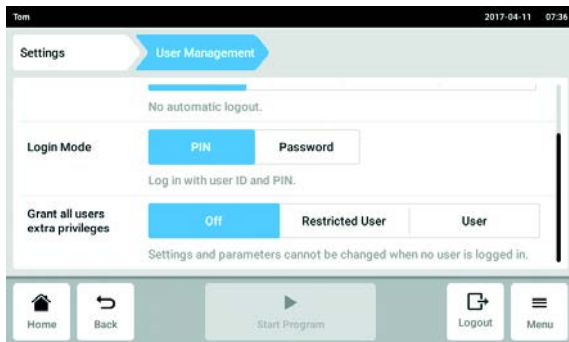

2. Define the settings for the user administration.

- *User Management*: Switch the user administration on and off.
- *Automatic Logout*: Define the time after which a user is automatically logged out if the touch screen is not used.
- *Login Mode*: Define the login mode for all users.
- *Grant all users extra privileges*: Restricted rights (*Restricted User*) or standard rights (*User*) are active for all users.



When the *Grant all users extra privileges* option is activated, a login is not necessary. Also, users who are not recorded in the user administration can operate the device with these rights (*Restricted User / User*).



### 9.2.3 Deactivating the user administration



#### NOTICE! Data loss in case of deactivation of the user administration

Deactivating the user administration deletes all user accounts.

- ▶ Check whether deactivation of the user administration is required.
- ▶ Inform all users that the user accounts have been deleted.

#### Prerequisites

- The administrator is logged in.

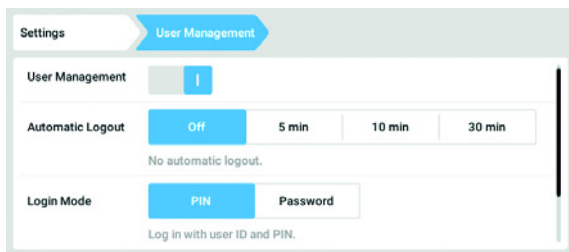

1. Tap the *Menu* button and navigate to the *Settings* > *User Management* menu item.
2. To deactivate the user administration, slide the *User Management* switch to the *Off* position. The *Disabling User Management* window appears.

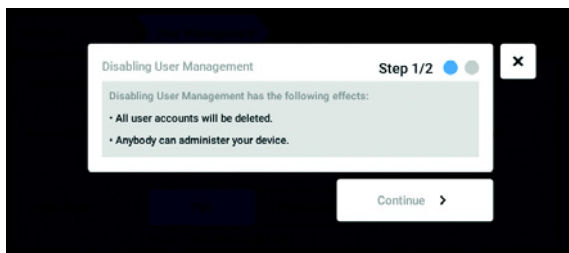

3. Continue the process with *Continue*. The *Confirm deleting all user accounts* window appears.

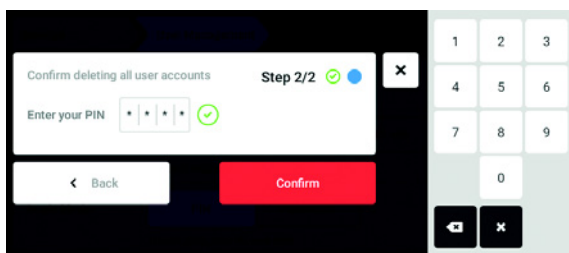

4. Enter the PIN/password.
5. Complete the process with *Continue*. The user administration is deactivated. All user accounts are deleted.

## 9.3 Editing user accounts as an administrator



### NOTICE! Data loss due to loss of the administrator password.

The administrator is able to change his password or his PIN only with his access data. If the administrator's access data is lost, it will not be possible to make changes to the user administration or to the system settings.

In this case, the device will have to be reset to the factory settings by an authorized service technician. All user accounts and any data and settings stored on the device will be deleted.

- ▶ Create a second user account with administrator rights.
- ▶ Keep the administrator password secure.

### 9.3.1 Creating a user account



You can create 999 user accounts.

#### Prerequisites

- The administrator is logged in.

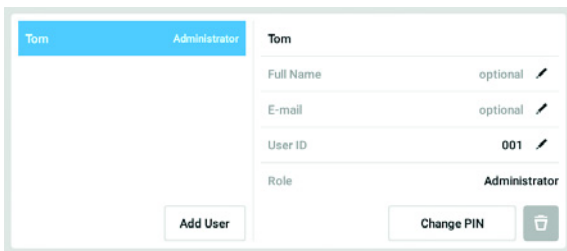

1. Tap the *Menu* button and navigate to the *User* menu item.  
The list with the user accounts is displayed.
2. Tap the *Add User* button.  
The *Enter User Name for the new user* field appears.

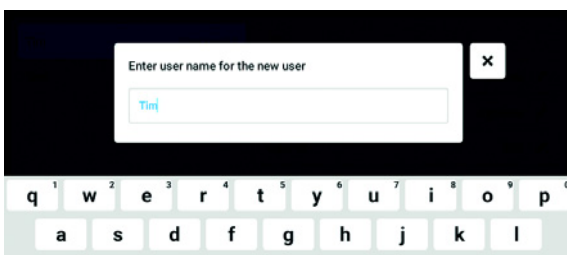

3. Enter the user name.
4. Confirm your entry.  
The *User credentials* window appears.  
The user account is created. The user data appears in the window.  
The user is assigned to the user group *Restricted User*.

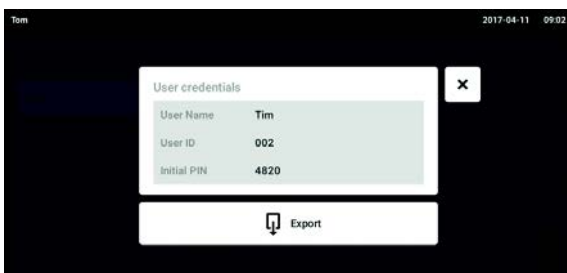

5. **Optional export of user data:** Connect the USB stick and tap the *Export* button.
6. Confirm the export.  
The user data is exported to the USB stick in a TXT file.
7. If the export is successful, the *Export successful* window appears.  
To complete the process, confirm the message.

### 9.3.2 Editing user accounts



Users with restricted user rights or standard rights can only edit their own *Full Name* and *E-mail* entries. Users can always change their own PIN or password. Administrators can assign a new user ID to a user account and change the rights.

#### Prerequisites

- The administrator is logged in.

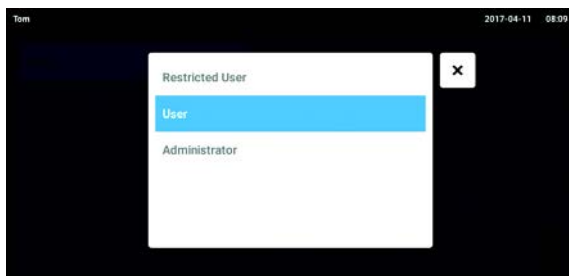
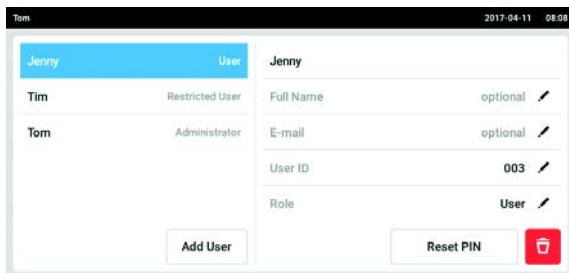

1. Tap the *Menu* button and navigate to the *User* menu item.  
The list with the user accounts appears. Entries that can be edited are indicated by a black pen.
2. Select the user account.
3. Optional: Enter the full name.
4. Optional: Enter the e-mail address.
5. To change the user ID, tap *User-ID*.
6. Select the new user ID.
7. To change the user group and the corresponding rights, tap *Role*.  
The list with the available user groups appears.
8. Assign a user group to the user.
  - Restricted User
  - User
  - Administrator

The selected parameters are stored and appear in the user account.

## User administration

Innova® S44i  
English (EN)

### 9.3.3 Deleting a user account

#### Prerequisites

- The administrator is logged in.

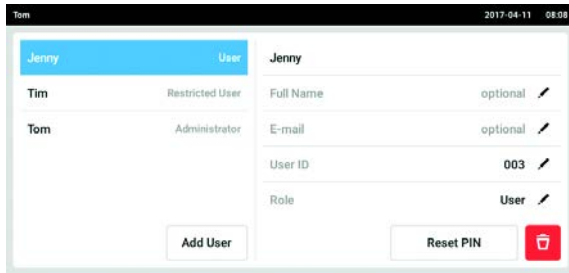

1. Tap the *Menu* button and navigate to the *User* menu item.  
The list with the user accounts appears.
2. Select the user account to be deleted.
3. Tap the *Recycle bin* symbol.  
The *Confirm the deletion of:* window appears.

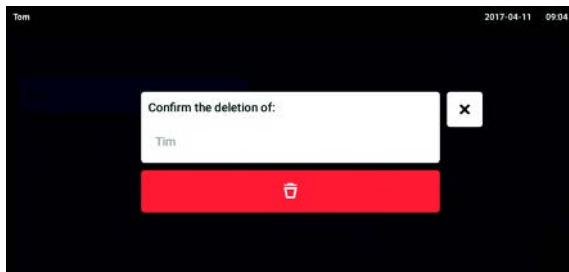

4. Confirm that you want to delete the user account.  
The user account is deleted.

### 9.3.4 Resetting the password/PIN for a user account

If a user has forgotten their password/PIN, the administrator can generate a new password.



The administrator can only change their password or PIN with their current access data. If the administrator's access data is lost, changes are no longer possible in the user administration. In this case, the device must be reset to the factory settings by an authorized service technician. All user accounts and the programs, log files and logs stored on the device will be deleted.

- ▶ Create a second user account with administrator rights.

#### Prerequisites

- The administrator is logged in.



1. Tap the *Menu* button and navigate to the *User* menu item.  
The list with the user accounts appears.
2. Select the user account.
3. Tap the *Reset Password/PIN* button.  
The *Do you want to reset the Password/PIN for:* window appears.

4. Confirm the process with *Reset*.  
The *New Credentials* window appears.  
The new password/PIN is created automatically.

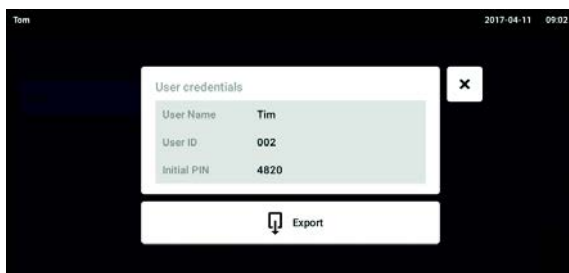

5. To export the user data, connect the USB stick and tap the *Export* button.
6. Confirm the export.  
The user data is exported to the USB stick in a TXT file.
7. If the export is successful, the *Export successful* window appears.  
To complete the process, confirm the message.

## 9.4 Administrating your own user account

Users can only edit their own *Full Name* and *E-mail* entries. Users can always change their own PIN or password.

### Prerequisites

- The user is logged in.

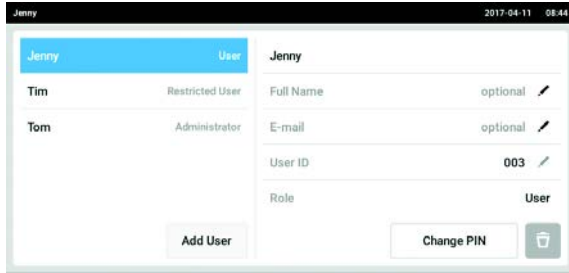

1. Tap the *Menu* button and navigate to the *User* menu item.  
The list with the user accounts appears. Entries indicated by a black pen can be edited.
2. Select the user account.
3. Optional: Enter the full name.
4. Optional: Enter the e-mail address.
5. To change the password/PIN, tap the *Change Password/PIN* button.
6. Enter the current password/PIN in the *Enter current Password/PIN* field.
7. Enter the new password/PIN in the *Enter new Password/PIN* and *Repeat new Password/PIN* fields.
8. Confirm your entry.  
The message *Password/PIN successfully changed* appears.  
The new password or the new PIN is active.

## 10 Maintenance

### 10.1 Service options

Eppendorf recommends having your device checked and maintained by trained specialist personnel at regular intervals.

Eppendorf offers you tailor-made service solutions for the preventive maintenance, qualification and calibration of your device. For information, offers and contact options, please visit [www.eppendorf.com/epservices](http://www.eppendorf.com/epservices).

### 10.2 Cleaning/decontamination

---



#### **DANGER! Electric shock.**

- ▶ Switch off the device and disconnect the mains/power plug before commencing any service or cleaning procedures.
- 



#### **WARNING! Danger due to contact with decontamination agent**

- ▶ Wear protective equipment, gloves, and protective goggles during the cleaning process.
  - ▶ Wear respiratory protection when aerosolization is suspected.
- 



#### **NOTICE! Damage to device due to liquid spills.**

- ▶ Switch off the device.
  - ▶ Disconnect the mains/power plug.
  - ▶ Collect the spilled liquid. Observe the information in the Safety Data Sheet for the liquid.
- 



#### **NOTICE! Damage due to aggressive cleaning agent or sharp objects**

Incorrect cleaning agents can damage the display, surfaces, and printing.

- ▶ Do not use corrosive cleaning agents, aggressive solvents, or abrasive polishes.
  - ▶ Do not incubate the accessories in aggressive cleaning agents or disinfectants for an extended period of time.
  - ▶ Do not use sharp objects to clean the device.
-

### 10.2.1 Routine cleaning

To maintain the functionality and appearance of the device, clean the device regularly.

Auxiliary equipment

- Lint-free cloth
- Laboratory cleaner

Prerequisites

- The device is switched off and disconnected from the mains/power supply.
1. To ensure proper air flow in and around the device, remove dust and dirt near the device.
  2. Remove the interchangeable platform.
  3. To clean the device, wipe over the following components with a lint-free cloth moistened with laboratory cleaner:
    - External surfaces
    - Internal surfaces
    - Interchangeable platform
  4. Reinstall the interchangeable platform.

### 10.2.2 Wipe decontamination



#### **NOTICE! Risk of material damage**

Other methods of decontamination than those specified by the manufacturer may damage the device.

- ▶ Use the decontamination methods specified by the manufacturer.
  - ▶ For further questions regarding the disinfection of the device, contact Eppendorf support.
- 

Auxiliary equipment

- Lint-free cloth
- 70 % ethanol, 70 % Isopropanol 1 % sodium hypochlorite solution or other suitable disinfectant (e.g., Dismozon pur, Hexaquart S, Biocidal ZF)

Prerequisites

- The device is switched off and disconnected from the mains/power supply.
1. Remove the interchangeable platform.
  2. To decontaminate the device, wipe over the following components with a lint-free cloth moistened with a suitable disinfectant:
    - External surfaces
    - Internal surfaces
    - Interchangeable platform
  3. Reinstall the interchangeable platform.



### 10.2.3 Wipe decontamination of the touch screen

Auxiliary equipment

- Lint-free cloth
- Laboratory cleaner
- Distilled water
- 70 % ethanol, 1 % sodium hypochlorite solution or other suitable disinfectant (e.g., Dismozon pur, Hexaquart S, Biocidal ZF)

1. To clean or decontaminate the touch screen of the Innova S44i, lock the touch screen (see *Clean Screen on p. 68*).
2. Wipe over the touch screen with a lint-free cloth moistened with laboratory cleaner or a suitable disinfectant.
3. Remove residues of the disinfectant with a lint-free cloth moistened with distilled water.
4. Unlock the touch screen.

### 10.2.4 Decontamination of the chamber bottom cover after spills

The bottom of the chamber is protected by a cover which catches spills. The bottom cover can be flushed for decontamination. The maximum filling volume is 3 L.



**NOTICE! Risk of material damage**

Incorrect removal of the sub-platform may damage the device.

- ▶ If the drive or chamber bottom must be accessed after severe spills, contact an authorized Eppendorf service center.

Prerequisites

- The device is switched off and disconnected from the mains/power supply.

Auxiliary equipment

- Distilled water
- 1 % sodium hypochlorite solution or other suitable disinfectant

1. Place a sufficiently large container ( $\geq 3$  L) below the refrigeration drain on the right-hand side of the device.
2. Connect the supplied drain tubing to the refrigeration drain on the right side of the device. Make sure to place the end of the drain tubing into the container.
3. Flush carefully from the front with a maximum of 2 L of disinfection solution.
4. Allow the solution to drain completely.
5. To remove residues, flush 3 × with 3 L of distilled water.  
Allow the flush water to drain.
6. Disconnect the drain tubing after decontamination.



To drain liquid properly from a device installed on a small base, shorten the drain tubing or use a vacuum pump.

### 10.3 Service intervals

<b>Component</b>	<b>Service interval</b>
Temperature sensor accuracy	12 months
Drive belt inspection	12 months

The maintenance of the components must be performed by an authorized service technician. Contact your local Eppendorf partner. The contact addresses can be found online at [www.eppendorf.com/worldwide](http://www.eppendorf.com/worldwide).

## 11 Troubleshooting

If you cannot remedy an error with the recommended measures, please contact your local Eppendorf partner. The contact address can be found on the Internet at [www.eppendorf.com](http://www.eppendorf.com).

<b>Problem</b>	<b>Cause</b>	<b>Solution</b>
The shaker does not run.	• Door open	▶ Close door firmly, making sure latch is engaged.
	• Fuses burned out	▶ Call an authorized service partner.
	• Mains/power switch not working • Door switch defective	▶ Call an authorized service partner.
The shaker does not run at the set speed.	• Shaker overloaded	▶ Remove some contents and balance the load.
	• Shaker out of balance	▶ Run Balance Master optimization. ▶ Adjust the counterweight.
Actual values are not indicated on the touch screen.	• Device not properly calibrated	▶ Call an authorized service partner.
Temperature control loop error	• Device not well-sealed due to issue with door, gasket, latches, ports/plugs	▶ Check the door gasket for any blockage/ interference. ▶ Ensure that the access port plug is inserted and is properly seated.
The shaker stops and a visual and audible alarm is triggered.	• A fatal error	1. Mute the alarm. 2. Do not start the device. Call an authorized service partner.
Balance Master calibration unsuccessful.	• Vertical movement of base • Unstable base installation	▶ Locate the corner which shows movement. ▶ Shim the corner until the device is stable.
	• Floor conditions	▶ Move the device to an area with a stable floor. ▶ Set counterweight position according to the optimal counterweight setting table (see <i>Counterweight on p. 99</i> ).
	• Base unstable	▶ Locate the corner which shows movement. ▶ Shim the corner until the device is stable.



## 12 Transport, storage and disposal

### 12.1 Transport



**CAUTION! Risk of injury due to lifting and carrying heavy loads.**

The device is heavy. Lifting and carrying the device can lead to back injuries.

- ▶ Transport and lift the device with an adequate number of helpers.
- ▶ Use a transport aid to transport the device.

- ▶ Use the original packaging and the transport securing devices for transport.

	Air temperature	Relative humidity	Atmospheric pressure
General transport	-25 °C – 55 °C	10 % – 95 %, non-condensing	0.7 bar (70 kPa) – 1.06 bar (106 kPa)
Air freight	-25 °C – 55 °C	10 % – 95 %, non-condensing	0.7 bar (70 kPa) – 1.06 bar (106 kPa)

### 12.2 Shipping the device



**WARNING! Risk of personal injury due to contamination.**

People may become contaminated if you store or ship a contaminated device.

- ▶ Clean and decontaminate the device before shipping or storage.



**NOTICE! Risk of damage due to improper packaging.**

Eppendorf AG is not liable for any damage caused by improper packaging.

- ▶ Only store and transport the device in its original packaging.
- ▶ If you do not have the original packaging, request original packing from Eppendorf AG.

#### Prerequisites

- The device has been cleaned and decontaminated.
- The original packaging is available.

1. Download the "Decontamination declaration for product returns" from [www.eppendorf.com](http://www.eppendorf.com).
2. Complete the decontamination declaration.
3. Pack the device.
4. Put the decontamination declaration into the packaging.  
Deliveries shipped without a decontamination certificate will not be processed.
5. Send the device to Eppendorf AG or an authorized service center.

### 12.3 Storage

	Air temperature	Relative humidity	Atmospheric pressure
In transport packing	-25 °C – 55 °C	10 % – 95 %, non-condensing	0.7 bar (70 kPa) – 1.06 bar (106 kPa)
Without transport packing	-25 °C – 55 °C	10 % – 95 %, non-condensing	0.7 bar (70 kPa) – 1.06 bar (106 kPa)

### 12.4 Disposal

Observe the relevant legal regulations when disposing of the product.

#### Information on the disposal of electrical and electronic devices in the European Community:

Within the European Community, the disposal of electrical devices is regulated by national regulations based on EU Directive 2012/19/EU pertaining to waste electrical and electronic equipment (WEEE).

According to these regulations, any devices supplied after August 13, 2005, in the business-to-business sphere, to which this product is assigned, may no longer be disposed of in municipal or domestic waste. They are marked with the following symbol to indicate this:



As the disposal regulations may differ from one country to another within the EU, please contact your supplier for more information.

## 13 Technical data

### 13.1 Power supply

	Innova S44i incubated	Innova S44i incubated/refrigerated
Mains/power supply voltage	100 V ±10 %, 50 Hz/60 Hz 120 V ±10 %, 50 Hz/60 Hz 230 V ±10 %, 50 Hz/60 Hz	
Fuse	10 A	
Power consumption	1800 W	
Overvoltage category	II	
Degree of pollution	2	
Protection class according to IEC 61010-1	I	
Specifications for mains/ power cord	AC 250/16A 3G 1.5 mm <sup>2</sup> appliance coupler C19 according IEC 60320-1	

### 13.2 Ambient conditions

Environment	For indoor use only
Ambient temperature	10 °C – 35 °C
Relative humidity	20 % – 80 %, non-condensing
Atmospheric pressure	79.5 kPa – 106 kPa Use up to a height of 2 000 m above sea level.

### 13.3 Noise level

Noise level	Innova S44i
	< 70 dB (A)

**Technical data**

Innova® S44i  
English (EN)

**13.4 Weight/dimensions****13.4.1 Device**

Device	Innova S44i incubated	Innova S44i incubated/ refrigerated
Weight	181.4 kg (400 lb)	188.2 kg (415 lb)
<b>Outer dimensions of device</b>		
Width	118.2 cm (46.5 in)	
Depth	86.9 cm (34.2 in)	
Height	63.1 cm (24.8 in)	
<b>Interior dimensions</b>		
Width	89.6 cm (35.3 in)	
Depth	71.9 cm (28.3 in)	
Height chamber bottom to chamber ceiling	57.5 cm (22.6 in)	
Height platform to chamber ceiling	43.7 cm (17.2 in)	
Height platform to photosynthetic light bank	40.6 cm (16.0 in)	
Height platform to incubation shelf	27.0 cm (10.6 in)	
Height incubation shelf to chamber ceiling	15.0 cm (5.9 in)	

**13.4.2 Base**

Base	Short base	Tall base
Weight	16.8 kg (37.0 lb)	37.7 kg (83.0 lb)
Width	118.2 cm (46.5 in)	
Depth	73.7 cm (29.0 in)	
Depth with spacers	83.8 cm (33.0 in)	
Height	10.5 cm (4.1 in)	30.7 cm (12.1 in)

**13.4.3 Platform**

<b>Platform</b>	
Weight	10.0 kg (22.0 lb)
Width	76.2 cm (30.0 in)
Depth	62.0 cm (24.4 in)
Height	0.8 cm (0.3 in)



### 13.5 Material

	Material
Device	Outer housing: Powder coated carbon steel Chamber: Powder coated stainless steel Chamber bottom: ABS polycarbonate blend Door metal panel: Powder coated stainless steel Door window: Double-pane thermal glass
Base	Cast aluminum with polyester powder coating
Platform	Aluminum, anodized

### 13.6 Stacking dimensions

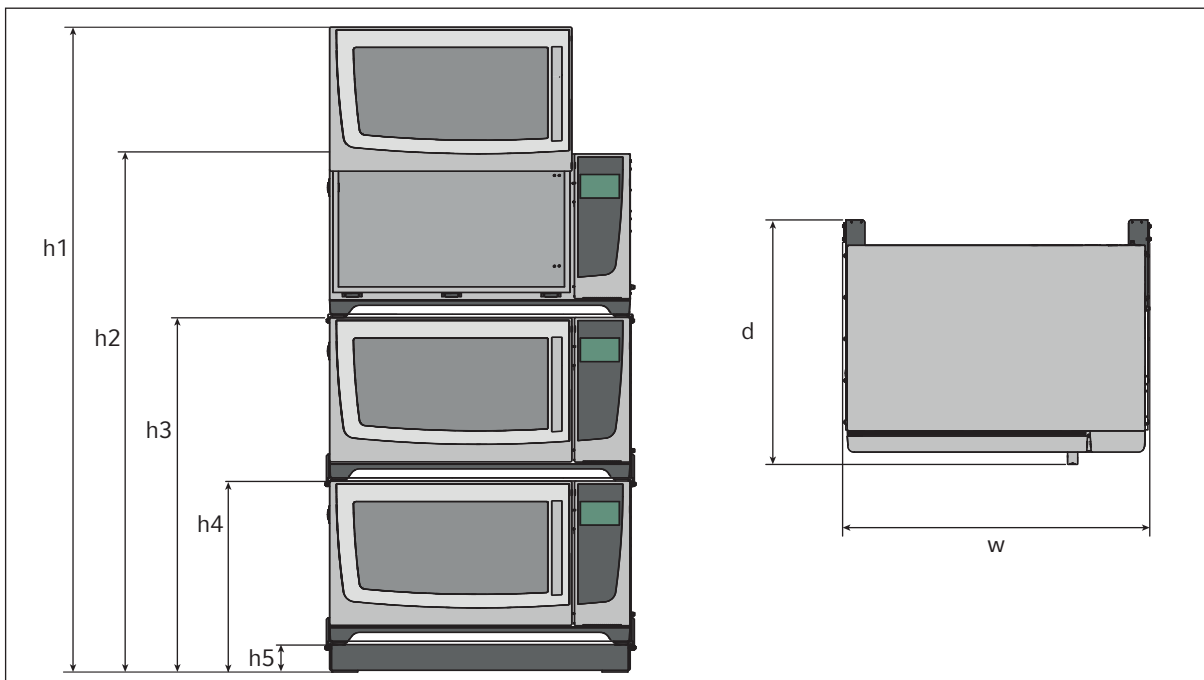

Fig. 13-1: Stacking dimensions with short positioning base

Height					Depth	Width
h1	h2	h3	h4	h5	d	w
254.5 cm (100.2 in)	203.7 cm (80.2 in)	139.4 cm (54.9 in)	73.6 cm (29.0 in)	10.5 cm (4.1 in)	95.8 cm (37.7 in)	118.2 cm (46.5 in)

**Technical data**

Innova® S44i  
English (EN)

**13.7 Interfaces**

USB	USB 2.0
Ethernet	Ethernet 100 MBit/s Exclusively for the connection to VisioNize Lab Suite

**13.8 Application parameters**

The following specifications assume a maximum load of 45.5 kg (100 lb), including platforms, clamps, glassware and contents.

**13.8.1 Agitation**

	<b>Orbit 2.5 cm (1 in)</b>	<b>Orbit 5.1 cm (2 in)</b>
Speed	20 rpm – 400 rpm	20 rpm – 300 rpm
	The speed can be set in increments of 1 rpm	
Control accuracy	±0.5 rpm	
Innova S44i stacked on Innova 44/44R	2 devices stacked: 20 rpm – 300 rpm 3 devices stacked: 20 rpm – 250 rpm	

**13.8.2 Load**

	<b>Orbit 2.5 cm (1 in)</b>	<b>Orbit 5.1 cm (2 in)</b>
Maximum load (including platform, clamps, glassware and contents)	45.5 kg (100 lb)	
Maximum platform load	35.4 kg (78 lb)	

**13.8.3 Temperature**

<b>Temperature</b>	<b>Innova S44i incubated</b>	<b>Innova S44i incubated/ refrigerated</b>
Minimum	10 °C above ambient temperature	20 °C below ambient temperature (minimum 4 °C)
Maximum	80 °C	
Control accuracy	±0.1 °C at 37 °C, ± 0.5 °C over the entire temperature range	
Uniformity	±0.25 °C at 37 °C and 150 rpm	
Indication	Displayed in increments of 0.1 °C	

### 13.8.4 Photosynthetic light

Main wave length	Wideband spectrum 400 nm – 700 nm
Light source	LED
Intensity range	15 PAR – 150 PAR
Uniformity	±10%
Indication	Displayed in increments of 5 %
Setting range	10 – 100 %
Output	150 W
Voltage	48 VDC

## 13.9 Counterweight

### 13.9.1 Counterweight settings for Balance Master calibration

Counterweight settings for Balance Master calibration of single and stacked devices

Position of device in stacked configuration	Orbit	Counterweight setting
Single	2.5 cm (1 in)	8.5
	5.1 cm (2 in)	17.0
Bottom of double	2.5 cm (1 in)	14.0
	5.1 cm (2 in)	19.5
Top of double	2.5 cm(1 in)	5.0
	5.1 cm (2 in)	10.5
Bottom of triple	2.5 cm (1 in)	13.5
	5.1 cm (2 in)	19.5
Middle of triple	2.5 cm (1 in)	6.5
	5.1 cm (2 in)	11.5
Top of triple	2.5 cm (1 in)	3.0
	5.1 cm (2 in)	7.0

**Technical data**

Innova® S44i  
English (EN)

**13.9.2 Optimal counterweight settings**

The following table indicates optimal counterweight settings depending on the load.

Tab. 13-1: Counterweight settings for devices with a 2.5 cm (1 in) orbit

<b>Optimal counterweight setting</b>	<b>Load in kg</b>	<b>Load in lb</b>
2.0	-	-
2.5	3.0	6.7
3.0	6.1	13.6
3.5	9.3	20.4
4.0	12.4	27.3
4.5	15.5	34.1
5.0	18.6	40.9
5.5	21.7	47.8
6.0	24.8	54.6
6.5	27.9	61.5
7.0	31.0	68.3
7.5	34.1	75.1
8.0	37.2	81.9
8.5	40.3	89.6
9.0	43.4	95.6

Tab. 13-2: Counterweight settings for devices with a 5.1 cm (2 in) orbit

Optimal counterweight setting	Load in kg	Load in lb
7.0	3.7	8.1
7.5	5.2	11.5
8.0	6.8	14.9
8.5	8.3	18.4
9.0	9.9	21.8
9.5	11.4	25.2
10.0	13.0	28.6
10.5	14.5	32.0
11.0	16.0	35.4
11.5	17.6	38.8
12.0	19.1	42.2
12.5	20.7	45.6
13.0	22.2	49.0
13.5	23.8	52.4
14.0	25.3	55.8
14.5	26.8	59.1
15.0	28.4	62.5
15.5	29.9	65.9
16.0	31.4	69.3
16.5	33.0	72.7
17.0	34.5	76.0
17.5	36.0	79.4
18.0	37.5	82.8
18.5	39.1	86.1
19.0	40.6	89.5
19.5	42.1	92.8
20.0	43.6	96.2

**Technical data**

Innova® S44i  
English (EN)

## 14 Ordering Information

### 14.1 Devices

#### 230V 50/60 Hz

Order no. (International)	Description
	<b>Innova S44i</b>
	230 V, 50 Hz/60 Hz
S44I300001	Orbit 2.5 cm (1 in), incubated
S44I310001	Orbit 2.5 cm (1 in), refrigerated
S44I311001	Orbit 2.5 cm (1 in), refrigerated, photosynthetic LED light bank
S44I320001	Orbit 5.1 cm (2 in), incubated
S44I330001	Orbit 5.1 cm (2 in), refrigerated
S44I331001	Orbit 5.1 cm (2 in), refrigerated, photosynthetic LED light bank

#### 120V 50/60 Hz

Order no. (International)	Description
	<b>Innova S44i</b>
	120 V, 50 Hz/60 Hz
S44I200005	Orbit 2.5 cm (1 in), incubated
S44I210005	Orbit 2.5 cm (1 in), refrigerated
S44I211005	Orbit 2.5 cm (1 in), refrigerated, photosynthetic LED light bank
S44I220005	Orbit 5.1 cm (2 in), incubated
S44I230005	Orbit 5.1 cm (2 in), refrigerated
S44I231005	Orbit 5.1 cm (2 in), refrigerated, photosynthetic LED light bank

#### 100V 50/60 Hz

Order no. (International)	Description
	<b>Innova S44i</b>
	100 V, 50 Hz/60 Hz
S44I000006	Orbit 2.5 cm (1 in), incubated
S44I010006	Orbit 2.5 cm (1 in), refrigerated
S44I020006	Orbit 5.1 cm (2 in), incubated
S44I030006	Orbit 5.1 cm (2 in), refrigerated

**Ordering Information**

Innova® S44i  
English (EN)

**14.2 Accessories**

<b>Order no. (International)</b>	<b>Description</b>
S44I041001	<b>Positioning base</b> Innova S44i 10.16 cm (4 in)
S44I041002	<b>Positioning Base</b> Innova S44i 30.48 cm (12 in)
S44I040001	<b>Universal platform</b> Innova S44i
S44I042001	<b>Static incubation shelf</b> Innova S44i
S44I042002	<b>Darkening window shade</b> Innova S44i
S44I041003	<b>Stacking kit</b> for triple stack Innova S44i
S44I041005	<b>Stacking kit</b> for double stack Innova S44i
S44I041006	<b>Stacking kit</b> Stacking an Innova S44i on an Innova 44/44R Innova S44i – Innova 44/44R



Tab. 14-1: Accessories for the universal platform

Erlenmeyer flasks up to 5 L in size can be accommodated. If photosynthetic light or the static incubation shelf is installed, Erlenmeyer flask clamps for flasks of up to 5 L can be accommodated. If the static incubation shelf is installed, Fernbach flasks up to 3 L can be accommodated.

Order no. (International)	Description	Maximum quantity on platform
ACE-10S	10 mL Erlenmeyer flask clamp	238
M1190-9004	25 mL Erlenmeyer flask clamp	238
M1190-9000	50 mL Erlenmeyer flask clamp	130
M1190-9001	125 mL Erlenmeyer flask clamp	81
M1190-9002	250 mL Erlenmeyer flask clamp	48
M1190-9003	500 mL Erlenmeyer flask clamp	36
ACE-1000S	1 L Erlenmeyer flask clamp	20
ACE-2000S	2 L Erlenmeyer flask clamp (for wide neck Erlenmeyer flasks)	14
ACE-3000S	3 L Erlenmeyer flask clamp	9
ACE-4000S	4 L Erlenmeyer flask clamp	8
ACE-5000S	5 L Erlenmeyer flask clamp	6
M1190-9005	2 L Lauber Thomson flask clamp (for narrow neck Erlenmeyer flasks and 2.5 – 2.8 L Thomson flasks)	13
ACFE-2800S	2.8 L Fernbach flask clamp	8
ACSB-500S	500 mL media bottle clamp	30
ACSB-1000S	1000 mL media bottle clamp	20
Different hole diameters available, refer to <a href="http://www.eppendorf.com">www.eppendorf.com</a>	Test tube rack, small	12
	Test tube rack, medium	10
	Test tube rack, large	7
M1289-0700	Microplate rack, stack	20
TTR-221	Microplate rack, single layer	4
M1250-9700	Sticky pad	9

Tab. 14-2: Dedicated platforms

Order no. (International)	Description	Maximum quantity on platform
S44I040002	125 mL Erlenmeyer flask clamp	86
S44I040003	250 mL Erlenmeyer flask clamp	53
S44I040004	500 mL Erlenmeyer flask clamp	39
S44I040005	1 L Erlenmeyer flask clamp	23
S44I040006	2 L Erlenmeyer flask clamp	15
S44I040010	2 L Lauber Thomson flask clamp	15

**Ordering Information**Innova® S44i  
English (EN)**14.3 Spare parts**

<b>Order no. (International)</b>	<b>Description</b>
S44I862015	<b>Drain tubing kit</b> Base drain tubing, refrigeration drain tubing Innova S44i
S44I862020	<b>Transport packaging</b> Incl. pallet, cardboard box Innova S44i

**14.4 Connectivity**

<b>Order no. (International)</b>	<b>Description</b>
1006 073.006	<b>Cable</b> to connect devices with ethernet interface to VisioNize VisioNize box, Ethernet, length 5 m

**Index**

**A**

Accessories.....105  
 Agitation .....98  
 Alarm  
     Alarm limits.....60  
     Alarm settings .....60  
     Door alarm .....62  
     Speed alarm .....63  
     Temperature alarm.....63  
 Application parameters .....98

**B**

Balance Master.....51

**C**

Chamber light.....49  
 Chamber temperature .....98  
 Cleaning .....87  
     Cleaning the touch screen .....89  
     Routine cleaning .....88  
 Connection  
     Electrical connection .....23  
 Counterbalance .....51

**D**

Decontamination .....87  
     Wipe decontamination .....88  
 Device  
     Register .....24  
 Disposal .....94  
 Door  
     Opening the door .....27  
 Door alarm.....62

**F**

Flask clamps.....22

**G**

Grow light .....99

**I**

Installation of platform .....19  
 Interfaces .....14

**L**

Load .....98

**N**

Network  
     VisioNize touch enabled device .....24

**P**

Photosynthetic light.....99  
     Setting the photosynthetic light .....40  
 Platform load .....98  
 Product overview  
     Back view .....14  
     Front view.....13  
 Programs .....70  
     Using programs.....72

**R**

Register.....24

**S**

Setting the chamber light .....49  
 Speed .....98  
     Setting the speed value .....38  
 Speed alarm .....63  
 Spills .....89  
 Storage.....94

**T**

Technical data  
     Ambient conditions .....95

**Index**Innova® S44i  
English (EN)

Temperature .....	98
Setting the temperature value.....	37
Temperature alarm	
Setting the door alarm .....	62
Setting the speed alarm .....	63
Setting the temperature alarm .....	63
Temperature offset	
Calculating the temperature offset .....	50
<b>V</b>	
VisioNize Lab Suite .....	16
<b>W</b>	
Wipe decontamination .....	88

# Declaration of Conformity

The product named below fulfills the requirements of directives and standards listed. In the case of unauthorized modifications to the product or an unintended use this declaration becomes invalid. This declaration of conformity is issued under the sole responsibility of the manufacturer.

**Product name:**

Innova® S44i Incubated  
including accessories

**Product type:**

Incubator Shaker

**Relevant directives / standards:**

2014/35/EU: EN 61010-1, EN 61010-2-010, EN 61010-2-051

2014/30/EU: EN 61326-1, EN 55011 (class A)

2011/65/EU: EN IEC 63000  
(incl. (EU) 2015/863)

Further applied standards: IEC 61010-1, IEC 61010-2-010, IEC 61010-2-051  
UL 61010-1, UL 61010-2-010, UL 61010-2-051  
CAN/CSA C22.2 No. 61010-1-12, CSA C22.2 No. 61010-2-010,  
CSA C22.2 No. 61010-2-051  
IEC 61326-1, CISPR 11, FCC 47 CFR Part 15 (class A)

Hamburg, August 06, 2021



Dr. Wilhelm Plüster  
Management Board



Dr. Marlene Jentzsch  
Senior Vice President  
Division Separation & Instrumentation

Your local distributor: [www.eppendorf.com/contact](http://www.eppendorf.com/contact)  
Eppendorf AG · Barkhausenweg 1 · 22339 Hamburg · Germany  
[eppendorf@eppendorf.com](mailto:eppendorf@eppendorf.com)

ISO  
9001  
Certified

ISO 13485  
Certified

ISO 14001  
Certified

Eppendorf® and the Eppendorf Brand Design are registered trademarks of Eppendorf AG, Germany. Innova® is a registered trademark of Eppendorf Inc., USA.  
All rights reserved, incl. graphics and images. Copyright ©2021 by Eppendorf AG.

# Declaration of Conformity

The product named below fulfills the requirements of directives and standards listed. In the case of unauthorized modifications to the product or an unintended use this declaration becomes invalid. This declaration of conformity is issued under the sole responsibility of the manufacturer.

**Product name:**

Innova® S44i Refrigerated  
including accessories

**Product type:**

Incubator Refrigerator Shaker

**Relevant directives / standards:**

2014/35/EU: EN 61010-1, EN 61010-2-010, EN 61010-2-011, EN 61010-2-051

2014/30/EU: EN 61326-1, EN 55011 (class A)

2011/65/EU: EN IEC 63000  
(incl. (EU) 2015/863)

Further applied standards: IEC 61010-1, IEC 61010-2-010, IEC 61010-2-011, IEC 61010-2-051  
UL 61010-1, UL 61010-2-010, UL 61010-2-011, UL 61010-2-051  
CAN/CSA C22.2 No. 61010-1-12, CSA C22.2 No. 61010-2-010,  
CSA C22.2 No. 61010-2-011, CSA C22.2 No. 61010-2-051  
IEC 61326-1, CISPR 11, FCC 47 CFR Part 15 (class A)

Hamburg, August 06, 2021



Dr. Wilhelm Plüster  
Management Board



Dr. Marlene Jentzsch  
Senior Vice President  
Division Separation & Instrumentation

Your local distributor: [www.eppendorf.com/contact](http://www.eppendorf.com/contact)  
Eppendorf AG · Barkhausenweg 1 · 22339 Hamburg · Germany  
[eppendorf@eppendorf.com](mailto:eppendorf@eppendorf.com)

ISO  
9001  
Certified

ISO 13485  
Certified

ISO 14001  
Certified

Eppendorf® and the Eppendorf Brand Design are registered trademarks of Eppendorf AG, Germany. Innova® is a registered trademark of Eppendorf Inc., USA.  
All rights reserved, incl. graphics and images. Copyright ©2021 by Eppendorf AG.



# Evaluate Your Manual

Give us your feedback.

[www.eppendorf.com/manualfeedback](http://www.eppendorf.com/manualfeedback)

**Your local distributor: [www.eppendorf.com/contact](http://www.eppendorf.com/contact)**

Eppendorf AG · Barkhausenweg 1 · 22339 Hamburg · Germany  
[eppendorf@eppendorf.com](mailto:eppendorf@eppendorf.com) · [www.eppendorf.com](http://www.eppendorf.com)