

Register your instrument!  
[www.eppendorf.com/myeppendorf](http://www.eppendorf.com/myeppendorf)



Thermal Cycler  
Mastercycler<sup>®</sup> X50

**Operating Manual**  
From software version 3.1

Copyright © 2024 Eppendorf SE, Germany. All rights reserved, including graphics and images. No part of this publication may be reproduced without the prior permission of the copyright owner.

Eppendorf® and the Eppendorf Brand Design are registered trademarks of Eppendorf SE, Germany.

Eppendorf trademarks and trademarks of third parties may appear in this manual. All trademarks are the property of their respective owners. The respective trademark name, representations and listed owners can be found on [www.eppendorf.com/ip](http://www.eppendorf.com/ip).

The software included in this product contains copyrighted software that is licensed under the GPL. A copy of that license is included in the settings of the device. You may obtain the complete corresponding source code from us for a period of three years after our last shipment of this product. Please direct your request to [eppendorf@eppendorf.com](mailto:eppendorf@eppendorf.com).

U.S. Patents and U.S. Design Patents are listed on [www.eppendorf.com/ip](http://www.eppendorf.com/ip).

## Table of contents

<b>1</b>	<b>About this manual</b>	<b>6</b>
1.1	Notes on this manual	6
1.2	Warning notice structure	6
1.3	Graphics	6
1.4	Other applicable documents	7
<b>2</b>	<b>Safety</b>	<b>8</b>
2.1	Intended use	8
2.2	Residual risks when used as intended	8
2.2.1	Personal injury	8
2.2.2	Material damage	9
2.3	Application limits	10
2.4	Target groups	10
2.5	Information for the owner	11
2.6	Personal protective equipment	11
2.7	Information on product liability	11
2.8	Information and symbols on the device	12
<b>3</b>	<b>Product description</b>	<b>13</b>
3.1	Features	13
3.2	Product overview	14
3.3	Status lamp	14
3.4	Control panel	15
3.4.1	Touch screen	15
3.4.2	Operating controls	16
3.4.3	Symbols	16
3.5	Accessories	17
3.5.1	Temperature Verification System	17
3.5.2	Permitted sample tubes	17
<b>4</b>	<b>Functional description</b>	<b>18</b>
4.1	Circuit technology	18
4.2	SteadySlope	18
4.3	Program Migration	18
4.4	flexlid heated lid	18
4.5	Thermal Sample Protection	18
4.6	Self-test function	18
4.7	VisioNize Lab Suite	18
4.8	Control of the ECO variants	19
<b>5</b>	<b>Installation</b>	<b>20</b>
5.1	Preparing installation	20
5.1.1	Checking the delivery	20
5.1.2	Checking connection requirements	20
5.1.3	Checking the location	21
5.1.4	Unpacking the device	21
5.2	Performing the installation	22

5.2.1	Setting up the device.....	22
5.2.2	Connecting the device to the voltage supply.....	22
5.2.3	Connecting the device to a network.....	22
5.2.4	Connecting multiple devices.....	23
<b>6</b>	<b>User management.....</b>	<b>25</b>
6.1	User administration concept.....	25
6.2	Roles and rights.....	25
6.3	Setting up user management.....	26
6.4	Editing the user management.....	27
6.5	Disabling the user management.....	27
6.6	Creating a user account.....	28
6.7	Editing a user account.....	28
6.8	Deleting a user account.....	29
6.9	Logging in as a user.....	29
6.10	Editing password or PIN.....	29
6.11	Logging off as a user.....	30
<b>7</b>	<b>Operation.....</b>	<b>31</b>
7.1	Home screen.....	31
7.2	Preparing the device for the application.....	31
7.2.1	Switching the device on.....	31
7.2.2	Configuring the network.....	32
7.2.3	Setting the date and time.....	32
7.2.4	Entering device parameters.....	33
7.2.5	Activating the signal tone.....	33
7.2.6	Configuring the touch screen.....	33
7.2.7	Registering the device for VisioNize.....	34
7.2.8	Setting up automatic restart (Auto Restart).....	35
7.3	Application.....	36
7.3.1	Opening the Program Manager.....	36
7.3.2	Creating a folder.....	36
7.3.3	Managing folders and programs.....	36
7.3.4	Setting up programs.....	37
7.3.5	Importing programs.....	37
7.3.6	Administration of programs.....	38
7.3.7	Setting the program.....	39
7.3.8	Editing the program.....	41
7.4	Loading the thermoblock.....	44
7.5	Starting a program.....	44
7.6	Interrupting or aborting a program.....	45
7.7	Incubating.....	45
7.8	Accessing Events.....	46
7.9	Opening logs.....	46
<b>8</b>	<b>Maintenance.....</b>	<b>47</b>
8.1	Maintenance plan.....	47
8.2	Service.....	47
8.2.1	Servicing the device.....	47

8.2.2	Checking the functionality.....	47
8.2.3	Verifying the device.....	47
8.2.4	Data export.....	48
8.2.5	Updating software.....	48
8.3	Cleaning.....	49
8.3.1	Cleaning the device.....	49
8.3.2	Disinfecting the device.....	50
8.3.3	Cleaning the touch screen.....	51
<b>9</b>	<b>Troubleshooting.....</b>	<b>52</b>
9.1	Processing messages.....	52
9.2	Entering contact details.....	52
9.3	Accessing service information.....	52
<b>10</b>	<b>Shut down.....</b>	<b>53</b>
10.1	Switching off the device.....	53
10.2	Disconnecting the device from the mains/power supply.....	53
<b>11</b>	<b>Transport.....</b>	<b>54</b>
11.1	Preparing the device for transport.....	54
11.2	Transporting the device.....	54
11.3	Shipping the device.....	54
<b>12</b>	<b>Storage.....</b>	<b>56</b>
12.1	Preparing the device for storage.....	56
<b>13</b>	<b>Disposal.....</b>	<b>57</b>
13.1	Legal requirements.....	57
13.2	Preparing for disposal.....	57
13.3	Handing over the device to the disposal company.....	58
<b>14</b>	<b>Technical data.....</b>	<b>59</b>
14.1	Dimensions.....	59
14.2	Weight.....	59
14.3	Mains/power supply.....	59
14.4	Ambient conditions.....	60
14.5	Electromagnetic compatibility.....	60
14.6	Interfaces.....	60
14.7	Noise level.....	61
14.8	Application parameters.....	61
<b>15</b>	<b>Glossary.....</b>	<b>63</b>
<b>16</b>	<b>Index.....</b>	<b>64</b>

## 1 About this manual

### 1.1 Notes on this manual

1. Please read this manual before you use the product.
2. Please ensure that you have the manual available during the use of the product.

-  You can find the current version of the manual at [www.eppendorf.com/manuals](http://www.eppendorf.com/manuals).
  - Please contact Eppendorf SE to obtain a different version of the manual.





### 1.2 Warning notice structure





#### HAZARD LEVEL! Type of danger

Source of danger  
 Consequences of disregarding the danger

- Measures to avoid the danger

Symbol	Hazard level	Type of danger	Meaning
	<b>DANGER</b>	Personal injury	Will lead to severe injuries or death.
	<b>WARNING</b>	Personal injury	May lead to severe injury or death.
	<b>CAUTION</b>	Personal injury	May lead to minor or moderate injuries.
	<b>NOTE</b>	Material damage	May lead to material damage.

### 1.3 Graphics

Depiction	Meaning
1.	Work steps
2.	
•	Bullet point
<i>Text</i>	Display text
<b>Key</b>	Name for port, button, status lamp, or key
	Important information
	Hint

## 1.4 Other applicable documents

The following documents supplement this manual:

- Instructions for accessories and consumables
- CycleManager X50 software manual

## 2 Safety

### 2.1 Intended use

The Mastercycler X50 is a laboratory device for the amplification of nucleic acids using polymerase chain reaction (PCR). This device is intended for general laboratory use and may only be operated by persons trained in laboratory techniques and procedures.

### 2.2 Residual risks when used as intended

If the product is not used as intended, the installed safety devices may not function correctly. To reduce the risk of personal injury and material damage and to avoid dangerous situations, please observe the general safety instructions.

#### 2.2.1 Personal injury

##### 2.2.1.1 Biological hazards

Pathogenic biological agents can harm your health and the environment.

- Observe the national regulations and the biosafety level of your laboratory.
- Wear your personal protective equipment.
- Observe the Safety Data Sheets and instructions for use for the accessories.
- Read the "Laboratory Biosafety Manual" (source: World Health Organization, Laboratory Biosafety Manual, in its current version) about handling germs or biological material of risk group II or higher.

The use of highly flammable substances can cause fires.

- Heat highly flammable substances only in small quantities below the boiling point.
- Do not exceed the boiling point of solutions.

When tempering with an open heated lid, the lids of the reaction vessels can spring open. The sample material released in this way will result in contamination and damage to health.

- Temper only with the heated lid closed.

##### 2.2.1.2 Electrical hazards

If you touch parts that are under high voltage, you may receive an electric shock. A fatal electric shock causes cardiac arrhythmia and respiratory paralysis.

- Use only earth/grounded sockets with a PE conductor.
- Make sure that a residual current circuit breaker is present and accessible.
- Make sure that the housing and the mains/power cord are undamaged.
- Disconnect the device from the mains/power supply voltage in an emergency situation.
- Do not open or remove the housing.
- Compare the technical information on the mains/power cord and mains/power plug with the technical information on the name plate, taking into account national laws and regulations. This also includes test seals if they are required by law. Use only approved mains/power cords with plugs.
- Make sure that the mains/power plug and earth/grounded socket match and that the electrical PE conductors of the device and the building installation are securely connected to each other.



- Clean and perform maintenance on the device only when it is disconnected from the mains/power line.
- Have the device regularly checked for electrical safety in accordance with national requirements.

### 2.2.1.3 Mechanical hazards

The handle is not suitable for transporting the device. If you lift the device by its handle, the handle may break. The device may fall down and cause injuries.

- Reach underneath the device to lift it.

### 2.2.1.4 Thermal hazards

The thermoblock, the heated lid and reaction tubes very quickly achieve temperatures over 50 °C. Contact with hot elements may cause burn injuries.

- Wait for the temperature of the thermoblock, the heated lid and reaction tubes to drop below 30 °C.
- Open the heated lid after this.

## 2.2.2 Material damage

### 2.2.2.1 Electrical hazards

Connecting the device to an incorrect mains/power supply will damage the device.

- Connect the device only to a mains/power supply that meets the requirements on the name plate.
- Use only earth/grounded sockets with a PE conductor.
- Compare the technical information on the mains/power cord and mains/power plug with the technical information on the name plate, taking into account national laws and regulations. This also includes test seals if they are required by law. Use only approved mains/power cords with plugs.
- Make sure that the mains/power plug and earth/grounded socket match and that the electrical PE conductors of the device and the building installation are securely connected to each other.

Condensate may form in the device due to transport of the device from a cool environment to a warmer environment and cause a short-circuit.

- Wait for at least 4 h after setting up the device. Then, connect the device to the mains/power line.

### 2.2.2.2 Chemical hazards

High humidity during transport or storage may cause condensation inside the device.

- Wait for at least 4 h after setting up the device. Then, connect the device to the mains.

Aggressive chemicals and aggressive cleaning agents and disinfectants may damage the material of the device and accessories. This may lead to damage in the interior of the device during operation.

- Protect all components from aggressive chemicals.
- Clean and disinfect all components only with the recommended cleaning agents and disinfectants. When in doubt whether a cleaning agent or disinfectant is suitable contact the manufacturer.
- Inspect all components for changes in the materials before each use.
- Put damaged devices out of operation.
- Replace damaged accessories.

**Safety**

Mastercycler® X50  
English (EN)

**2.2.2.3 Sample loss**

If the device is connected to the Internet, the device functions may be disrupted by a cyberattack. Samples may become unusable due to the malfunction.

- Use a firewall or a VPN solution.
- Do not use network address translation (NAT).
- Enable OPC/REST if necessary.

While the device is integrated into a network and the TVS-T6 support is enabled, the device functions may be disrupted by a cyber-attack. The device may no longer be available. Samples may become unusable.

- Only enable the TVS-T6 support if the device is connected directly to the TVS-T6.

**2.3 Application limits**

Due to its design, the product is not suitable for use in a potentially explosive atmosphere.

The product may only be used in a safe environment, such as a ventilated laboratory or under a fume hood. Substances which may potentially contribute to an explosive atmosphere may not be used.

**2.4 Target groups**

This manual is intended for the following target groups, who have different qualifications and levels of knowledge.

**Owner**

The owner is any natural or legal person who operates or owns the device.

The owner provides the product and the necessary infrastructure. The owner has a special responsibility to ensure the safety of all persons working on the product.

**User**

The user operates the product and works with it. The user must be instructed in the use of the product. The user must have read and fully understood the manual.

Any tasks that go beyond operation may only be performed by the user if this is specified in this manual. The owner must explicitly assign these tasks to the user.

**Technical personnel**

The technical personnel supervises the building services and ensures the technical prerequisites for the operation of the product.

**Authorized service technician**

The authorized service technician is trained and certified by Eppendorf SE to service, maintain and repair the product.

## 2.5 Information for the owner

The owner must ensure the following:

- The product is in a safe operating condition.
- The safety devices are all available and functional.
- The product is serviced and cleaned according to the information in this manual.
- The product is disposed of in accordance with local regulations.
- All work on the product is carried out by users, technical personnel or authorized service technicians who are suitably qualified.
- Personal protective equipment is available and is worn.
- The manual is available during the use of the product.
- The manual is part of the product. The product will only be passed on to others with its manual.

## 2.6 Personal protective equipment

Personal protective equipment serves to ensure the safety and protection of the user when working with the product.

Personal protective equipment must comply with country-specific regulations and the regulations of the laboratory.

## 2.7 Information on product liability

The owner of the device will be held liable for personal and material damage in the following cases:

- The device is used outside of its intended use
- The device is not used in accordance with the operating manual
- Manipulation of safety devices
- The device has spare parts installed that are not authorized by Eppendorf SE
- The device is used with accessories or consumables that are not recommended by Eppendorf SE
- Cleaning agents are used that are not recommended by Eppendorf SE
- Chemicals are used that are not recommended by Eppendorf SE
- Shipment not in original packing or in improper substitute packing
- The device is maintained or repaired by persons not authorized by Eppendorf SE
- Unauthorized modifications

## 2.8 Information and symbols on the device

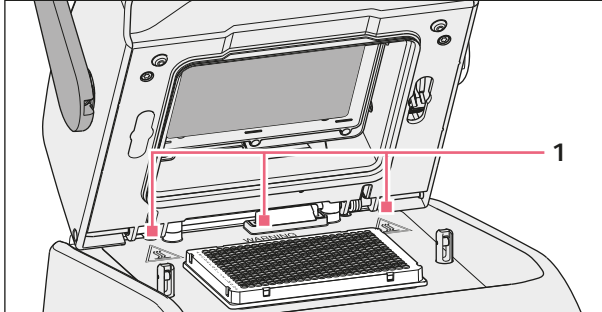





Fig. 2-1: Warning symbols on the device

Information	Meaning
 <p style="text-align: center;"><b>WARNING</b>            Hot surfaces on block and lid            Do not touch</p> 	<p>Risk of burns on hot surfaces</p> <p>When the heated lid is open, you can burn yourself on the thermoblock and heating plate.</p>
	<p>On/Off mains/power switch as rocker switch</p> <p>O: switched off</p> <p>I: switched on</p> <p>IEC 61058-1</p>

## 3 Product description

### 3.1 Features

#### Mastercycler X50

The device has the following features:

- 3 different thermoblocks:
  - 2 for 96-well plates with aluminum or silver block
  - 1 for 384-well plates with aluminum block
- Temperature gradient: 2D-gradient, X and y-axis
- flexlid concept
- Up to 9 Mastercycler X50 eco can be connected
- Touch screen
- VisioNize connection
- Interfaces: USB, Ethernet

#### Mastercycler X50 eco

The device has the following features:

- 3 different thermoblocks:
  - 2 for 96-well plates with aluminum or silver block
  - 1 for 384-well plates with aluminum block
- Temperature gradient: 2D-gradient, X and y-axis
- flexlid concept
- Display
- Interface: Ethernet



You can use a Mastercycler X50 to control a directly connected Mastercycler X50 eco. Using an Ethernet switch, you can connect and control up to 9 Mastercycler X50 eco. Make sure that IGMP snooping from the IEEE 802.3 Ethernet switch does not interfere with the device's network. To do this, disable the IGMP snooping function if enabled.

With the CycleManager X50 software, up to 50 Mastercycler X50 eco can be connected to a PC via an Ethernet switch. No Mastercycler X50 is required for this.

### 3.2 Product overview

#### Mastercycler X50

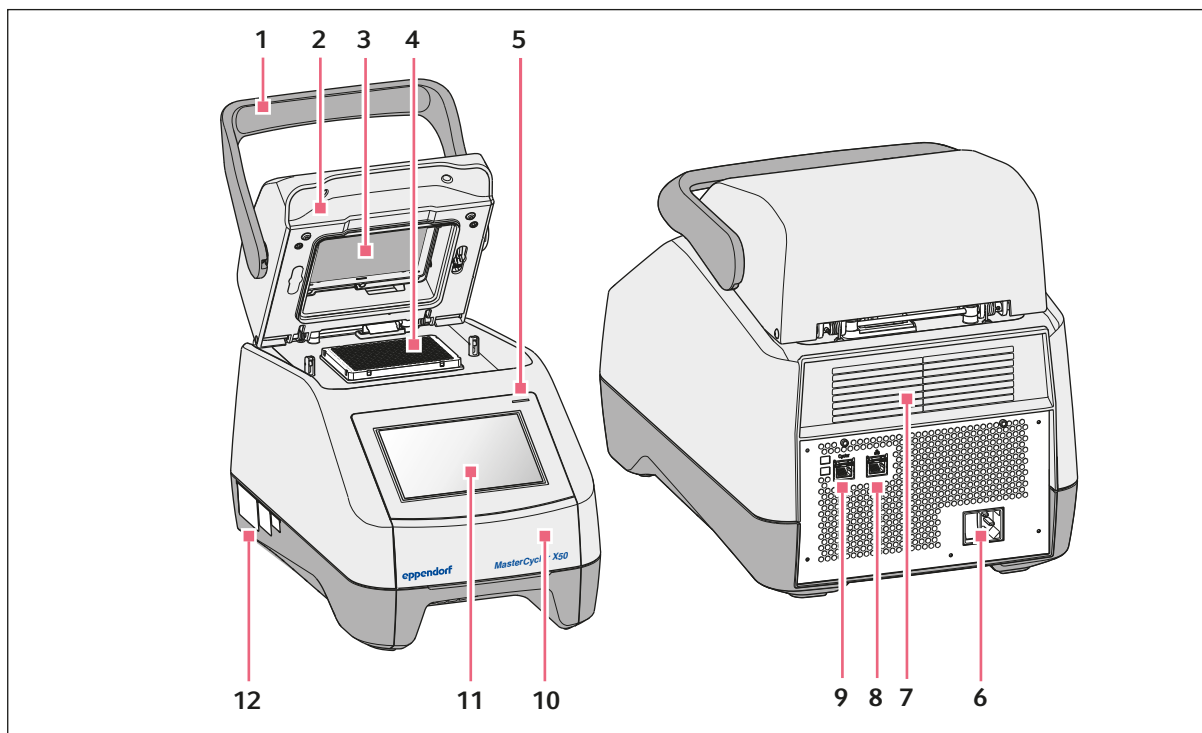

Fig. 3-1: Front view and rear view

- |  |  |
|--|--|
| <ul style="list-style-type: none"> <li>1 Lid handle</li> <li>2 Heated lid</li> <li>3 Heating frame</li> <li>4 Thermoblock</li> <li>5 Status lamp</li> <li>6 Mains/power cord socket with mains/power switch</li> </ul> | <ul style="list-style-type: none"> <li>7 Ventilation gaps (also on the bottom of the device, not shown)</li> <li>8 Ethernet port</li> <li>9 Cycler port</li> <li>10 Cover of the USB port</li> <li>11 Touch screen</li> <li>12 Name plate</li> </ul> |
|--|--|

### 3.3 Status lamp

Status lamp	Operating state
Lights up yellow	The device is starting up.
Briefly flashes yellow and then lights up white	The device is in idle mode.
Flashing blue light	A program run is active.
Flashes green	A program run has been completed.

Status lamp	Operating state
Flashes yellow	The program run is waiting for a user action in the pause or hold step.
	The lid is left open during a program run.
Lights up blue	The heating block is active. No program is selected.
	The heated lid is active. No program is selected.
	Verification of the thermoblock
Lights up violet	The device will restart automatically after a mains/ power outage.
Flashes red	Device error Additional information about the type of error is shown on the display.
Flashes violet	Software update

### 3.4 Control panel

#### 3.4.1 Touch screen

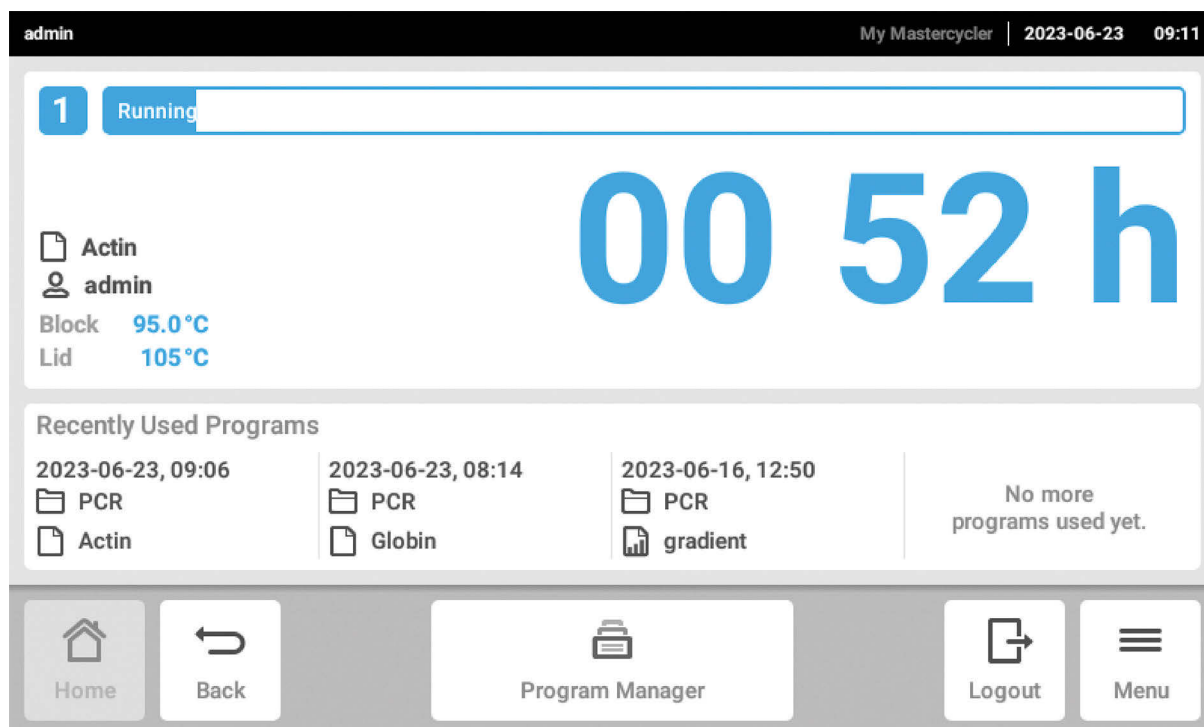

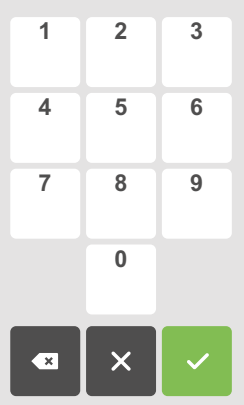













Fig. 3-2: Home screen during a standard PCR run







### 3.4.2 Operating controls

Operating control	Function
	Increase and reduce values gradually
	Enter a value

### 3.4.3 Symbols

Symbol	Description
	Edit data
	Activate filter
	Log in user
	Log out
	Alarm
	Deactivate the signal tone
	Call events
	Alarm message
	Error message
	Warning message
	Notification



Symbol	Description
	Call up unconfirmed messages The number shows the number of unconfirmed messages.
	Confirm the current message in the notification bar
	Confirm all messages in the notification bar
	Message not confirmed
	Message confirmed
	Open the export area and export data

### 3.5 Accessories

#### 3.5.1 Temperature Verification System

The device can be connected to this peripheral temperature measuring device for verifying and adjusting the thermoblock temperature control for thermal cyclers.

#### 3.5.2 Permitted sample tubes

The sample tubes must be seated accurately in the thermoblock and have a minimum temperature resistance of 110 °C.

Use sample tubes of one type only to ensure that they are all the same height. This also ensures that the sample tubes are pushed into the thermoblock evenly.

The following sample tubes are permitted for devices with a 96-well thermoblock

- 0.1 mL PCR strip; max. volume of 100 µL
- 0.2 mL PCR tubes; max. volume of 100 µL
- 96-well PCR plates; skirted, semi-skirted or unskirted; max. volume 100 µL

The following sample tubes are permitted for devices with a 384-well thermoblock

- 384-well PCR plates; skirted; max. volume 25 µL

## Functional description

Mastercycler® X50

English (EN)

## 4 Functional description

### 4.1 Circuit technology

The circuit technology ensures a homogeneous temperature distribution and enables the generation of specific temperature gradients for PCR optimization.

### 4.2 SteadySlope

The SteadySlope technology ensures that the heating and cooling rates of the thermoblock in gradient operation are identical to those in normal operation. The reliable transfer of optimization results to the routine application is ensured.

### 4.3 Program Migration

Program Migration enables the transfer of a PCR program from other thermal cyclers with a lower temperature control speed to the device. The required runtime is entered and the device calculates the matching ramps automatically. This function enables a simulation of the PCR program execution without performing PCR optimization first.

### 4.4 flexlid heated lid

The flexlid heated lid enables ergonomic one-hand operation and automatically adjusts the pressure force for all sample tubes and PCR plates.

### 4.5 Thermal Sample Protection

The Thermal Sample Protection technology maintains a constant thermoblock temperature of 20 °C during the warm-up phase of the heated lid. Thermal Sample Protection reduces the thermal load on your samples and minimizes the probability of non-specific product formation during the PCR.

### 4.6 Self-test function

The device has an integrated self-test function. The self-test function provides a simple way of testing the correct function of the thermoblock without any further auxiliary equipment.

### 4.7 VisioNize Lab Suite

VisioNize Lab Suite is a cloud-based platform.

To send, for example, performance data to the VisioNize Lab Suite, you can integrate the device into a local network via a standard SF/FTP, S/FTP, SF/UTP, or S/UTP Ethernet cable.

For more information, contact your local Eppendorf partner and refer to the VisioNize Lab Suite Setup Guide.

## **4.8 Control of the ECO variants**

The ECO variants of the Mastercycler X50 do not have a control panel. They are controlled via a connected master variant of the Mastercycler X50.

## 5 Installation

### 5.1 Preparing installation

#### 5.1.1 Checking the delivery

 Do not use the product if the packing or the contents are damaged. In case of damaged or missing parts, contact the Eppendorf SE customer service or your Eppendorf partner.

1. Check the packing and the contents for any visible external damage.
2. Check whether the delivery is complete and matches the order.

Quantity	Description
1	Mastercycler X50 in the variant ordered
1	Mains/power cord with EU-plug
1	Mains/power cord with US-NEMA plug
1	English short instructions
1	Safety information supplement
1	Certificate of uniformity (confirms temperature homogeneity, accuracy, ramping rate)

 Keep the original packing for shipping and storing the device.

#### 5.1.2 Checking connection requirements

All prerequisites must be met before the device can be installed and put into operation.

##### Checking the electrical connections



##### **DANGER! Electric shock**

If the PE conductor connection is missing, you may receive an electric shock. An electric shock causes cardiac injuries and respiratory paralysis.

- Make sure that the mains/power plug and earth/grounded socket match and that the electrical PE conductors of the device and the building installation are securely connected to each other.

 Do **not** use multiple sockets.

1. Check whether the electrical connection meets the following requirements:
  - The mains/power connection meets the requirements on the name plate.
  - An earth/grounded socket with a PE conductor is available.
  - The earth/grounded socket can be reached with the mains/power cord. Junction boxes or extension cables are not allowed.
  - The earth/grounded socket is always freely accessible.
  - A residual current circuit breaker is available and accessible.
  - The mains/power plug on the device or the earth/grounded socket is accessible at all times during operation so that the device can be properly disconnected from the mains/power line.
2. Connect the mains/power cord of each device directly to a earth/grounded socket.

### 5.1.3 Checking the location

1. Check that the location meets the following requirements:
  - The ambient conditions match the specifications set out in [↪ Chapter 14 "Technical data" on page 59](#)
  - Resonance-free table with a horizontal, even and non-slip work surface
  - The location is designed to carry the weight of the device
  - Good ventilation, no obstructions within a distance of 30 cm from the ventilation gaps
  - The mains/power switch of the device and the disconnecting device of the power system circuit can be accessed
  - Ergonomic height of the installation location
2. Check whether the location is protected from the following influences:
  - Heat sources
  - Sparks
  - Open flames
  - Direct exposure to sunlight
  - UV radiation
  - Strong electromagnetic radiation
  - Humidity

### 5.1.4 Unpacking the device

1. Open the packing.
2. Remove the accessories from the packing.
3. Remove the transport pads.



#### **CAUTION! Personal injury**

Lifting the device by the handle may cause the handle to break. The device may fall down and cause injuries.

- Lift the device by placing your hands under the housing.

4. Hold the device by its underside and lift the device out of the packing with a sufficient number of people.
5. Remove the plastic wrapping from the device.

## 5.2 Performing the installation

### 5.2.1 Setting up the device

1. Place the device in its intended location.
2. Remove all objects from the location that interfere with the supply of air to the ventilation gaps.
3. Remove the PCR plate from the thermoblock.

### 5.2.2 Connecting the device to the voltage supply

Prerequisites:

- The device has been set up.
1. Connect the IEC connector to the rear of the device.
  2. Plug the mains/power plug into the earth/grounded socket.

### 5.2.3 Connecting the device to a network

You can connect the master device directly to the Internet and an internal network. An Internet connection is not necessary to operate the device. If the master device is connected to the Internet, the owner is responsible for data security.

- Make sure that a connection to the internal network or the Internet is only established by a network administrator.
- Check the internal network or Internet settings before establishing a connection.

The device has a network port (RJ-45 plug). You can work via DHCP or with a fixed IP. The port works with any common Ethernet-based infrastructure. 100 MBit or 1 GBit ports (autonegotiation) are recommended.

Prerequisites:

- The device is switched on.
1. Connect the master device to the internal network via the **Cycler** port.
  2. Connect the eco device to the internal network via the **Cycler** port.

The master device detects the eco devices in the network. Assign the eco device to the master device (see [☞ "Connecting an eco device directly to the master device" on page 23](#)).

3. Connect the master device to the Internet via port **2**.

## 5.2.4 Connecting multiple devices

### Connecting an eco device directly to the master device

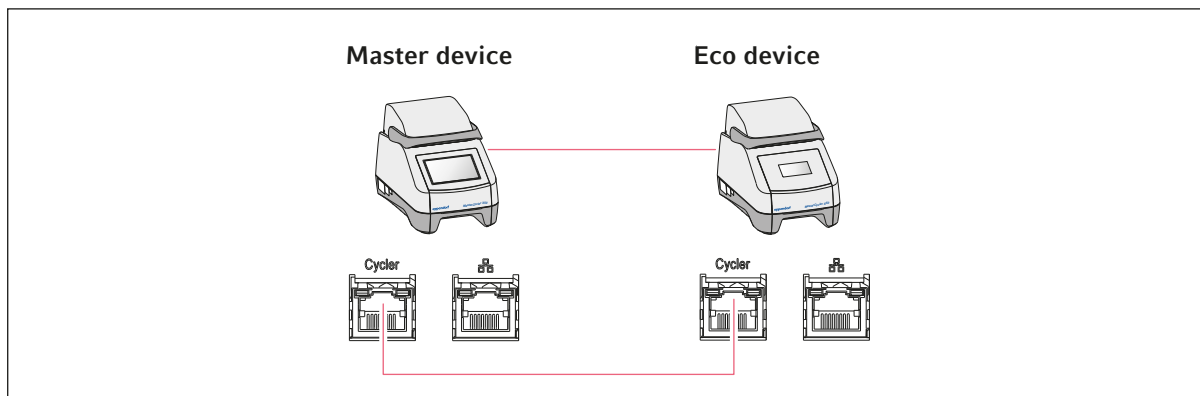

**i** Make sure that IGMP snooping from the IEEE 802.3 Ethernet switch does **not** interfere with the mastercycler's network. To do this, disable the IGMP snooping function if enabled.

1. Connect the master device to the eco device via the **Cycler** port.  
 The master device detects the eco device.
2. To assign the eco device to the master device, tap on *Menu > Settings > System Settings > Assignment*.
3. Tap on the plus sign in an empty slot.  
 A list of all available devices is displayed.
4. Select a device.  
 The four-digit registration ID of the eco device appears on the corresponding display.
5. Enter the *registration ID* and confirm your entry.

### Connecting multiple eco devices

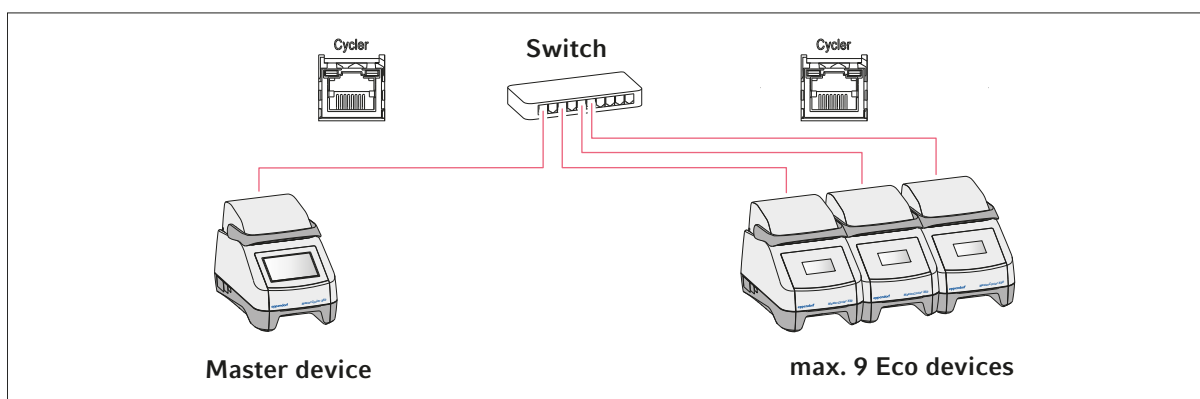

1. Connect the master device to the Ethernet switch via the **Cycler** port.
2. Connect the eco devices to the Ethernet switch via the **Cycler** ports.

**Installation**

Mastercycler® X50

English (EN)

3. To assign the eco devices to the master device, tap on *Menu > Settings > System Settings > Assignment*.
4. Tap on the plus sign in an empty slot.  
A list of all available devices is displayed.
5. Select a device.
6. Enter the *registration ID* and confirm your entry.
7. Repeat the assignment for each device.



## 6 User management

### 6.1 User administration concept

User management is used to organize the access to the device.

3 user roles have been defined:

- Administrator
- User with standard rights
- User with restricted rights

If user management has not been set up, all users have the same rights as an administrator. The first user account that is created will automatically be the administrator account.

### 6.2 Roles and rights

Tasks	<i>Administrator</i>	<i>User</i>	<i>Restricted User</i>
Exporting logs	×	×	×
Login/logout	×	×	×
Changing your own password	×	×	×
Viewing administrator settings (does not apply to user management)	×	×	×
Viewing device information	×	×	×
Viewing logs	×	×	×
Starting a self test	×	×	×
Viewing a program	×	×	× (shared)
Viewing program folders	×	×	× (shared)
Selecting a program for PCR run	×	×	×
Entering run ID	×	×	×
Starting a PCR run	×	×	× (released programs only)
Interrupting a PCR run	×	×	×
Stopping a PCR run	×	×	×
Selecting the incubation temperature	×	×	×
Starting incubation	×	×	×
Starting incubation	×	×	×
Stopping incubation	×	×	×
Viewing user settings	×	×	×
Editing user settings	×		

**User management**

Mastercycler® X50

English (EN)

<b>Tasks</b>	<b>Administrator</b>	<b>User</b>	<b>Restricted User</b>
Displaying <i>Program information</i>	×	×	×
Calling up <i>Events</i>	×	×	×
Setting service intervals	×	×	
Using <i>Sketch mode</i>	×	×	
Importing or exporting programs	×	×	× (export only)
Editing programs	×	×	
Allocating programs to a folder	×	×	
Creating, editing and deleting folders	×	×	
Cutting, copying and pasting folder content	×	×	
Deleting folder content	×	×	
Maintaining programs (protected access to programs)	×	×	
Selecting a program template	×	×	
Releasing programs	×	×	
Setting access rights for folders	×	×	
Sharing folders	×	×	
Verifying the device	×	×	
Setting the <i>Auto Restart</i> function	×		
Setting an acoustic alarm	×		
Assigning eco devices to the system	×		
Configuring network settings	×		
Creating a user account	×		
Updating software	×	×	×
Changing <i>Qualification status</i>	×		
Changing the user name	×		
Changing user rights	×		
Resetting the user password	×		
Deleting a user account	×		

**6.3 Setting up user management**

To set up user management, you need to create an administrator account.

## Creating an administrator account

 If the administrator's credentials are lost, it is no longer possible to make any changes to the user administration and system settings. In this case, an authorized service engineer must reset the factory default settings on the device. All user accounts as well as all data and settings stored on the device will be deleted.

- Keep the user ID and the administrator password in a safe location.
- Create a second user account with administrator rights.

1. Tap on *Menu > Settings > User Management*.
2. Activate *User Management*.
3. Select whether users log in with a password or a PIN.
4. Tap on *Continue*.
5. Enter the user name for the administrator.
6. Tap on *Continue*.
7. Enter the password or the PIN. Repeat the entry.
8. Tap on *Confirm*.

The user account for the administrator has been created.

User management is now active and can be edited.

Login data is displayed.

9. Note down the login data for the administrator account.

## 6.4 Editing the user management

Prerequisites:

- You have administrator rights.

1. Tap on *Menu > Settings > User Management*.
2. Define the user management settings:
  - *User Management*: Enable or disable the user management.
  - *Automatic Logout*: Time after which an inactive user will be logged out automatically.
  - *Login Mode*: Login via password or PIN.
  - *Grant all users extra privileges*: If this function is enabled, no login is required and all users of the device have the rights of the selected user role. Even users who are not registered in the user administration can operate the device with the rights that were set.

## 6.5 Disabling the user management

 Disabling the user management will delete all user accounts.

## User management

Mastercycler® X50  
English (EN)

Prerequisites:

- You have administrator rights.

1. Tap on *Menu > Settings > User Management*.
2. Disable the user management.
3. Tap on *Continue*.
4. Enter the password or the PIN.
5. Tap on *Confirm*.

The user management is disabled.

### 6.6 Creating a user account

You can create 999 user accounts.

Prerequisites:

- You have administrator rights.

1. Tap on *Menu > Users*.

The overview of user accounts appears.

2. Tap on *Add User*.

The *New User Credentials* window appears.

3. Enter the name of the new user in the *Enter user name* field and confirm the entry.
4. Assign either the password or the four-digit PIN for the new user. Repeat the entry to confirm.
5. Tap on *Continue*.
6. Select the desired user group from the *Select role* drop-down menu.

User name, user ID and role are displayed.

The new user is assigned to the selected user group.

7. Write down or export the user data you just created.

### 6.7 Editing a user account

#### Editing your own user account

Prerequisites:

- A user is logged in.

1. Tap on *Menu > Users*.
2. Select your user account.
3. Edit the required user data.

## Editing user accounts as administrator

Prerequisites:

- You have administrator rights.

1. Tap on *Menu > Users*.
2. Select a user account.
3. Tap on the corresponding field to change the data.

You can change the entries in the following fields:

- *Full Name*
- *E-mail*
- *User ID*
- *Role*

## 6.8 Deleting a user account



It is not possible to delete the last remaining user account of the user group Administrator.

Prerequisites:

- You have administrator rights.

1. Tap on *Menu > Users*.
2. Highlight the user account you wish to delete.
3. Tap on the recycling bin symbol and confirm your selection.

## 6.9 Logging in as a user

Prerequisites:

- The user management is enabled.
- The user accounts have been created.

1. Tap on *Menu > Login*.
2. Enter your login details.

## 6.10 Editing password or PIN

### Changing the password or PIN

Prerequisites:

- A user is logged in.

1. Tap on *Menu > Users*.
2. Select your user account.
3. Tap on *Change Password/PIN*.

## User management

Mastercycler® X50  
English (EN)

4. Enter the current password in the *Enter current password/PIN* field.
5. Enter the new password in the *Enter new password/PIN* field.
6. Repeat the entry in the *Repeat new password/PIN* field.
7. Confirm the entry.

### Resetting the password or PIN

If a user has forgotten his or her password, the administrator can generate a new password.

Prerequisites:

- You have administrator rights.

1. Tap on *Menu > Users*.
2. Select a user account.
3. Tap on *Reset password/PIN*.
4. Tap on *Reset*.

The new password or PIN is generated and displayed automatically.

### 6.11 Logging off as a user

Prerequisites:

- You are logged in as a user.

1. Tap on *Logout*.

## 7 Operation

### 7.1 Home screen

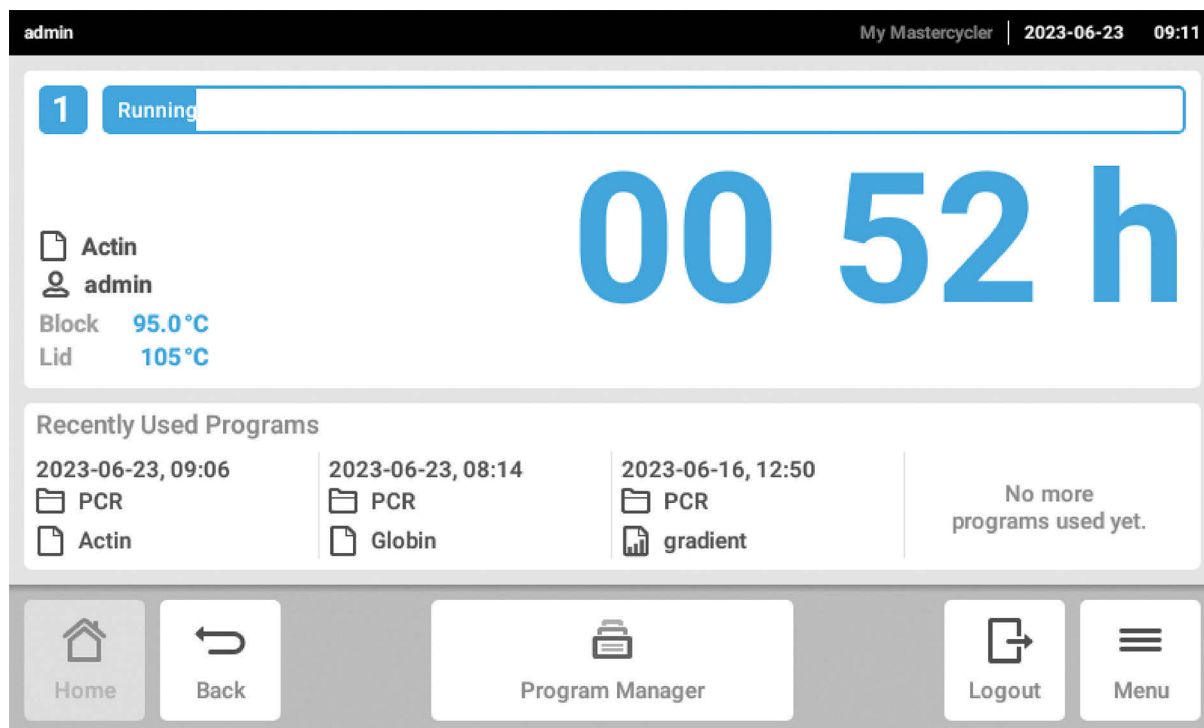

Fig. 7-1: Home screen during a standard PCR run

To access the home screen, tap on *Home*.

## 7.2 Preparing the device for the application

### 7.2.1 Switching the device on

Prerequisites

- The device has been set up and connected in accordance with this operating manual.
- Only put the device into operation when the device is dry.

1. Switch on the mains/power switch.

The status lamp flashes white. The device is started up.

The status lamp lights up in white. The device is ready for operation.

## 7.2.2 Configuring the network

### Configuring the network automatically

Prerequisites:

- You have administrator rights.

1. Tap on *Menu > Settings > System Settings > Network*.
2. Activate the function *Enable DHCP*.

The device will automatically connect to the network.

If the device is integrated in the network, its IP address will appear in the field *IP Addresses*.

### Configuring the network manually

Prerequisites:

- You have administrator rights.

1. Tap on *Menu > Settings > System Settings > Network*.
2. Disable the function *Enable DHCP*.

The field *Manual Setup* is enabled.

3. Tap on *Manual Setup*.
4. Enter the parameters.
5. Confirm the parameters.

The entries are saved. The device connects to the network.

When the device is integrated in the network, its IP address will appear in the field *IP Addresses*.

## 7.2.3 Setting the date and time

Prerequisites

- You have administrator rights.

1. Tap on *Menu > Settings > System Settings > Date & Time*.

### Setting the date and time automatically

Prerequisites

- The device is connected to the network and to a time server.

1. Activate the function *Automatic date & time*.
2. Tap on *Select timezone*.
3. Select the continent.
4. Select the time zone.

The entries are saved.



### Setting the date and time manually

1. Deactivate the function *Automatic date & time*.

The fields *Set date* and *Set time* are active.

2. Tap on *Set date*.
3. Set the current date.
4. Tap on *Confirm*.
5. Tap on *Set time*.
6. Set the current time.
7. Tap on *Confirm*.
8. Tap on *Select timezone*.
9. Select the continent.
10. Select the time zone.

The entries are saved.

### 7.2.4 Entering device parameters

Prerequisites

- You have administrator rights.

1. Tap on *Menu > Settings > About this Mastercycler*.
2. Enter the device-specific parameters.

### 7.2.5 Activating the signal tone

Prerequisites

- You have administrator rights.

1. Tap on *Menu > Settings > Device Settings > Acoustic Signals*.
2. Activate the required function:
  - *Audible Alarms*
  - *Acoustic Notification on Hold Step*
3. To test the signal tone, tap *Test Sound*.

### 7.2.6 Configuring the touch screen

**Adjusting brightness, power saving mode and screensaver**

1. Tap on *Menu > Settings > Device Settings > Display Settings*.
2. Tap on *Display brightness*.
3. Adjust to the required brightness.

4. Activate the *Energy save mode* function to save energy.
5. Tap on *Display timeout*.
6. Select the time after which the display will be dimmed.

### 7.2.7 Registering the device for VisioNize

 You can connect the device to the VisioNize Lab Suite for remote monitoring and alarm notifications.

Prerequisites:

- Use the following required network components:
    - DNS server
    - NTP server
  - Use an automated NTP time server protocol to ensure smooth data transfer between your laboratory devices and the software.
  - To enable communication between your lab devices and the cloud-based VisioNize Lab Suite services, define the following exceptions for the firewall settings:
    - URL: \*.eppendorf.com
    - Interface: 443 TCP
    - Protocol: MQTT via web sockets
  - The Eppendorf device that you want to connect is ready for operation.
  - The latest device software version is installed on the Eppendorf device.
  - You are logged in to the VisioNize Lab Suite as an administrator.
1. Use a standard Ethernet cable to connect the device with your local network.
  2. Check whether the device is connected to the Internet and the VisioNize Lab Suite cloud servers by tapping on *Menu > Contacts & Supports > Diagnostics > Check Cloud Connectivity Prerequisites* on the device's touch screen.

As soon as the device is connected to the Internet and the VisioNize Lab Suite cloud servers the top menu ribbon of the touch screen will display a cloud symbol.

 If the cloud symbol is crossed out although all prerequisites are fulfilled and an Internet connection has been established, please contact your local Eppendorf partner.

3. Click on *Device Management* in the VisioNize Lab Suite.
4. Click on *Add Device +*.
5. Click on *A VisioNize Touch Enabled Device*.
6. Enter the serial number of the device which you want to connect.

 You will find the serial number on the device's name plate on the rear of the device.

The *Next Step* button is enabled.

7. Click on *Next Step*.

8. To send a registration request for the device, click on *Submit*.

 You must send an individual registration request for each VisioNize touch enabled device that you want to register. This request can only be accepted or rejected by an administrator. If you have entered the wrong serial number, the registration request cannot be accepted.

The registration request is displayed in the *Requests* tab in the top left corner.

9. Click on the *Requests* tab.

10. Select the device from the list of registration requests.

11. Click on *Accept Device* to accept the registration request.

 The device data are only documented after the registration request was accepted successfully.

The device is added to the device list in the *Device* tab.

The device is added to the *Monitoring* device list.

## 7.2.8 Setting up automatic restart (Auto Restart)

The Auto Restart function is used to configure whether the execution of a PCR program is to be continued automatically after a mains/power outage. By default, this function is enabled.

### Enabling Auto Restart

1. Tap on *Settings > System Settings > Auto Restart*.
2. Tap on the *Auto Restart* switch to activate the function.
3. To enter a value for the Restart Time parameter, tap on *Restart Time*.
4. Enter a value between 1 s and 45 min.

### Disabling Auto Restart

1. Tap on *Settings > System Settings > Auto Restart*.
2. Tap the *Auto Restart* switch to deactivate the function.

 Auto Restart is not available for the incubation function. If there are frequent power outages in the laboratory, there is the option to use the incubation function via a PCR program with one single program step.

## 7.3 Application

### 7.3.1 Opening the Program Manager

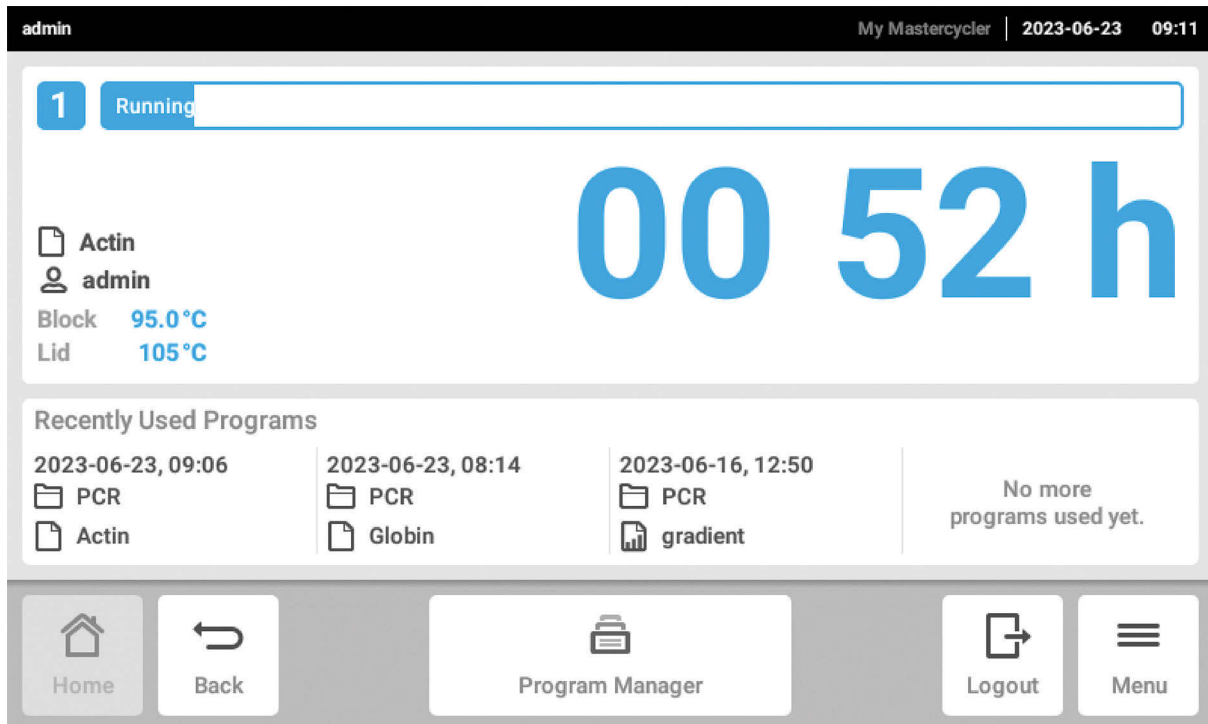

Fig. 7-2: Home screen during the execution of a PCR program

The Program Manager can be used to manage up to 5000 programs in up to 500 folders. When the user administration is enabled, all available folders and programs are displayed if the logged in user has the required user rights.

Proceed as follows to open the Program Manager:

1. On the Home screen, tap on *Menu > Program Manager*.

### 7.3.2 Creating a folder

1. Tap on *Program Manager > New > New folder*.
2. Give the folder a name. Confirm the entry.

The folder is displayed in *My folders*.

### 7.3.3 Managing folders and programs

1. Tap on *Program Manager*.
2. Navigate to the folder or program you want to edit.

3. Tap on ... next to the folder name or program name.
4. Select:
  - *Sharing* (administrator and user with default user rights): Share folder or program with other users
  - *Copy*: Duplicate folder or program
  - *Move* (administrator only): Move folder or program from *Lost and Found* to *My folders*
  - *Rename*: Rename folder or program
  - *Info*: Information on folder or program
  - *Export*: Copy folder or program to a USB drive
  - *Delete*: Delete folder or program

 Folders and programs of users that are deleted are stored in the folder *Lost and Found*. This folder is only visible to the Administrator.

### 7.3.4 Setting up programs

1. Tap on *Program Manager > New > New program*.
2. Give the program a name. Select a template in the drop-down menu. Confirm the selection.
3. Select the folder you would like to save the program in. Confirm the selection.

The program is displayed in the selected folder.
4. To edit the program, tap on the program.

The program editor opens. On the left, the overall settings are displayed and on the right the program steps are shown.
5. To add or edit steps, tap on a step.

The editing options are displayed.
6. To edit the overall program settings, tap on *Edit Settings*.

You have the following options:

  - Setting the heated lid temperature
  - Selecting the block temperature control mode
  - Limiting the heating rate
  - Limiting the cooling rate
  - Setting the run time
  - Selecting the program status
  - Entering a comment

### 7.3.5 Importing programs

 You can import programs from Mastercycler nexus and Mastercycler pro here. Controlled ramps and simulated devices will not be transferred. Incompatible programs are marked with a yellow exclamation mark.

1. Tap on *Program Manager*.
2. Navigate to the folder where you want to import folders or programs.
3. Connect a USB storage medium.
4. Tap on *Import*.

The device displays the contents of the USB storage medium.

5. Tap on the folders or programs you want to import.
6. Confirm the selection.

### 7.3.6 Administration of programs

1. Tap on *Program Manager*.
2. Navigate to the program you would like to edit.
3. Tap on the ... symbol next to the program name.
4. Select:
  - *Protect*: Protect a program (Read only or Read and write)
  - *Copy*: Duplicate a program
  - *Move*: Move the program to a different folder
  - *Rename*: Rename the program
  - *Info*: Display information about the program
  - *Export*: Copy the program to a USB drive
  - *Delete*: Delete a program



Folders and programs of users that are deleted are stored in the folder *Lost and Found*. This folder is only visible to the Administrator.

## 7.3.7 Setting the program

### 7.3.7.1 Editing program settings

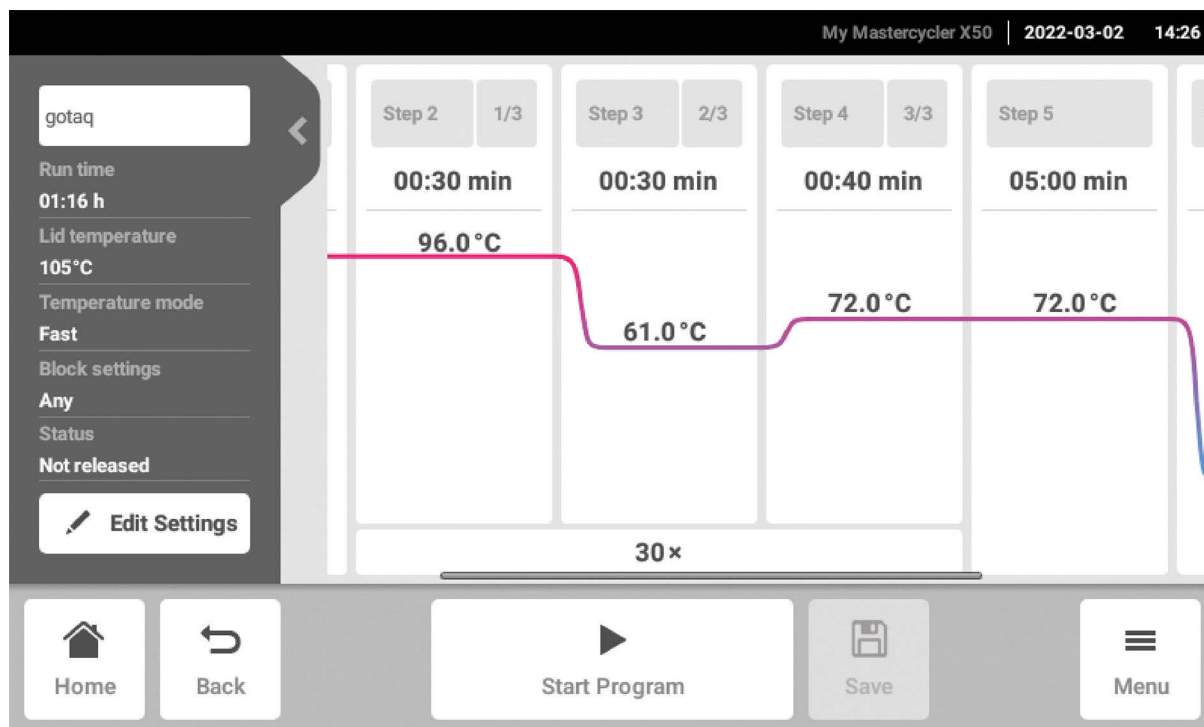

Fig. 7-3: Start screen for editing program settings

Once you have selected a program, you will see the general settings on the left and the program steps on the right.

### 7.3.7.2 Setting the lid temperature

1. Tap on *Edit Settings* > *Lid Temp.*
2. Tap on the *Lid Temperature* switch to activate the function.
3. Tap on the value and enter the heated lid temperature.
4. Tap on *Save* to save it.



#### Energy-saving mode

To save energy, activate the *Energy-saving mode* switch. If the temperature of the thermoblock is below 15 °C, the lid is no longer heated.

### 7.3.7.3 Selecting the block temperature control mode

1. Tap on *Edit Settings > Temp Mode*.
2. Tap on the recommended setting for the reaction volume:
  - *Fast*:  $\leq 10 \mu\text{L}$
  - *Intermediate*:  $10 - 20 \mu\text{L}$
  - *Standard*:  $20 - 50 \mu\text{L}$
  - *Safe*:  $\geq 50 \mu\text{L}$
3. Tap on *Save* to save it.

### 7.3.7.4 Setting the thermoblock

1. Tap on *Edit Settings > Block Settings*.
2. Tap on a block type:
  - *Any*
  - *Silver 96*
  - *Aluminum 96*
  - *Aluminum 384*
3. Tap on *Save* to save it.

### 7.3.7.5 Limiting the heating rate

1. Tap on *Edit Settings > Block Settings*.
2. Tap on the *Heating rate limit* switch to activate the function.
3. Tap on the value and enter the heating rate.
4. Tap on *Save* to save it.

 If the *Heating rate limit* function is disabled, the device automatically uses the maximum value.

### 7.3.7.6 Limiting the cooling rate

1. Tap on *Edit Settings > Block Settings*.
2. Tap on the *Cooling rate limit* switch to activate the function.
3. Tap on the value and enter the cooling rate.
4. Tap on *Save* to save it.

 If the *Cooling rate limit* function is disabled, the device automatically uses the maximum value.



### 7.3.7.7 Setting the run time

Under the run time, enter the estimated or desired run time. The estimated run time is calculated from the PCR program and the settings for the block temperature control mode, the block type and the heating and cooling rates. The desired run time is based on the activated *Desired runtime* function and the manually entered value for the run time.

1. Tap on *Edit Settings > Block Settings*.
2. Tap on the *Desired runtime* switch to activate the function.
3. Tap on the value and enter the run time.
4. Tap on *Save* to save it.

 If the *Desired runtime* function is activated, you cannot define any ramps. The device calculates the matching ramps for the run time that was entered.

### 7.3.7.8 Selecting the program status

1. Tap on *Edit Settings > Release State*.
2. Tap on a program status:
  - *Not Released*: User with restricted rights cannot use the program.
  - *Released*: All users can use the program.
3. Tap on *Save* to save it.

 Programs with the status *Released* can no longer be changed. Check programs carefully before release.

### 7.3.7.9 Entering a comment

1. Tap on *Edit Settings > Comment*.
2. Tap on the text field and enter a comment.
3. Tap on *Save* to save it.

 Comments are displayed in the log of a PCR run with this program.

## 7.3.8 Editing the program

### 7.3.8.1 Editing programs

If you have selected a program, you can see the general settings on the left and the program steps on the right.

### 7.3.8.2 Inserting a program step

1. Tap on a program step.
2. Tap on *Add step left* or *Add step right*.

**Operation**

Mastercycler® X50  
English (EN)

## 3. Select:

- *Temperature*: Individual temperature step with adjustable block temperature and holding time
- *3-Steps Cycle*: Cycle consisting of 3 temperature steps with 1 – 99 repetitions
- *2-Steps Cycle*: Cycle consisting of 2 temperature steps with 1 – 99 repetitions
- *n-Steps Cycle*: Cycle consisting of up to 40 temperature steps with 1 – 99 repetitions
- *Hold*: Temperature step with indefinite holding time. The set temperature is held until the process is resumed manually.
- *Sketch Mode*: Sketch multiple steps on the touch screen ↪ *Chapter 7.3.8.3 “Adding a program step in Sketch Mode” on page 42*

The program step is inserted.

4. To set the holding time, block temperature and number of repetitions, tap on the corresponding value.
5. To save the program step, tap on *Save*.

**7.3.8.3 Adding a program step in Sketch Mode**

1. Tap on a program step.
2. Tap on *Add step left* or *Add step right*.
3. Tap on *Sketch Mode*.

The functions are explained on the screen.

4. Add up to 6 program steps using vertical lines.
5. Use a horizontal line to set the temperature of a program step.
6. Draw a curve across several program steps to create a temperature profile.
7. Draw a circle around several program steps to create a cycle (30x).
8. Draw a cross over the program step to delete a program step.
9. Confirm your entry.

**7.3.8.4 Setting gradients****Setting gradients**

Prerequisites:

- The thermoblock is set to *Silver 96*, *Aluminum 96* or *Aluminum 384*.

1. Tap on a program step.
2. Tap on *Gradient*.
3. Select a horizontal or vertical gradient function.
4. Set the lower temperature limit under *Low Temp*.
5. Set the upper temperature limit under *High Temp*.
6. Tap on *Save* to save it.
7. Close the window.

-  The gradient temperature can be set between 30 °C and 99 °C. If a gradient temperature below 30 °C was defined, an alarm message is displayed when the program starts. The gradient spread is 30 °C max.

### 7.3.8.5 Defining increments and decrements

1. Tap on a program step.
2. Tap on *Inc./Dec.*.
3. To set a time, in the *Time* area, tap on *Increment* or *Decrement*.
4. Tap on the value and set the time by which the next cycle will be extended or shortened.
5. To set a temperature, in the *Temperature* area, tap on *Increment* or *Decrement*.
6. Tap on the value and set the temperature by which the temperature will be increased or decreased in the next cycle.
7. Tap on *Save* to save it.
8. Close the window.

-  The time increment or time decrement can be set from 00:01 – 01:00 in 1 s increments.

-  The temperature increment or temperature decrement can be set from 4 °C – 99 °C in 0.1 °C increments.

### 7.3.8.6 Defining the ramp

1. Tap on a program step.
2. Tap on *Ramp*.
3. Tap on the *Ramp Speed Limit* switch to activate the function.
4. Tap on the value and enter the ramp rate.

-  The maximum ramp rate depends on the cooling rate. You can adjust the ramp in increments of 0.1 °C.

5. Tap on *Save* to save it.
6. Close the window.

### 7.3.8.7 Deleting a program step

1. Tap on a program step.
2. Tap on the recycling bin symbol.

## 7.4 Loading the thermoblock



Very soft PCR tubes may become deformed at high temperatures. To prevent deformation:

- Increase the number of empty sample tubes in the thermoblock.
- Reduce the temperature of the heated lid.

1. To unlock the heated lid, flip up the lid handle as far as it will go.
2. Open the heated lid.
3. Place the sample tubes in the center of the thermoblock and ensure that they are positioned symmetrically.
4. If you have less than 5 samples, use additional empty sample tubes.
5. Close the heated lid.
6. To lock the heated lid, push the lid handle down as far as it will go.

## 7.5 Starting a program

Prerequisites:

- The thermoblock has been loaded.
- The heated lid is closed.

1. Tap on *Program Manager*.

You can see folders and programs in the *Program Manager*.

2. Tap on a folder.
3. Tap on a program.

The program editor is displayed.

4. Tap on *Start Program*.
5. Edit or adopt the details in the *Run identification* edit box.
6. Tap on *Confirm*.
7. If eco devices are connected, select a device.
8. Tap on *Confirm*.

The program starts.



On the home screen you can see the most recently used programs under *Recently used*. When you tap on a program, you will go straight to the Program Editor and can start the program.



If you would like to display the remaining run time larger during the PCR run, tap on the remaining run time in the program window.

## 7.6 Interrupting or aborting a program

### Interrupting a program

1. Tap the program that is currently running on the home screen.  
The program window appears.
2. Tap on *Pause*.  
The status changes to *Paused*.
3. Tap on *Resume* to resume the program.

### Aborting the program

1. Tap the program that is currently running on the home screen.  
The program window appears.
2. Tap on *Stop*.
3. Tap on *Abort Program*.

## 7.7 Incubating

 Automatic restart will not work during incubation.

You can set the *Incubate* function separately for all connected devices.

### Starting the *Incubate* function

Prerequisites:

- The thermoblock has been loaded.

1. Tap on *Menu > Incubate*.  
The available devices are displayed.
2. Set the temperature for the thermoblock.
3. Tap on the *Block* switch to activate the function.
4. Set the temperature for the heated lid.
5. Tap on the *Lid* switch to activate the function.

### Ending the *Incubate* function

1. To end the function for all devices, tap on *Stop All Incubations*.
2. To end the function for individual devices, tap on the switches for *Block* and *Lid*.

## 7.8 Accessing Events

The event log stores a maximum of 500000 user-specific and device-specific events. If there are more than 500000 entries, the oldest entries are overwritten.

### Accessing the details of an entry

1. Tap on *Menu > Events*.
2. Tap on an entry.

The details of the entry are displayed.

### Filtering Events

1. Tap on *Menu > Events*.
2. Tap on the filter symbol.
3. Select the required filter.



To deactivate all filters, tap on *Reset Filters*.

## 7.9 Opening logs

The device saves 1000 program runs. If there are more than 1000 program runs, the oldest data is overwritten.

### Calling up Run Records

1. Tap on *Menu > Run Records*.
2. Tap on an entry.

The details of the entry are displayed.

### Filtering Run Records

1. Tap on *Menu > Run Records*.
2. Tap on the filter symbol.
3. Select the required filter.



To deactivate all filters, tap on *Reset Filters*.

## 8 Maintenance

### 8.1 Maintenance plan

Interval	Maintenance work
As required	↪ Chapter 8.3.1 "Cleaning the device" on page 49
	↪ Chapter 8.3.2 "Disinfecting the device" on page 50
	↪ Chapter 8.3.3 "Cleaning the touch screen" on page 51

### 8.2 Service

Eppendorf SE recommends having your device inspected and maintained at regular intervals by trained and skilled personnel.

Eppendorf SE offers customized service solutions for preventive maintenance, qualification and calibration of your device. For information, offers and contact options, visit our website [www.eppendorf.com/epservices](http://www.eppendorf.com/epservices).

#### 8.2.1 Servicing the device

Correct temperature homogeneity and temperature accuracy of the thermoblock are essential for reliable and reproducible PCR runs. For correct temperature verification of your PCR thermoblock, specific test conditions (e.g., closed heated lid during verification) and equipment, such as the Eppendorf Temperature Verification System T6, are required. In addition, we recommend annual servicing of your device to minimize the risk of downtime, to ensure optimum performance and to extend the service life of your device.

#### 8.2.2 Checking the functionality

 The certificate can only be exported to a USB stick immediately after taking the measurement.

1. Tap on *Menu > Maintenance & Qualification > Recurring Tasks > Self Test*.
2. Tap on *Perform Task*.
3. Follow the instructions on the touch screen.  
The result will be displayed after the self test.
4. To export the result, connect a USB stick and tap on *Export*.  
The message *Export successful* appears.
5. Confirm the message to complete the process.

#### 8.2.3 Verifying the device

 The certificate can only be exported to a USB stick immediately after taking the measurement.

Tool:

- Temperature Verification System, single channel

Prerequisites:

- You have standard rights.
- Keep the heated lid closed during verification.

1. Tap on *Menu > Maintenance & Qualification > Recurring Tasks > Verification*.
2. Tap on *Perform Task*.
3. Follow the instructions on the touch screen.  
The result will be displayed after verification.
4. To export the result, connect a USB stick and tap on *Export*.  
The message *Export successful* appears.
5. Confirm the message to complete the process.

#### 8.2.4 Data export

You can export Events and system information to a USB stick.

1. Connect a USB stick.
2. Tap on *Menu > Export*.
3. Select which data is to be exported.
4. Tap on *Export*.
5. Confirm the export.

 You can set the level of detail for logs. Tap on *Settings > System Settings > Protocol Level*. Activate or deactivate the function *Export detailed program run protocol*.

#### 8.2.5 Updating software

 Devices that are not connected to the VisioNize Lab Suite can only be updated by an authorized service technician. Contact your local Eppendorf partner.



##### **NOTICE! Damage to device**

If you interrupt the installation of the software update the device is no longer functional. The software must be reinstalled by a service technician.

- Wait until the software installation is complete and the device has restarted.

Eppendorf regularly provides software updates. If the device is connected to the VisioNize Lab Suite, you will be notified on screen as soon as a software update is available.



1. To install the software update, tap on *Install now*.

## 8.3 Cleaning

### 8.3.1 Cleaning the device

#### Cleaning the inside of the device



#### **DANGER! Electric shock**

If you touch any parts which are under voltage, you may experience an electric shock. Electric shocks cause heart injury and respiratory paralysis.

- Switch off the device and disconnect the mains/power plug before commencing work on the device.



#### **DANGER! Electric shock**

If liquids get inside the device, users may suffer an electric shock. A fatal electric shock causes cardiac arrhythmia and respiratory paralysis.

- Switch off the device and disconnect it from the mains/power line before starting cleaning or disinfection.
- Do not allow any liquids to enter the inside of the housing.
- Do not spray the device.
- Do not connect the device to the mains/power line unless both the inside and outside of the device are completely dry.



#### **NOTICE! Damage to assembly**

Liquids that ingress the device interior can cause corrosion on the electronic components. This will impair the function of the device.

- Do not spray liquids directly onto plugs and into openings of the device.
- Only moderately spray the surfaces with liquids.

-  Do not use ionizing or UV radiation for cleaning.

#### Material:

- Water
- pH-neutral soap
- Cloth

#### Prerequisites:

- The device is disconnected from the mains/power line.
- The device has cooled down.

1. Dampen a lint-free cloth with water and cleaning agent.
2. Open the heated lid.
3. Remove any contamination on the bottom of the heated lid.

4. Remove any labeling residue from tube lids on the bottom of the heated lid using ethanol or isopropanol.
5. Remove any contamination on the thermoblock.



Even small deposits of dust and lint will affect the heat transfer between the thermoblock and the tubes.

### Cleaning the outside of the device

Material:

- Water
- pH-neutral soap
- Cloth

1. Dampen a lint-free cloth with water and cleaning agent.
2. Clean the exterior surfaces of the device.

### 8.3.2 Disinfecting the device



#### **DANGER! Electric shock**

If you touch any parts which are under voltage, you may experience an electric shock. Electric shocks cause heart injury and respiratory paralysis.

- Switch off the device and disconnect the mains/power plug before commencing work on the device.



#### **DANGER! Electric shock**

If liquids get inside the device, users may suffer an electric shock. A fatal electric shock causes cardiac arrhythmia and respiratory paralysis.

- Switch off the device and disconnect it from the mains/power line before starting cleaning or disinfection.
- Do not allow any liquids to enter the inside of the housing.
- Do not spray the device.
- Do not connect the device to the mains/power line unless both the inside and outside of the device are completely dry.



#### **NOTICE! Damage to components**

If disinfectant gets inside the device, it can cause electronic components to corrode. This will impair the function of the device.

- Only spray disinfectant onto a cloth.



Do not use ionizing or UV radiation for cleaning.

Material:

- Disinfectant with at least 70 % ethanol
- Cloth

Prerequisites:

- The device is disconnected from the mains/power line.
- The device has cooled down.

1. Dampen a lint-free cloth with disinfectant.
2. Wipe all parts of the device with the cloth.

### 8.3.3 Cleaning the touch screen

Material:

- Soap-based cleaning agent
- Disinfectant with at least 70 % ethanol
- Cloth

1. Tap on *Menu > Clean Screen*.

The touch screen is locked.

2. Dampen the cloth with cleaning agent or disinfectant.
3. Clean the touch screen.
4. To unlock the touch screen, tap the corners of the touch screen in the given order.

The touch screen is unlocked.

## 9 Troubleshooting

### 9.1 Processing messages



Once the fault is eliminated, all signals will cease. Only the text of the message will appear in the notification bar until the message was acknowledged.

1. To disable the audio signal, tap on the speaker icon in the message bar.

If the fault is not eliminated after 5 min, the audio signal will be emitted again.

2. To access the message, tap on the message bar.
3. Eliminate the fault.
4. Tap on the cross icon to acknowledge the message.

The message is deleted from the message bar. After all messages have been acknowledged, the message bar will be hidden. The status bar appears.

### 9.2 Entering contact details

Information on your Eppendorf partners can be entered in this area.

1. Tap on *Menu > Contacts & Support > Contacts*.
2. Tap on *Add Contact*.
3. Enter the name of the Eppendorf partner.
4. Confirm the entry.
5. Enter all desired information about the Eppendorf partner.

### 9.3 Accessing service information

In this area, you can access device information for communication with the authorized service.

1. Tap on *Menu > Contact & Support > Diagnostics > Service Information*.
2. Pass the information on to the authorized service.

## **10 Shut down**

### **10.1 Switching off the device**

 Programs on connected Eco devices will continue to run when you switch off the Master device.

1. Switch off the mains/power switch.
2. Disconnect the mains/power plug from the earth/grounded socket.
3. Remove the IEC connector at the rear of the device.

### **10.2 Disconnecting the device from the mains/power supply**

1. Switch off the mains/power switch.
2. Place an empty plate on the thermoblock.
3. To prevent contamination of the thermoblock, close the heated lid and fold the handle forward.
4. Pull the mains plug from the socket.
5. Remove the IEC connector at the rear of the device.

## 11 Transport

### 11.1 Preparing the device for transport

#### Prerequisites

- The device is out of operation.
  - The device has been cleaned and decontaminated.
1. Ensure that there is no condensate in the thermoblock.
  2. Load the thermoblock with an empty PCR plate.
  3. Close the heated lid.

### 11.2 Transporting the device



#### **CAUTION! Personal injury**

Lifting the device by the handle may cause the handle to break. The device may fall down and cause injuries.

- Lift the device by placing your hands under the housing.

#### Prerequisites:

- A sufficient number of helpers are available to assist with transportation.
1. Transport the device in an upright position. Use a transport aid for this, such as a mobile table.
  2. Avoid shaking the device.

### 11.3 Shipping the device



Use the original packing to transport the device. If the original packing is no longer available, please ensure that the device is sufficiently protected by replacement packing during storage and further transport. Eppendorf SE is not liable for damage caused by improper replacement packing.



#### **WARNING! Contamination**

Shipping or storing a contaminated device may lead to contamination of persons or cause damage to health.

- Clean and decontaminate the device before shipping it or putting it into storage.

Material:

- Packing

Prerequisites:

- The device has been taken out of operation.
  - The device has been cleaned and decontaminated.
1. Download the decontamination certificate for product returns from the webpage [www.eppendorf.com](http://www.eppendorf.com).
  2. Complete the decontamination certificate.
  3. Pack the device.
  4. Attach the decontamination certificate to the outside of the packing so that it is safe for transport.
  5. Ship the device.

## 12 Storage

### 12.1 Preparing the device for storage

 If the original packing is not available, order the original packing.

Material:

- Packing

Prerequisites

- The device has been taken out of operation.
  - The device has been cleaned and decontaminated.
1. Ensure that there is no condensate in the thermoblock.
  2. Load the thermoblock with an empty PCR plate.
  3. Close the heated lid.
  4. Pack the device.



## 13 Disposal

### 13.1 Legal requirements

#### EU countries

In the EU member states, electrical and electronic equipment must be disposed of in accordance with Directive 2012/19/EU. This directive has been transposed into national law by all EU member states.

Electrical and electronic equipment which has been put on the market after August 13, 2005 must be marked in a special way. According to the European standard DIN EN 50419 the following symbol can be used to mark this equipment:

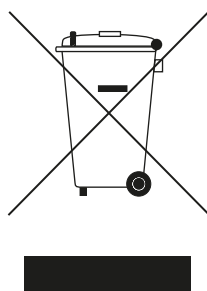



In the EU member states, batteries and rechargeable batteries must be disposed of in accordance with Directive 2006/66/EC. This directive has been transposed into national law by all EU member states.

#### Non-EU countries

Non-EU countries have country-specific standards for the disposal of waste electrical and electronic equipment and the disposal of batteries and rechargeable batteries.

### 13.2 Preparing for disposal

#### Preparing disposal in accordance with legal regulations

-  For information on the legal regulations that apply in your country, please contact your local competent authority or your Eppendorf partner.
  
-  Dispose of non-decontaminable devices as hazardous waste.

1. Check which legal regulations apply to disposal in your country.
2. Choose a certified disposal company or contact your Eppendorf partner.

### **Creating a decontamination certificate**

Prerequisites:

- The device has been decontaminated.
1. Download a decontamination certificate from our webpage [www.eppendorf.com](http://www.eppendorf.com).
  2. Complete the decontamination certificate.

### **13.3 Handing over the device to the disposal company**

1. Inform the disposal company of any hazards posed by the device, e.g., locking devices, flammable substances.
2. Hand over the device and the decontamination certificate to the certified disposal company.

## 14 Technical data

### 14.1 Dimensions

Width	275 mm
Depth	430 mm
Height with lid closed	330 mm
Height with lid open	439 mm

### 14.2 Weight

Mastercycler X50	11,5 kg
Mastercycler X50 eco	10,7 kg

### 14.3 Mains/power supply

Mains/power supply voltage	100 V – 240 V ± 10 %
Mains/power frequency	50 Hz – 60 Hz
Power consumption	850 W max.
Overvoltage category	II
Pollution degree	2
Protection class	I
Specifications for mains/power cords in Europe with E/F mains/power plugs	Cable type AC 250 V / 10 A 3G 1 mm <sup>2</sup> with double insulation  Mains/power plug according to IEC EEI CEE-7 / IEC 60884-1 and C13 appliance coupler according to IEC 60320-1
Specifications for mains/power cords in Europe with other mains/power plugs	Use the mains/power cord in accordance with national regulations  Cable type AC 250 V / 10 A 3G 1 mm <sup>2</sup> with C13 appliance coupler according to IEC 60320-1 and with mains/power plug according to national regulations and IEC 60884-1
Specifications for mains/power cords in Canada and the USA	Cable type AC 125 V / 10 A SJT 3x18 AWG with double insulation  Mains/power plug NEMA 5-15 according to ANSI/NEMA WD-6 and C13 appliance coupler according to UL/IEC 60320-1
Specifications for mains/power cords outside Europe, Canada and the USA	Use the mains/power cord in accordance with national regulations

## 14.4 Ambient conditions

### Operation

Environment	For indoor use only. Not a wet environment.
Ambient temperature	15 °C – 35 °C
Relative humidity	75 % maximum
Atmospheric pressure	80 kPa max.

### Transport

Air temperature	-25 °C – 60 °C
Air temperature for air freight	-40 °C – 55 °C
Relative humidity	10 % – 95 %
Atmospheric pressure	30 kPa – 106 kPa

### Storage

Air temperature	-20 °C – 70 °C
Relative humidity	10 % – 95 %

## 14.5 Electromagnetic compatibility

Electromagnetic compatibility	IEC 61326-1, Class B  Class B is the basic electromagnetic environment (environment at locations which are directly supplied with low voltage from the public supply network)
-------------------------------	---

## 14.6 Interfaces

### Interfaces of the Mastercycler X50

USB	1x 2.0 Type A
Ethernet	<ul style="list-style-type: none"> <li>• 1x RJ-45 plug for connection to the VisioNize Lab Suite (main cyclor)</li> <li>• 1x RJ-45 plug for Cyclor network</li> <li>• Compatibility with IEEE 802.3 Ethernet switch at a data transfer rate of 10/100 MBit/s or 10/100/1000/... MBit/s</li> </ul>

## 14.7 Noise level

The noise level was measured in a method using an enveloped surface with accuracy class 2 (DIN EN ISO 3744) at a distance of 1 m to the device for a sound field that is substantially free of obstacles above a reflective plane.

Idle: continuous idle state	< 31.2 dB(A)
Default PCR execution (temperature control cycle)	< 33.6 dB(A)
Continuous cooling cycle at 4° C	< 47.2 dB(A)

## 14.8 Application parameters

### Mastercycler X50a, Mastercycler X50l (eco)

Thermoblock	Aluminum 96 wells
Sample capacity	<ul style="list-style-type: none"> <li>• 96 × 0.1 mL PCR tubes</li> <li>• 96 × 0.2 mL PCR tubes</li> <li>• 1x 96-well PCR plate (unskirted, semi-skirted, skirted and low-profile)</li> </ul>
Temperature control range of the thermoblock	4 °C – 99 °C
Ramp rate (heating) (measured on the thermoblock)	max. 5 °C/s
Ramp rate (cooling) (measured on the thermoblock)	max. 2.3 °C/s
Temperature homogeneity of the thermoblock (with gradient function switched off) at 20 °C – 72 °C at 72 °C – 95 °C	±0,2 °C ±0,3 °C
Control accuracy (with gradient function switched off)	±0,15 °C
Gradient spread (horizontal and vertical)	30 °C max.
Gradient temperature control range (horizontal and vertical)	30 °C – 99 °C
Heated lid temperature control range	37 °C – 110 °C

### Mastercycler X50h, Mastercycler X50t (eco)

Thermoblock	Aluminum 384 wells
Sample capacity	1x 384-well PCR plate
Temperature control range of the thermoblock	4 °C – 99 °C

**Technical data**  
 Mastercycler® X50  
 English (EN)

Ramp rate (heating) (measured on the thermoblock)	max. 5 °C/s
Ramp rate (cooling) (measured on the thermoblock)	max. 2.3 °C/s
Temperature homogeneity of the thermoblock (with gradient function switched off) at 20 °C – 72 °C at 72 °C – 95 °C	±0,2 °C ±0,3 °C
Control accuracy (with gradient function switched off)	±0,15 °C
Gradient spread (horizontal and vertical)	30 °C max.
Gradient temperature control range (horizontal and vertical)	30 °C – 99 °C
Heated lid temperature control range	37 °C – 110 °C

**Mastercycler X50s, Mastercycler X50i (eco)**

Thermoblock	Silver 96 wells
Sample capacity	<ul style="list-style-type: none"> <li>• 96 × 0.1 mL PCR tubes</li> <li>• 96 × 0.2 mL PCR tubes</li> <li>• 1x 96-well PCR plate (unskirted, semi-skirted, skirted and low-profile)</li> </ul>
Temperature control range of the thermoblock	4 °C – 99 °C
Ramp rate (heating) (measured on the thermoblock)	max. 10 °C/s
Ramp rate (cooling) (measured on the thermoblock)	max. 5 °C/s
Temperature homogeneity of the thermoblock (with gradient function switched off) at 20 °C – 72 °C at 72 °C – 95 °C	±0,2 °C ±0,3 °C
Control accuracy (with gradient function switched off)	±0,15 °C
Gradient spread (horizontal and vertical)	30 °C max.
Gradient temperature control range (horizontal and vertical)	30 °C – 99 °C
Heated lid temperature control range	37 °C – 110 °C

## 15 Glossary

### **Adjustment**

Adjustments are performed to eliminate or reduce the systematic error of a device. Adjustments involve interventions that permanently change the device.

### **Events**

Software function that records event logs.

### **Residual current circuit breaker**

Protective device that disconnects the voltage when there is a dangerously high rated residual current flowing to ground. Residual current circuit breakers protect persons from electric shock.

### **Verification**

Objective demonstration of the compliance with the defined specifications.

### **VisioNize**

System for laboratory monitoring offered by Eppendorf SE, providing services related to Eppendorf devices.

## 16 Index

### A

Authorized service . . . . .	52
Authorized service technician . . . . .	10

### D

Decontamination certificate . . . . .	54
Device	
Noise level . . . . .	61
Disposal . . . . .	57

### E

Event log . . . . .	32, 46
---------------------	--------

### L

Log . . . . .	32, 46
---------------	--------

### M

Manual	
Symbols . . . . .	6

### O

Owner . . . . .	10, 11
Profile . . . . .	10

### P

Packing	
Original packing . . . . .	54

Replacement packing . . . . .	54
-------------------------------	----

Password . . . . .	28
Change password . . . . .	29
Lost password . . . . .	26

PIN . . . . .	28
Change PIN . . . . .	29
Lost PIN . . . . .	26

### program

abort a program . . . . .	45
interrupt a program . . . . .	45
pause a program . . . . .	45
resume a program . . . . .	45

Protective clothing . . . . .	11
-------------------------------	----

### S

#### Safety

Protective clothing . . . . .	11
Warning notice structure . . . . .	6

### T

Technical personnel . . . . .	10
Touchscreen . . . . .	33

### U

User . . . . .	10, 30
----------------	--------

### W

#### Warning notice

Structure . . . . .	6
---------------------	---





# Evaluate Your Manual

Give us your feedback.

[www.eppendorf.com/manualfeedback](http://www.eppendorf.com/manualfeedback)

**Your local distributor: [www.eppendorf.com/contact](http://www.eppendorf.com/contact)**

Eppendorf SE · Barkhausenweg 1 · 22339 Hamburg · Germany

[eppendorf@eppendorf.com](mailto:eppendorf@eppendorf.com) · [www.eppendorf.com](http://www.eppendorf.com)