



Centrifuge 5424 / 5424 R

Operating manual



Register
your instrument!

www.eppendorf.com/myeppendorf

*my*eppendorf

eppendorf



Copyright © 2009 Eppendorf AG, Hamburg. No part of this publication may be reproduced without the prior permission of the copyright owner.

Trademarks

eppendorf is a registered trademark of Eppendorf AG, Hamburg, Germany.

Microtainer is a registered trademark of Becton Dickinson, Franklin Lakes, NJ, USA.

Trademarks are not marked in all cases with TM or ® in this manual.



Your Online Product Registration
Register your Eppendorf instruments online and get rewarded!
Learn more: www.eppendorf.com/myeppendorf
Not available in all countries.

Operating manual 5
Declarations and Certificates 176

You will find a detailed description of these figures in your language in Chapters 1.1/2.1 and 4.1/5.1.

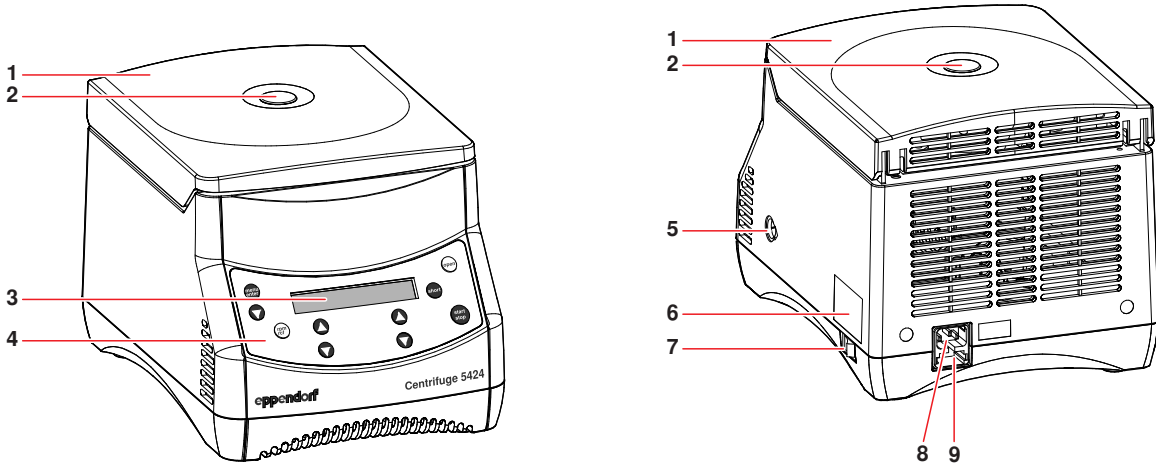

Fig. 1: Front and rear view of the Centrifuge 5424

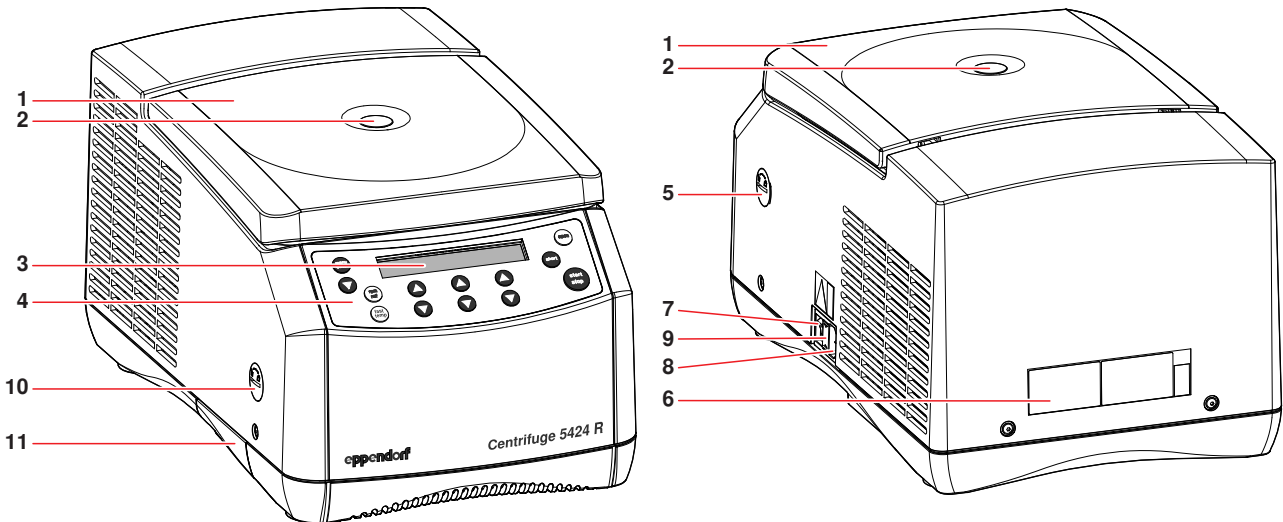

Fig. 2: Front and rear view of the Centrifuge 5424 R

1 Centrifuge lid	2 Window
3 Display	4 Control panel
5 Emergency release	6 ID plate
7 Mains switch	8 Power connection
9 Fuse holder	10 USB port (only 5424 R, only for technical support)
11 Condensation water tray (only 5424 R)	

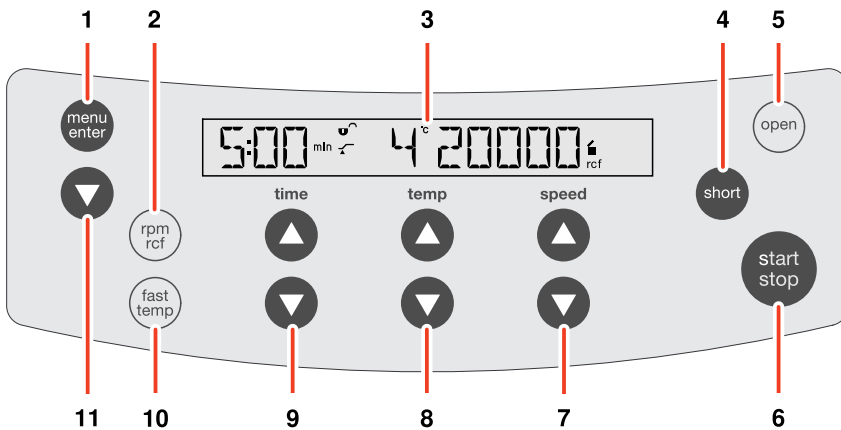

Fig. 3: Control panel of the Centrifuge 5424 / 5424 R

1 Call and select the menu parameters	2 Switch the centrifuging speed displayed (rpm/rcf)
3 Display	4 Short Spin centrifugation
5 Release lid	6 Start and stop centrifugation
7 Set the speed of centrifugation Dependent on device version designed as a key or dial.	8 Adjust the temperature (only 5424 R)
9 Adjust the centrifuging duration Dependent on device version designed as a key or dial.	10 Start the temperature control run fast temp (only 5424 R)
11 Select the menu item	

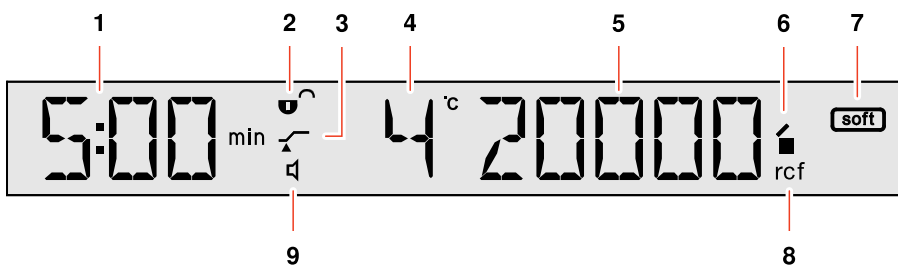

Fig. 4: Display of the Centrifuge 5424 / 5424 R

1 Centrifuging duration	2 Status of the key lock (LOCK)
3 Status of the function ATSET	4 Temperature (only 5424 R)
5 g-force (rcf) or speed (rpm)	6 Status of the centrifuge
7 Soft ramp	8 Status of the centrifugation speed display
9 Status of the loudspeaker	

Table of contents

1	User instructions	7
1.1	Using this manual	7
1.2	Warning signs and hazard icons	7
1.2.1	Hazard symbols	7
1.2.2	Degrees of danger	7
1.3	Abbreviations used	7
2	Product description	8
2.1	Main illustration	8
2.2	Delivery package	9
2.2.1	Centrifuge 5424	9
2.2.2	Centrifuge 5424 R	9
2.3	Features	9
2.4	Rotors	10
2.4.1	Rcf display and calculation	11
3	Safety	12
3.1	Intended use	12
3.2	User profile	12
3.3	Application limits	12
3.3.1	Declaration concerning the ATEX directive (94/9/EC)	12
3.3.2	Maximum service life for accessories	12
3.4	Information on product liability	13
3.5	Warnings for intended use	13
3.5.1	Personal injury or damage to the equipment	13
3.5.2	Incorrect handling of the centrifuge	14
3.5.3	Incorrect handling of the rotors	14
3.5.4	Extreme strain on the centrifuging tubes	15
3.5.5	Aerosol-tight centrifugation	16
3.6	Safety instructions on the device	16
4	Installation	17
4.1	Selecting the location	17
4.2	Installing the instrument	17
5	Operation	18
5.1	Overview of operating controls	18
5.2	Device menu	20
5.3	Menu navigation	21
5.4	Preparing for centrifugation	21
5.4.1	Switch on centrifuge	21
5.4.2	Inserting the rotor	21
5.4.3	Load the rotor	21
5.4.4	Close centrifuge lid	23
5.5	Cooling (only 5424 R)	23
5.5.1	Temperature adjustment	23
5.5.2	Temperature display	23
5.5.3	Temperature monitoring	23
5.5.4	Fast Temp	23
5.5.5	Continuous cooling	24
5.6	Centrifuging	24
5.6.1	Centrifuging with time preset	25
5.6.2	Centrifuging in continuous operation	25
5.6.3	Short spin centrifugation	26
5.6.4	Removing the rotor	26

Table of contents

6	Maintenance	27
6.1	Prepare cleaning / disinfection	27
6.2	Perform cleaning / disinfection	27
6.2.1	Clean / disinfect device	28
6.2.2	Clean / disinfect rotor	28
6.3	Additional service instructions for Centrifuge 5424 R	29
6.4	Glass breakage	29
6.5	Fuses	29
6.6	Decontamination before shipping	29
7	Troubleshooting	30
7.1	General errors	30
7.2	Error messages	31
7.3	Emergency release	32
8	Transport, storage and disposal	33
8.1	Transport	33
8.2	Storage	33
8.3	Disposal	33
9	Technical data	34
9.1	Power supply	34
9.2	Ambient conditions	34
9.3	Weight / dimensions	35
9.4	Application parameters	35
9.4.1	Centrifuge 5424	35
9.4.2	Centrifuge 5424 R	36
10	Ordering information	37
10.1	Centrifuge 5424	37
10.2	Centrifuge 5424 R	37
10.3	Accessories	38
10.3.1	Rotors and rotor lids	38
10.3.2	Adapters	38
10.3.3	Other accessories	38
10.4	Fuses	38

1 User instructions







1.1 Using this manual

- ▶ Please read this operating manual completely before using the device for the first time.
- ▶ Please view this operating manual as part of the product and keep it somewhere easily accessible.
- ▶ When passing the device on to third parties, be sure to include this operating manual.
- ▶ If this manual is lost, please request another one. The current version can be found on our website www.ependorf.com.

The Centrifuge 5424 / 5424 R is available in two versions: **keypad** or **rotary knobs**. This operating manual generally describes how to operate the keypad version. However, it also applies to the rotary knob version.

1.2 Warning signs and hazard icons

1.2.1 Hazard symbols

	Biohazard		Explosion
	Electric shock		Crushing
	Hazard point		Material damage

1.2.2 Degrees of danger

The degree of danger is a part of a safety note and distinguishes the possible results of non-observance from each other.

DANGER	<i>Will</i> lead to severe injuries or death.
WARNING	<i>May</i> lead to severe injuries or death.
CAUTION	May lead to light to moderate injuries.
NOTICE	May lead to material damage.

1.3 Abbreviations used

PCR	Polymerase chain reaction
PTFE	Polytetrafluorethylen
rcf	Relative centrifugal force
rpm	Revolutions per ^{minute}
UV	Ultraviolet radiation

2 Product description

2.1 Main illustration

The depiction of the Centrifuge 5424 / 5424 R can also be found on the front fold-out page (see Fig. 1 and Fig. 2).

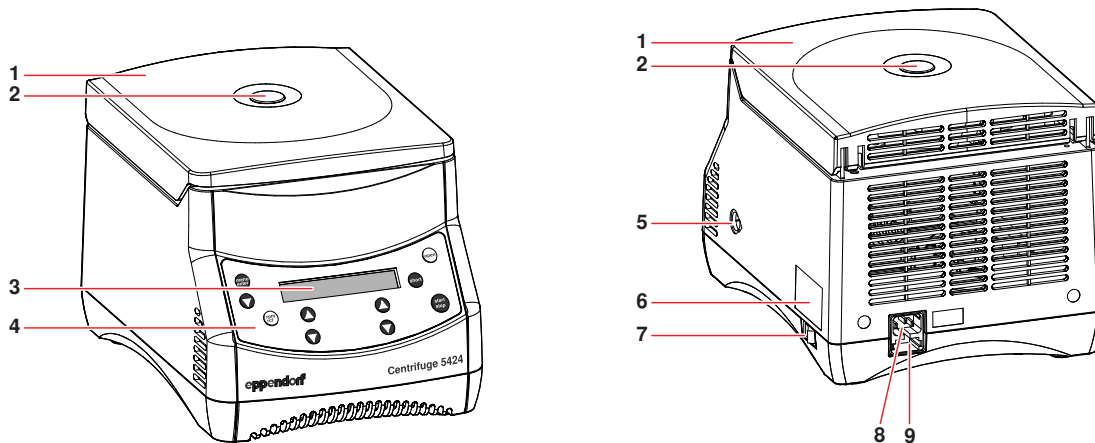

Fig. 1: Front and rear view of the Centrifuge 5424

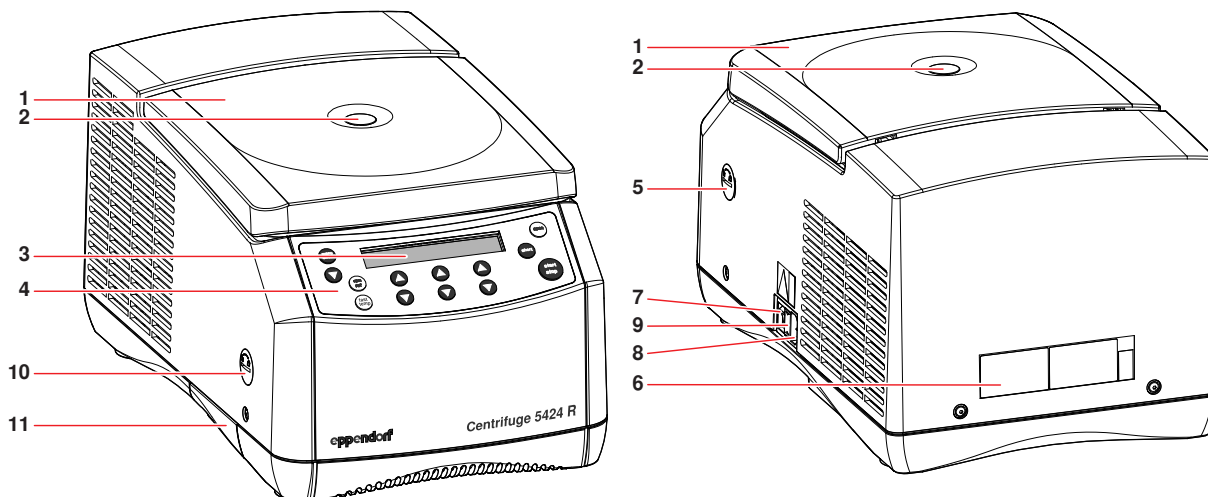

Fig. 2: Front and rear view of the Centrifuge 5424 R

<p>1 Centrifuge lid</p>	<p>2 Monitoring glass Visual control for rotor stop or option for speed control via stroboscope.</p>
<p>3 Display Depiction of the current centrifuging parameters and device settings (see Fig. 4 on p. 19).</p>	<p>4 Control panel Keys and dials (dependent on the device version) for operating the centrifuge (see Fig. 3 on p. 18).</p>
<p>5 Emergency lid release (see <i>Emergency release</i> on p. 32)</p>	<p>6 ID plate</p>
<p>7 Mains switch Switch for switching the device on and off. Switch position 0: The device is switched off. Switch position I: The device is switched on.</p>	<p>8 Mains connection Connection socket for the mains cable supplied.</p>
<p>9 Fuse holder</p>	<p>10 USB port (only 5424 R) Interface for error analysis and software updates by the Technical Service.</p>
<p>11 Condensation water tray (only 5424 R)</p>	

2 Product description

2.2 Delivery package

2.2.1 Centrifuge 5424

Quantity	Order No. (International)	Order No. (North America)	Description
1	-	-	Centrifuge 5424 See chapter <i>Ordering Information</i> for corresponding device version, equipment and order number
1 or	5424 852.122 5424 852.130	950004266 950004240	Fuses 3.15 AT for 230 V, 2 pieces 6.3 AT for 120 V/100 V, 2 pieces
1	5416 301.001	022634305	Rotor key Standard
1	5703 350.102	022639609	Captain Eppi rotor key holder 1 piece
1	-	-	Power cable
1 1	5404 900.023 5404 900.031	5404900023 5404900031	Operating manual Centrifuge 5424/5424 R Languages: EN, DE, FR, ES, IT, PT Languages: DA, FI, EL, NL, SV (230 V devices only)

2.2.2 Centrifuge 5424 R

Quantity	Order No. (International)	Order No. (North America)	Description
1	-	-	Centrifuge 5424 R See chapter <i>Ordering Information</i> for corresponding device version, equipment and order number
1 or	5424 852.122 5424 852.130	950004266 950004240	Fuses 3.15 AT for 230 V, 2 pieces 6.3 AT for 120 V/100 V, 2 pieces
1	5416 301.001	022634305	Rotor key Standard
1	-	-	Power cable
1	5404 850.085	5404850085	Tray for condensation water
1 1	5404 900.023 5404 900.031	5404900023 5404900031	Operating manual Centrifuge 5424/5424 R Languages: EN, DE, FR, ES, IT, PT Languages: DA, FI, EL, NL, SV (230 V devices only)

2.3 Features

The versatile Centrifuge 5424 / 5424 R has a capacity of 24 x 2 mL and reaches a maximum of 21,130 x g / 15,000 rpm (5424: 120 V, 5424 R: 230 V, 120 V, 100 V) or 20,238 x g / 14,680 rpm (5424: 230 V, 100 V). You can select between four different rotors to centrifuge the following tubes for your various applications:

- Micro test tubes (0.2 to 2.0 mL)
- PCR strips
- Microtainers (0.6 mL)
- Spin columns (1.5/2.0 mL)

The Centrifuge 5424 R has an additional temperature control function for centrifugation between -10°C and +40°C. The **fast temp** function can be used to start a temperature control run without samples to adjust the rotor chamber quickly to the set target temperature.

2 Product description

2.4 Rotors

You can operate the Centrifuge 5424 / 5424 R with the following rotors. Before use of sample tubes, please note the manufacturer's specifications with regard to centrifugation resistance (max. rcf).

	Max. capacity	Max. g-force (rcf) / speed (rpm) without adapter (5424: 120 V, 5424 R)	Max. g-force (rcf) or speed (rpm) without adapter (5424: 230 V/100 V)	Notes
		Max. load per rotor bore ⁽¹⁾		
Rotor FA-45-24-11	24 micro test tubes of 1.5/2.0 mL each or spin columns. With adapters: <ul style="list-style-type: none"> • 0.2 mL PCR tubes • 0.4 mL/0.5 mL micro test tubes • 0.6 mL Microtainers 	21,130 x g / 15,000 rpm	20,238 x g / 14,860 rpm	<ul style="list-style-type: none"> • Aerosol-tight⁽²⁾ rotor lid (aluminum). • Spin columns possible, better with rotor F-45-18-11-Kit.
Rotor FA-45-24-11-Special	24 micro test tubes of 1.5/2.0 mL each or spin columns. With adapters: <ul style="list-style-type: none"> • 0.2 mL PCR tubes • 0.4 mL/0.5 mL micro test tubes • 0.6 mL Microtainers 	21,130 x g / 15,000 rpm	20,238 x g / 14,860 rpm	<ul style="list-style-type: none"> • Aerosol-tight⁽²⁾ rotor lid (aluminum). • PTFE-coated (particularly resistant to chemicals), marked: <i>coated</i> • Spin columns possible, better with rotor F-45-18-11-Kit.
Rotor F-45-18-11-Kit	18 spin columns or 1.5/2.0 mL micro test tubes. With adapters: <ul style="list-style-type: none"> • 0.2 mL PCR tubes • 0.4 mL/0.5 mL micro test tubes • 0.6 mL Microtainers 	18,111 x g / 15,000 rpm	17,347 x g / 14,860 rpm	<ul style="list-style-type: none"> • Particularly high edge for all commercially available spin columns. See the note about centrifugation with open tube lids in this regard (see <i>Load the rotor on p. 21</i>).
Rotor F-45-32-5-PCR	Four PCR strips of 5/8 or 32 PCR tubes of 0.2 mL each.	18,615 x g / 15,000 rpm	17,829 x g / 14,860 rpm	
		3.5 g		

(1) Maximum load per rotor bore for adapter + tube + content.

(2) Aerosol tightness tested and certified by the Centre for Emergency Preparedness and Response, Health Protection Agency, Porton Down (UK) (see certificates at the end of this operating manual).

For the rotors and rotor lids labeled *coated*, color fluctuations may occur as a result of the production process. These fluctuations have no effect on service life or resistance to chemicals.

Rotor code:

All Eppendorf® rotors are identified using a simple, alphanumeric format that represents the technical specifications in a uniform series of letters and numbers.

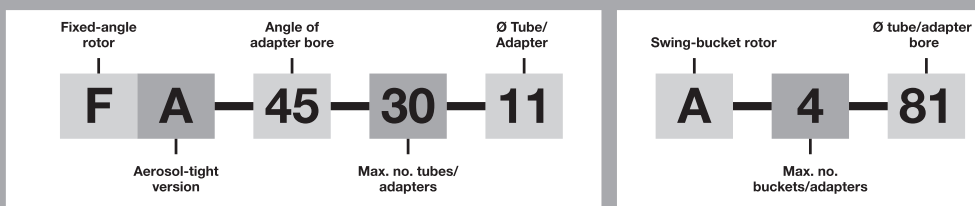

2 Product description

2.4.1 Rcf display and calculation



Use the **rpm/rcf** key to switch the display of centrifugation speed between **speed** (rpm) and **g-force** (rcf). Ensure that the g-force displayed upon switching is standardized to suit the rotor FA-45-24-11 without an adapter. When other rotors and adapters are used, you can achieve the following maximum g-forces (rcf) at the maximum speed (see p. 10):

Rotor	Adapters	Max. centrifugation radius r_{\max} [cm]	Max. g-force (rcf) (5424 120 V, 5424 R)	Max. g-force (rcf) (5424 230 V/100 V)
FA-45-24-11, FA-45-24-11-Special	without adapter	8.4	21,130	20,238
	0.2 mL	6.3	15,848	15,179
	0.4 mL	8.4	21,130	20,238
	0.5 mL	7.3	18,363	17,558
	0.6 mL	8.4	21,130	20,238
F-45-18-11-Kit	without adapter	7.2	18,111	17,347
	0.2 mL	5.1	12,829	12,288
	0.4 mL	7.2	18,111	17,347
	0.5 mL	6.1	15,345	14,697
	0.6 mL	7.2	18,111	17,347
FA-45-32-5-PCR	without adapter	7.4	18,615	17,829

To determine the g-force (rcf) for a specific adapter, you can calculate per DIN 58 970 using the following formula:

$$\text{rcf} = 1.118 \cdot 10^{-5} \cdot n^2 \cdot r_{\max}$$

n: revolutions per minute (rpm)

r_{\max} : max. centrifuging radius in cm

Example

In rotor FA-45-24-11, the 0.5 mL adapter has a maximum radius of 7.3 cm. At 7,000 rpm a maximum g-force of 4,000 x g is reached.

3 Safety

3.1 Intended use

The Centrifuge 5424 / 5424 R is intended exclusively for indoor use and for separating aqueous solutions and suspensions of various densities in approved test tubes.



CAUTION!

Poor safety due to incorrect accessories and spare parts.

The use of accessories and spare parts other than those recommended by Eppendorf may impair the safety, functioning and precision of the device. Eppendorf cannot be held liable for any damage resulting from the use of non-recommended accessories and spare parts or from the improper use of such equipment.

- ▶ Only use accessories and original spare parts recommended by Eppendorf.

3.2 User profile

This device may only be operated by correspondingly trained specialist staff. This staff must have carefully read the operating manual and be familiar with the function of the device.

3.3 Application limits

3.3.1 Declaration concerning the ATEX directive (94/9/EC)



DANGER!

Danger of explosion!

- ▶ Do not operate the device in areas where work is being carried out with explosive substances.
- ▶ Do not use this device to process any explosive, radioactive or highly reactive substances.
- ▶ Do not use this device to process any substances which could create an explosive atmosphere.

Due to its design and the environmental conditions on the inside of the device, the Centrifuge 5424 / 5424 R is not suitable for use in a potentially explosive atmosphere.

The device must therefore only be used in a safe environment, such as in the open environment of a ventilated laboratory or an extractor hood. The use of substances which may contribute to a potentially explosive atmosphere is not permitted. The final decision with regard to the risks connected with the use of such substances is the responsibility of the user.

3.3.2 Maximum service life for accessories



CAUTION!

Risk of injury from chemically or mechanically damaged accessories.

Even small scratches and cracks can lead to serious internal material damage.

- ▶ Protect all parts from mechanical damage.
- ▶ Check accessories regularly.
- ▶ Do not use rotors or buckets with signs of corrosion or mechanical damage (e.g. deformations).
- ▶ Do not use accessories whose maximum service life has been exceeded.

Accessory	Maximum service life from first commissioning
Transparent polypropylene rotor lids	3 years
Plastic adapters	1 year

3 Safety

For the other rotors and rotor lids of this centrifuge (see *Rotors on p. 10*) there is no limit for their service life, as long as the following conditions are met: proper use, recommended maintenance and undamaged condition. Lids of aerosol-tight rotors must be replaced after 50 autoclave cycles to ensure aerosol tightness.

The date of manufacture is stamped on the rotors in the format *03/07* (= March 2007) or on the inside of the plastic rotor lids in the form of a clock ⌚. This is for information only and does not have any reference to the service life.

3.4 Information on product liability

In the following cases, the protection provided by the device may be impaired. The liability for the function of the device passes to the operator if:

- The device is not used in accordance with the operating manual.
- The device is used outside of the range of application described in the preceding chapters.
- The device is used with accessories or consumables (e.g., tubes) which are not recommended by Eppendorf.
- The device is maintained or repaired by persons not authorized by Eppendorf.
- The owner has made unauthorized modifications to the device.

3.5 Warnings for intended use

Read the operating manual first and observe the following general safety instructions before using the Centrifuge 5424 / 5424 R.

3.5.1 Personal injury or damage to the equipment



WARNING!

Risk of electrical shock from damage to the device or mains cable.

- ▶ The device may only be switched on if the device and mains cable are undamaged.
- ▶ Only use devices which have been professionally installed or repaired.



WARNING!

Lethal voltages inside the device.

- ▶ Ensure that the housing is always closed and undamaged so that no parts inside the device can be contacted by accident.
- ▶ Do not remove the housing of the device.
- ▶ Do not allow any liquids to enter the inside of the housing.
- ▶ Do not allow the device to be opened by anyone except service personnel who have been specifically authorized by Eppendorf.



WARNING!

Danger from using an incorrect power supply.

- ▶ Only connect the device to voltage supplies which correspond with the electrical requirements on the name plate.

3 Safety



WARNING!

Damage to health when handling infectious liquids and pathogenic germs.

- ▶ Observe the national regulations for handling these substances, the biological security level of your laboratory, the material safety data sheets and the manufacturer's application notes.
- ▶ Use suitable aerosol-tight closure systems for the centrifugation of these substances.
- ▶ When working with pathogenic germs belonging to a higher risk group, more than one aerosol-tight bioseal must be provided for.
- ▶ Wear personal protective equipment (PPE).
- ▶ Follow the instructions regarding hygiene, cleaning and decontamination.
- ▶ For complete instructions regarding the handling of germs or biological material of risk group II or higher, please refer to the "Laboratory Biosafety Manual" (Source: World Health Organization, current edition of the Laboratory Biosafety Manual).



WARNING!

Centrifuge lid can crush. Keep hands clear.

- ▶ When opening or closing the device lid, do not reach between the lid and device or into the latching mechanism of the lid.
- ▶ Always open the centrifuge lid completely to prevent it from falling.



NOTICE!

Damage to device by spilling liquids in the rotor or rotor chamber

1. Switch the device off.
2. Disconnect the device from the power supply.
3. Clean the device and the accessories carefully in accordance with the cleaning and disinfection instructions in the operating manual.
4. If a different cleaning and disinfecting method is to be used, contact Eppendorf to ensure that the intended method will not damage the device.



NOTICE!

Damage to electronic components through formation of condensation.

After the device has been moved from a cool to a warmer environment, condensation can form inside the device.

- ▶ Wait at least three hours (5424) or four hours (5424 R) before connecting the device to the power supply.
- ▶ **Only 5424:** Alternatively: let the device run for half an hour before transporting it.

3.5.2 Incorrect handling of the centrifuge



NOTICE!

Damage from knocking against or moving the device during operation.

A rotor banging against the rotor chamber wall can cause considerable damage to the device and rotor.

- ▶ Do not move or knock against the device during operation.

3.5.3 Incorrect handling of the rotors



CAUTION!

Risk of injury from improperly attached rotors and rotor lids.

- ▶ Centrifuge only with the rotor and rotor lid firmly tightened.
- ▶ If unusual noises occur when the centrifuge starts, the rotor or the rotor lid may not be properly secured. Stop centrifugation immediately by pressing the **start/stop** key.

3 Safety



CAUTION!

Risk of injury from asymmetric loading of rotors.

- ▶ Load rotors symmetrically with identical tubes.
- ▶ Only load adapters with suitable tubes.
- ▶ Always use tubes of the same type (weight, material/density and volume).
- ▶ Check symmetric loading by balancing the adapters and tubes used with scales.



CAUTION!

Risk of injury from overloaded rotor.

The Centrifuge 5424 / 5424 R is designed for the centrifugation of material with a max. density of 1.2 g/mL at maximum speed and volume and/or load.

- ▶ Observe the information on each rotor relating to maximum load (adapter, tube and contents) per rotor bore and make sure it is not exceeded.



NOTICE!

Damage to rotors from aggressive chemicals.

Rotors are high-quality components which withstand extreme stresses. This stability can be impaired by aggressive chemicals.

- ▶ Avoid the use of aggressive chemicals, including strong and weak alkali, strong acids, solutions with mercury, copper and other heavy metal ions, halogenated hydrocarbons, concentrated saline solutions and phenol.
- ▶ If the rotor is contaminated by aggressive chemicals, clean it immediately using a neutral cleaning agent. This applies to the rotor bores in particular.

3.5.4 Extreme strain on the centrifuging tubes



CAUTION!

Risk of injury from overloaded tubes.

- ▶ Note the loading limits specified by the tube manufacturer.
- ▶ Only use tubes which are approved by the manufacturer for the required rcf.



NOTICE!

Risk from damaged tubes.

Damaged tubes must not be used, as this could cause further damage to the device and the accessories and loss of the samples.

- ▶ Before use, carry out a visual check of all tubes for any damage.



NOTICE!

Risk from open tube lids.

Open tube lids can break off during centrifugation and cause damage to the rotor as well as to the centrifuge.

- ▶ Carefully close all tube lids before centrifuging.

Exception: Note the information on the centrifugation of spin columns in the rotor F-45-18-11-Kit (see *Load the rotor on p. 21*).



NOTICE!

Hazard to plastic tubes from organic solvents.

When using organic solvents (e.g. phenol, chloroform) the density of plastic tubes is reduced, i.e., the tubes could get damaged.

- ▶ Follow the manufacturer's information about the chemical resistance of tubes.

3 Safety



NOTICE!

Sample tubes heat up.

In uncooled centrifuges the temperature in the rotor chamber, rotor and sample can rise to above 40°C dependent on the run time, g-force (rcf) or speed (rpm) and ambient temperature.

- ▶ Note that this can reduce the centrifugation resistance of the sample tubes.
- ▶ Please note the temperature resistance of the samples.

3.5.5 Aerosol-tight centrifugation



WARNING!

Risk to health due to limited aerosol tightness with incorrect rotor/rotor lid combination.

Aerosol-tight centrifugation is guaranteed only if the rotors and rotor lids intended for this purpose are used. These are always indicated by the prefix **FA**.

- ▶ Always use rotors and rotor lids marked aerosol-tight together for aerosol-tight centrifugation.
- ▶ Only use aerosol-tight rotor lids in combination with rotors which are marked on the rotor lid.



WARNING!

Risk to health due to limited aerosol tightness in the event of incorrect use.

Autoclaving, mechanical stresses and contamination by chemicals or other aggressive solvents can impair the aerosol-tightness of the rotors and rotor lid.

- ▶ Regularly check that the seals of aerosol-tight rotor lids are undamaged.
- ▶ Only use aerosol-tight rotor lids with undamaged and clean gaskets.
- ▶ Thinly brush the threads of the rotor lid screw with pivot grease (order no. Int.: 5810 350.050 / North America: 022634330) after every proper autoclaving (121°C, 20 min.). Do not apply the pivot grease to the gaskets.
- ▶ Replace aerosol-tight rotor lids after 50 autoclave cycles.
- ▶ Aerosol-tight rotors should **never** be stored with rotor lids screwed on.

3.6 Safety instructions on the device

Depiction	Meaning	Location
	<p>WARNING</p> <p>General hazard point. Follow the operating manual.</p>	Right side of the device
	<p>CAUTION</p> <p>Always tighten up the rotor using the rotor key supplied.</p>	Top of device, below the centrifuge lid.
	<p>CAUTION</p> <p>Close all tubes and use a rotor lid.</p>	Top of device, below the centrifuge lid.

4 Installation

4.1 Selecting the location



NOTICE!

If a fault occurs, objects in the immediate vicinity of the devices could get damaged.

- ▶ In accordance with the recommendations of EN 61010-2-020, leave a safety distance of **30 cm** clear around the device during operation.



NOTICE!

Damage from overheating.

- ▶ Do not place the device close to sources of heat (e.g., radiator, drying cabinet).
- ▶ Do not expose the device to direct sunlight.
- ▶ Ensure free circulation of air by maintaining a distance of at least 30 cm on all sides of the device from adjacent devices or the wall and keep the underside of the device clear.
- ▶ Make sure that the vents in the device are always free of obstruction.

Select the location for the device according to the following criteria:

- Suitable power connection as per the name plate (230 V/120 V/100 V).
- Stable, horizontal and resonance-free lab bench. Weight of the device: 13.4 kg (5424) or 21 kg (5424 R).
- A well ventilated environment which is protected from direct sunlight to prevent the device from heating up more.

4.2 Installing the instrument



NOTICE!

Centrifuge 5424 R: Compressor damage after improper transport.

- ▶ Only switch on the centrifuge 4 hours after installation.

Perform the following steps in the sequence described.

1. Place the device on a suitable lab bench.
2. Allow the device to warm up for at least 3 hours (5424) or 4 hours (5424 R) to the ambient temperature to prevent damage to the electronic components from condensation and damage to the compressor (only 5424 R).
3. Check that the mains voltage and frequency match the requirements on the device type plate.
4. Connect the centrifuge to the mains and switch it on using the mains power switch on the right side of the device.
 - The display is active.
 - **Only 5424:** Lid opens automatically
5. Use the details included in the scope of delivery to check that the delivery is complete.
6. Check all parts for any transport damage. Contact your dealer if any damage is found.
7. **Only 5424 R:** Insert the condensation water tray at the left side of the device into the holder provided (see Fig. 2 on p. 8).



Retain the packaging material and the transport protection device for subsequent transport or storage. See also the instructions relating to transport (see p. 33).

5 Operation

5.1 Overview of operating controls

The Centrifuge 5424 / 5424 R is available in two versions: keypad or rotary knobs. This operating manual generally describes how to operate the keypad version. However, it also applies to the rotary knob version.

Before using the Centrifuge 5424 / 5424 R for the first time, familiarize yourself with the operating controls and the display.

The depiction of the operating controls and the display can also be found on the front fold-out page (see Fig. 3 and Fig. 4).

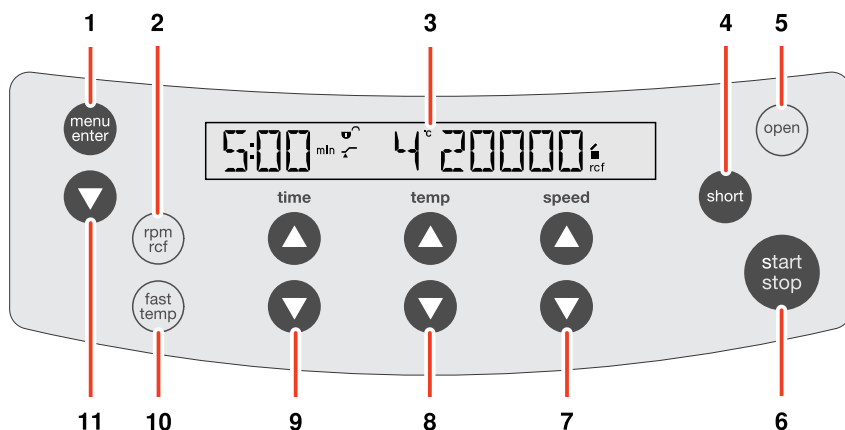

Fig. 3: Control panel of the Centrifuge 5424 / 5424 R

1 Call and select the menu parameters (see <i>Device menu</i> on p. 20)	2 Switch the displayed centrifuging speed (rpm/rcf) (see <i>Rcf display and calculation</i> on p. 11)
3 Display	4 Short spin centrifugation (see <i>Short spin centrifugation</i> on p. 26)
5 Release lid	6 Start and stop centrifugation
7 Set the speed of centrifugation Dependent on device version designed as a key or dial.	8 Adjust the temperature (only 5424 R)
9 Adjust the centrifuging duration Dependent on device version designed as a key or dial.	10 Start the temperature control run fast temp (only 5424 R)
11 Select the menu item (see <i>Menu navigation</i> on p. 21)	

Please also read the precise description of the individual menu functions (see p. 20).

5 Operation

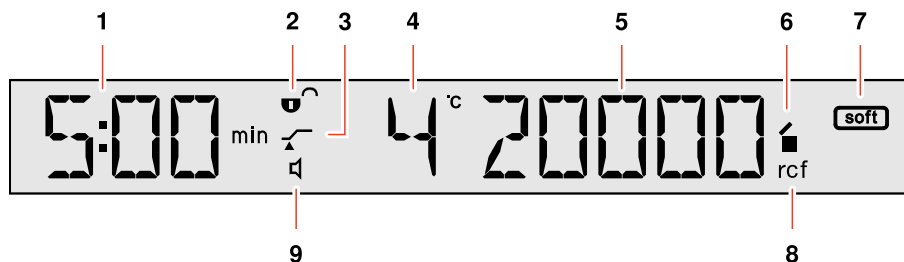

















Fig. 4: Display of the Centrifuge 5424 / 5424 R

<p>1 Centrifuging duration</p>	<p>2 Status of the key lock (LOCK) : Centrifuging parameters cannot be modified unintentionally. : No key lock.</p>
<p>3 Status of the function ATSET : Start of operation when reaching 95% of the preset g-force (rcf) or speed (rpm). : Start of operation immediately.</p>	<p>4 Temperature (only 5424 R)</p>
<p>5 g-force (rcf) or speed (rpm) <i>(see Rcf display and calculation on p. 11)</i></p>	<p>6 Status of the centrifuge : Centrifuge lid unlocked. : Centrifuge lid locked.  (Flashing): centrifuging in progress.</p>
<p>7 Soft ramp : Rotor accelerates and brakes slowly. No symbol: Rotor accelerates and brakes rapidly.</p>	<p>8 Status of the centrifugation speed display rcf: g-force (relative centrifugal force) rpm: revolutions per minute</p>
<p>9 Status of the loudspeaker : Switched on : Switched off</p>	

5 Operation

5.2 Device menu







Tab. 1: Menu structure of the Centrifuge 5424 / 5424 R. All menu levels contain the additional menu item **Back**.

Level 1 (M 1)	Level 2 (M 2)	Function	Display
SOFT Soft ramp: Reduce speed of acceleration and braking ramp. Not used for short spin centrifugation.	On	Rotor accelerates and brakes slowly.	(SOFT)
	Off	Rotor accelerates and brakes rapidly.	
LOCK Key lock: Set the current centrifugation parameters permanently to prevent the time, temperature (only 5424 R) g-force (rcf) or speed (rpm) from being unintentionally modified.	On	Set the centrifugation parameters permanently. When you select the keys time , temp (only 5424 R) and speed , the display shows SAFE .	
	Off		
ATSET Set start of centrifuging run time.	On	The set time is counted down only once 95% of the specified g-force (rcf) or speed (rpm) has been reached.	
	Off	The set time is counted down immediately.	
SHORT Before the start of a short run (see <i>Short spin centrifugation on p. 26</i>) it is possible to switch between the maximum and currently set g-force (rcf) or speed (rpm). The SOFT function is not used for short spin centrifugation.	MAX	Short spin run at maximum g-force (rcf) or speed (rpm) of the rotor used.	
	Set	Short run at set g-force (rcf) or speed (rpm).	
TEMP (only 5424 R) Set the time limitation of continuous cooling (see p. 24).	8 h	Preset value.	
	oo	Endless operation of continuous cooling. Icing possible! Note that this may reduce the service life of the compressor.	
ALARM	On	Switch on loudspeaker.	
	Off	Switch off loudspeaker.	
VOL	VOL1 ... VOL5	Adjust the speaker volume in 5 steps. The loudspeaker must be switched on for the adjustment to be audible.	
SLEEP Standby mode	On	If the centrifuge has not been used for 15 min and the standby mode has been switched on, it switches to standby mode. The EP logo then appears in the display. When a button or knob is used or the centrifuge lid is closed, the centrifuge is reactivated. It is then ready for operation.	
	Off	Standby mode deactivated.	
LID (only 5424) Lid release, from software version 2.2.	AUTO	The centrifuge lid opens automatically after centrifugation.	
	Off	The centrifuge lid must be manually opened with the open key after centrifugation.	

5 Operation

5.3 Menu navigation

To change settings in the device menu, proceed as follows:

1.  Open the menu.
2.  Select the desired menu item.
3.  Confirm your selection.
4.  Select the setting of the parameters in question.
5.  Confirm the changed setting.
The **BACK** menu item belonging to the first menu level appears.
6.  Exit the menu.



To exit the second menu level without changing a parameter, select the **BACK** menu item and confirm with **menu/enter**.

5.4 Preparing for centrifugation

5.4.1 Switch on centrifuge

1. Switch the centrifuge on, using the mains switch.
Only 5424: After switching on at the mains power switch, the centrifuge lid opens automatically.
2. Open the closed centrifuge lid by pressing the **open** key.
The parameter settings of the last run are displayed.

5.4.2 Inserting the rotor

1. Place rotor vertically onto the motor shaft.
2. Insert the rotor key supplied into the rotor nut.
3. Turn rotor key **clockwise** until the rotor nut is firmly tightened.

5.4.3 Load the rotor



CAUTION!

Risk of injury from asymmetric loading of rotors.

- ▶ Load rotors symmetrically with identical tubes.
- ▶ Only load adapters with suitable tubes.
- ▶ Always use tubes of the same type (weight, material/density and volume).
- ▶ Check symmetric loading by balancing the adapters and tubes used with scales.

5 Operation



CAUTION!

Risk from damaged or overloaded tubes!

- ▶ When loading the rotor, note the safety instructions with regard to hazards from overloaded or damaged tubes (see *Warnings for intended use on p. 13*)



Rotor lid!

- Fixed-angle rotors may only be operated with the appropriate rotor lid in each case. This is clearly shown by the identical rotor name labeling on the rotor and on the rotor lid.
- To carry out an aerosol-tight centrifugation, an aerosol-tight rotor (marking: **red ring**) and the corresponding aerosol-tight rotor lid (marking: **aerosol-tight** and **red lid screw**) must be used.

To load the rotor, proceed as follows:

1. Check the maximum load (adapter, tube and content) per rotor bore.
The information about this can be found on every rotor and in this operating manual (see *Rotors on p. 10*).
2. Load rotors and adapters only with the tubes intended for them.
3. Insert tubes opposite each other in pairs into the rotor bores. For symmetrical loading, tubes that are opposite each other must be of the same type and contain the same filling quantity.

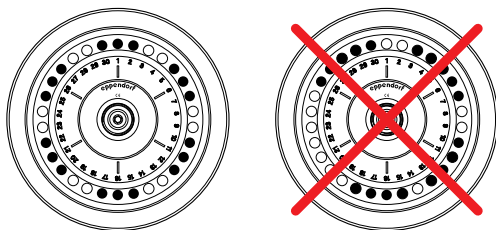

In order to minimize weight differences between filled sample tubes, we recommend taring with a scale. This will reduce wear on the drive and cut running noise.

4. Attach and tighten rotor lid.



With the rotors FA-45-24-11 and FA-45-24-11-Special centrifugation is also possible without a rotor lid.

Please also note:

- The tube lids must be closed securely.
- The rotors are not aerosol-tight without rotor lid.
- The centrifugation is slightly louder.
- Spin columns must always be centrifuged with a rotor lid.



Spin columns

For centrifuging spin columns in the rotor F-45-18-11-Kit, you can leave the tube lids open. However, this is possible only using the tubes provided for this purpose by kit manufacturers. For reliable centrifugation, you must lean the open tube lids against the edge of the rotor. Ensure that this does not involve the lids projecting beyond the edge of the rotor, and then put on the associated rotor lid.

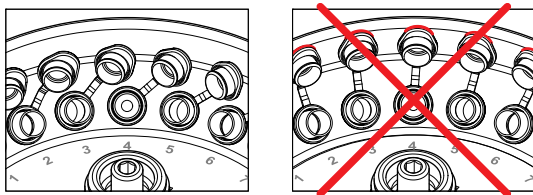

5 Operation

5.4.4 Close centrifuge lid



WARNING!

Centrifuge lid can crush. Keep hands clear.

- ▶ When opening or closing the device lid, do not reach between the lid and device or into the latching mechanism of the lid.
- ▶ Always open the centrifuge lid completely to prevent it from falling.

1. Check correct attachment of rotor and rotor lid.
 2. Push down the centrifuge lid until the lid latch engages and the lid is automatically closed. The centrifuge will close automatically.
- The **open** key lights blue. The display shows the symbol .

5.5 Cooling (only 5424 R)

5.5.1 Temperature adjustment

- ▶ Set the temperature using the **temp** arrow keys from -10°C to $+40^{\circ}\text{C}$. You can also modify the temperature during centrifugation.

5.5.2 Temperature display

If the rotor is stopped:	Set temperature
During centrifugation:	Actual temperature

5.5.3 Temperature monitoring

After the set temperature has been reached the centrifuge responds as follows to temperature fluctuations during centrifugation:

Deviation from the target value	Action
$\Delta T > 3^{\circ}\text{C}$	Temperature display flashes.
$\Delta T > 5^{\circ}\text{C}$	Display Error 18 . Centrifugation is stopped automatically.

5.5.4 Fast Temp

This function can be used to start a temperature control run directly without samples with a rotor and temperature-specific speed in order to quickly adjust the rotor chamber up to the set target temperature.

Requirement

- The centrifuge is switched on.
- The rotor and rotor lid are properly attached.
- The centrifuge lid is closed.
- The temperature and g-force (rcf) or speed (rpm) are set for the subsequent centrifugation (see *Centrifuging on p. 24*).

1. Press the **fast temp** key.
 - The display shows **FT** as well as the current temperature and g-force (rcf) or speed (rpm).
 - The cooling time from room temperature ($\sim 21^{\circ}\text{C}$) to 4°C takes approx. 8 min.
 - The temperature control cycle ends automatically when the target temperature has been reached. A periodic signal tone sounds.

5 Operation

2. Press the **start/stop** key to terminate the temperature control run early.

After the temperature control run is complete the centrifuge keeps the rotor chamber, with the centrifuge lid closed, at the set temperature, if the temperature is below the ambient temperature. Irrespective of the target temperature, however, this continuous cooling does not go below 4 °C to prevent the rotor chamber from freezing.

5.5.5 Continuous cooling

When the rotor is stopped the rotor chamber is kept at the target temperature when the following prerequisites are met:

- The centrifuge is switched on.
- The centrifuge lid is closed.
- The target temperature is below the ambient temperature.

During continuous cooling the following applies:

- The target temperature is displayed.
- Irrespective of the target temperature, continuous cooling does not go below 4 °C to prevent the rotor chamber and the samples from freezing and increased condensation in the device.
- Because the rotor does not rotate during this process the temperature adjustment is slower.

To end continuous cooling, open the centrifuge lid.

If the centrifuge is not used for more than 8 hours, the continuous cooling is switched off automatically. This protects against ice formation in the rotor chamber and in the tubes as well as increased condensation in the device.

The device then switches to standby mode. The **EP** logo appears in the display.

With **fast temp** you can quickly reach the desired temperature again (see p. 23).

You can change continuous cooling to endless operation. To do so, in the device menu under **TEMP** enable the 'oo' (see p. 20) option. Note that this may reduce the service life of the compressor.

5.6 Centrifuging



CAUTION!

Risk from incorrectly-loaded rotors and damaged/overloaded tubes!

- ▶ Before commencing centrifugation, follow the safety instructions relating to hazards from asymmetrically loaded and/or overloaded rotors and from overloaded, damaged and/or open tubes (see *Warnings for intended use on p. 13*).



CAUTION!

Risk of injury from improperly attached rotors and rotor lids.

- ▶ Centrifuge only with the rotor and rotor lid firmly tightened.
- ▶ If unusual noises occur when the centrifuge starts, the rotor or the rotor lid may not be properly secured. Stop centrifugation immediately by pressing the **start/stop** key.

Before using the Centrifuge 5424 / 5424 R for the first time, familiarize yourself with the operating controls and the display (see *Overview of operating controls on p. 18*).

Each of the centrifuging variants described here must be preceded by the preparation described above (see *Preparing for centrifugation on p. 21*).

Only 5424 R: Please also note the instructions on cooling (see p. 23).

5 Operation

5.6.1 Centrifuging with time preset

Perform the following steps in the sequence described.

1. Use **time** to set the run time.
2. **Only 5424 R:** Use **temp** to set the temperature.
3. Use **speed** to set the g-force (rcf) or speed (rpm).
4. Press **start/stop** to start centrifuging.

During centrifugation

- In the display ■ flashes while the rotor is running.
- The remaining run time is displayed in minutes, in 30s increments below ten minutes. The last minute is counted down in seconds.
- **Only 5424 R:** The actual temperature is displayed.
- The **fast temp** (only 5424 R), **open**, **short** as well as the device menu are blocked during centrifugation.
- During the run you can modify the total run time, the temperature (only 5424 R), the speed and the rpm/rcf display.

The values flash in the display during the change. The new parameters are adopted immediately. When the time is changed during a run, the time which has already elapsed is taken into account. Note that the shortest new total run time which can be set is the time which has already elapsed plus 2 minutes.

- You can also terminate the centrifugation before the set run time has elapsed by pressing the **start/stop** key.

End of centrifugation

- After completion of the set time, the centrifuge stops automatically. During braking the elapsed centrifugation time is displayed flashing. When the rotor stops a signal tone is sounded.
- **Only 5424:** The centrifuge lid opens automatically. The display shows the symbol ☒.
- **Only 5424 R:** The centrifuge lid remains closed to maintain the sample temperature. You can open it by pressing the **open** key.

5. Remove centrifuge contents.

5.6.2 Centrifuging in continuous operation

Perform the following steps in the sequence described.

1. Use **time** to set the continuous run.

The continuous run function can be set above 9:59 h or below 30 s. The timer shows **oo** to indicate continuous operation.

2. **Only 5424 R:** Use the **temp** arrow keys to adjust the temperature.
3. Use **speed** to set the g-force (rcf) or speed (rpm).
4. Press **start/stop** to start centrifuging.

In the display ■ flashes while the rotor is running.

Time is counted upwards, first in 30-second increments and then in minute increments from ten minutes.

5. Press **start/stop** to end centrifuging after the desired time period.
 - During the braking process, centrifuging duration flashes in the display.
 - When the rotor stops a signal tone is sounded.
 - **Only 5424:** The centrifuge lid opens automatically. The display shows the symbol ☒.
 - **Only 5424 R:** The centrifuge lid remains closed to maintain the sample temperature. You can open it by pressing the **open** key.
6. Remove centrifuge contents.

5 Operation

5.6.3 Short spin centrifugation

You can carry out a short spin run with the currently set or with the maximum g-force (rcf) or speed (rpm) of the rotor used. This is set in the device menu (see *Device menu on p. 20*) before executing the following steps in the sequence specified:

Performing short spin centrifugation

1. A short run at current g-force (rcf) or speed (rpm) can be set directly using the **speed** arrow keys.
2. **Only 5424 R:** Use the **temp** arrow keys to adjust the temperature.
3. Start short spin run: Hold down the **short** key.
 - In the display ■ flashes while the rotor is running.
 - The time is counted upwards in seconds.
 - During short run centrifuging all other keys are blocked.
4. End short spin run: Release the **short** key.
 - During the braking process, centrifuging duration flashes in the display.
 - **Only 5424:** The centrifuge lid opens automatically. The display shows the symbol ☒.
 - **Only 5424 R:** The centrifuge lid remains closed to maintain the sample temperature. You can open it by pressing the **open** key.
5. Remove centrifuge contents.



During the braking process, centrifuging can be restarted up to two more times by pressing the **short** key again.



Soft ramp is not used for short spin centrifugation.

5.6.4 Removing the rotor

1. Turn the rotor nut **counterclockwise** using the rotor key supplied.
2. Remove rotor by lifting vertically.
3. **Only 5424 R:** Switch off the centrifuge after use and empty the condensation water tray (pull out from the left side of the device). Leave centrifuge lid fully opened and protect it against closing.

6 Maintenance

6.1 Prepare cleaning / disinfection

Clean at least once a week and clean if the accessible surfaces of the device and its accessories are acutely contaminated.

Clean the rotor regularly. This way the rotor is protected and the durability is prolonged.

Furthermore, observe the notes on decontamination (see *Decontamination before shipping on p. 29*) when the device is sent to the authorized Technical Service for repairs.

The procedure described in the following chapter applies for the cleaning as well as for the disinfection or decontamination. The additional required steps are described in the following table:

Cleaning	Disinfecting / decontamination
<ol style="list-style-type: none"> 1. For cleaning the accessible surfaces of the device and the accessories use a mild cleaning fluid. 2. Carry out the cleaning as described in the following chapter. 	<ol style="list-style-type: none"> 1. Choose the disinfection method which corresponds to the legal regulations and guidelines in place for your range of application. For example, use alcohol (ethanol, isopropanol) or alcohol-based disinfectants. 2. Carry out the disinfection or decontamination as described in the following chapter. 3. Then clean the device and the accessories.



If you have any further questions regarding the cleaning and disinfection or decontamination or regarding the cleaning fluid to be used, contact the Eppendorf AG Application Support. The contact details are provided on the back of this manual.

6.2 Perform cleaning / disinfection



DANGER!

Electric shock as a result of penetration of liquid.

- ▶ Switch off the device and disconnect it from the power supply before any maintenance or cleaning work is carried out.
- ▶ Do not allow any liquids to enter the inside of the housing.
- ▶ Do you use any spray disinfectants on the housing.
- ▶ Only reconnect the device to the power supply once it is completely dry.



NOTICE!

Damage from using aggressive chemicals.

- ▶ Do not use any aggressive chemicals on the device or its accessories, such as strong and weak bases, strong acids, acetone, formaldehyde, halogenated hydrocarbons or phenol.
- ▶ If the device becomes contaminated with aggressive chemicals, clean it immediately with a mild cleaning agent.



NOTICE!

Corrosion from aggressive cleaning agents and disinfectants.

- ▶ Do not use corrosive cleaning agents, aggressive solvents or abrasive polishes.
- ▶ Do not incubate the accessories in aggressive cleaning agents or disinfectants for prolonged periods.

6 Maintenance



NOTICE!

Damage from UV and other high-energy radiation.

- ▶ Do not disinfect by any method based on UV, beta and gamma radiation or other high-energy radiation.



Autoclave

All Rotors, rotor lid and adapter can be autoclaved (121 °C, 20 min).
After a maximum of 50 autoclave cycles, replace the lids of the aerosol-tight rotors.



Aerosol-tightness

Check that the seals are intact before use.

Replace the rotor lids of aerosol-tight rotors when the sealing rings on the lid screw and in the lid groove are worn. The sealing rings require regular care to protect the rotors.

Aerosol-tight rotors should never be stored with lids screwed on!

In order to prevent damage, lightly lubricate the lid thread of the aerosol-tight rotors with pivot grease (order no. Int.: 5810 350.050 / North America: 022634330) on a regular basis.

6.2.1 Clean / disinfect device

1. Switch off the device from the mains power switch while the lid is opened and remove the mains power switch from the power supply.
2. Unscrew the rotor nut by turning it counterclockwise with the rotor key.
3. Remove rotor.
4. Use the agents specified above (see p. 27) to clean and disinfect the device and the rotor chamber.
5. Wipe all accessible surfaces of the device and the accessories, including the power cable, with a moist cloth.
6. Thoroughly clean the rubber seals of the rotor chamber with water.
7. Rub the dry rubber seals with glycerine or talcum powder to prevent them from becoming brittle. Other components of the device, such as the lid latch, motor shaft and rotor cone, must not be lubricated.
8. Clean the motor shaft with a soft, dry and lint-free cloth.
9. Check device and accessories for corrosion and damage.

6.2.2 Clean / disinfect rotor

1. Clean Rotors, rotor lid and adapter with the aforementioned agents and disinfect them (see p. 27).
2. Use a bottle brush to clean and disinfect the rotor bores.
3. Rinse Rotors, rotor lid and adapter thoroughly with water. Pay particular attention to the rotor bores of the fixed-angle rotors.
4. Place rotors and accessories onto a cloth to dry. Place fixed angle rotors with the rotor bores facing downwards to allow the bores to dry as well.
5. Clean the rotor cone with a soft, dry and lint-free cloth and inspect for damage. Do not lubricate the rotor cone.
6. Place the dry rotor onto the motor shaft.
7. Tighten the rotor nut firmly by turning it clockwise with the rotor key.

6 Maintenance

6.3 Additional service instructions for Centrifuge 5424 R

- ▶ Empty and clean the condensation water tray regularly and especially after liquid spillage in the rotor chamber. Pull out the tray for condensation water from the left side of the centrifuge.
- ▶ Clear the rotor chamber regularly of ice formations by thawing, either by leaving the centrifuge lid open or carrying out a brief temperature control run at approx. 30 °C.
- ▶ Wipe up condensate in the rotor chamber. To do so, use a soft absorbent cloth.
- ▶ Remove dust deposits from the ventilation slits of the centrifuge using a brush or swab at the latest every six months. First switch off the device and remove the power plug.

6.4 Glass breakage



Note when using glass tubes that the danger of breakage of glass increases with an increasing g-force (rcf) or speed (rpm). Please note the manufacturer's information on the recommended centrifugation parameters (loading and speed).

Broken glass scratches the surfaces of the rotor chamber and the accessories (Rotors, rotor lid and adapter) so that their chemical resistance is reduced. Therefore, a fine, black metal abrasion develops in the rotor chamber due to the air turbulence which, in addition to causing damage to the rotor chamber and the accessories, can also contaminate the samples.

- ▶ Carefully remove all splinters and glass powder from the rotor chamber and accessories when breakage of glass occurs (Rotors, rotor lid and adapter).
- ▶ If required, replace the adapters to prevent any further damage.
- ▶ Check rotor bores regularly for residues or damage.

6.5 Fuses

The fuse holder is located under the mains power socket (5424) (Fig. 1 on p. 8) or on the right next to the mains switch (5424 R) (Fig. 2 on p. 8).

1. Disconnect the mains plug.
 2. Remove the fuse holder.
- Both fuses are now accessible and can be replaced.

6.6 Decontamination before shipping

If you are shipping the device to the authorized Technical Service for repairs or to your authorized dealer for disposal please note the following:



WARNING!

Risk to health from contaminated device.

1. Follow the instructions in the decontamination certificate. This can be found in a PDF file on our homepage (www.eppendorf.com/decontamination).
2. Decontaminate all the parts you want to dispatch.
3. Enclose the fully-completed decontamination certificate for returned goods (incl. the serial number of the device) with the dispatch.

7 Troubleshooting

If the suggested measures fail repeatedly, please contact Technical Service. You can find the contact addresses at the end of this operating manual or on the Internet under www.eppendorf.com.

7.1 General errors

Symptom / message	Cause	Remedy
No display.	No mains connection.	▶ Check the mains power connection.
No display.	Power failure.	▶ Check the mains fuse for the device (see <i>Fuses on p. 29</i>). ▶ Check the mains fuse for the laboratory.
Lid of the device cannot be opened.	Rotor is still running.	▶ Wait for the rotor to stop.
Lid of the device cannot be opened.	Power failure.	1. Check the mains fuse for the device (see <i>Fuses on p. 29</i>). 2. Check the mains fuse for the laboratory. 3. Activate the emergency lid release (see p. 32) .
Device cannot be started.	Lid of the device is not closed.	▶ Close the lid of the device.
Device shakes when it starts up.	Rotor is unsymmetrically loaded.	1. Stop the device and load symmetrically. 2. Restart the device.
Centrifuge brakes during a short run centrifugation, although the short key is pressed.	The short key was released briefly more than twice (protective function for the drive).	▶ Press the short key continuously during a short run centrifugation.
Temperature display flashes. (only 5424 R)	Temperature variation from nominal value: $\Delta T > 3^{\circ}\text{C}$.	▶ Check the settings. ▶ Check unhindered air circulation through the vents. ▶ Thaw ice or switch off device and allow it to cool down.

7 Troubleshooting

7.2 Error messages

If one of the following error messages appears, proceed as follows:

1. Remove fault (see Remedies).
2. If necessary, repeat centrifugation.

Symptom / message	Cause	Remedy
LID ERROR	Centrifuge lid cannot be locked.	▶ Try to close the centrifuge lid again.
LID ERROR	Centrifuge lid cannot be released.	1. Switch the device off and back on. 2. Press the open key. If the error occurs again: 1. Switch off the centrifuge. 2. Activate the emergency lid release (see <i>Emergency release on p. 32</i>).
LID ERROR	Centrifuge lid must not be released during a run.	▶ Wait for the rotor to stop.
LID LIFT (only 5424 R)	Centrifuge lid has not been opened wide enough.	▶ Open the centrifuge lid wider by hand.
INT	Mains power failure during a run.	▶ Check the mains connection.
NO RPM	Error in speed measuring system.	▶ Leave the device switched on until the error message disappears (10 s or 6 min).
Err 6	Drive error.	▶ Repeat the run. ▶ If this error message appears again, switch centrifuge off and back on again after > 20 s.
Err 6	Drive overheated.	▶ Allow the drive to cool down for at least 15 min.
Err 7	Major deviation in the speed control.	1. Wait for the rotor to stop. 2. Tighten the rotor.
Err 8	Drive error.	1. Wait for the rotor to stop. 2. Repeat the run.
Err 9 to 17	Electronics error.	▶ Switch the centrifuge off and back on again after > 20 s.
Err 18 (only 5424 R)	Too high temperature variation from nominal value in the rotor chamber.	▶ Check the settings. ▶ Check unhindered air circulation through the vents. ▶ Thaw ice or switch off device and allow it to cool down.
Err 19 (only 5424 R)	Cooling circuit is overheated.	▶ Check unhindered air circulation through the vents and allow device to cool down.
Err 20 (only 5424 R)	Temperature sensor in rotor chamber faulty.	▶ Switch the centrifuge off and back on again after > 20 s.
Err 21 (only 5424 R)	Temperature sensor at capacitor faulty.	▶ Switch the centrifuge off and back on again after > 20 s.
Err 24 (only 5424 R)	Cooling unit fault, e.g., overheating.	▶ Allow the centrifuge to cool down and repeat the cycle.

7 Troubleshooting

7.3 Emergency release

If the centrifuge lid cannot be opened, you can activate the emergency release manually.



WARNING!

Risk of injury from rotating rotor.

- ▶ Wait for the rotor to stop before activating the emergency lid release.
- ▶ To check, look through the inspection glass in the centrifuge lid.



To operate the emergency release, use the rotor key supplied with the Centrifuge 5424 / 5424 R.

1. Disconnect the mains plug.
2. Remove the plastic cover for the emergency release on the right side of the device (see Fig. 1 and Fig. 2).
 - 5424:** Simply remove the plastic cover.
 - 5424 R:** Turn the plastic cover using an appropriate tool (e.g., screwdriver) by 90° in a counterclockwise direction and remove it.
3. Insert the centrifuge rotor key into the hexagonal opening at rear until some resistance can be felt.
4. **Slightly press** and turn the rotor key counterclockwise.
This will release the centrifuge lid.
5. Open the centrifuge lid.
6. Remove the rotor key and fit or turn the plastic covers back on.
 - Only 5424 R:** Turn the plastic cover using an appropriate tool (e.g., screwdriver) by 90° in a clockwise direction.

8 Transport, storage and disposal

8.1 Transport

- ▶ Only transport the device in the original packaging.
- ▶ Use a transport aid for transporting over longer distances.

	Air temperature	Rel. humidity	Air pressure
General transportation	-25 to 60 °C	10 to 75%	30 to 106 kPa
Air freight	-20 to 55 °C	10 to 75%	30 to 106 kPa

8.2 Storage

	Air temperature	Rel. humidity	Air pressure
In transport packaging	-25 to 55 °C	10 to 75%	70 to 106 kPa
Without transport packaging	-5 to 45 °C	10 to 75%	70 to 106 kPa

8.3 Disposal

In case the product is to be disposed of, the relevant legal regulations must be observed.

Information on the disposal of electrical and electronic devices in the European Community:

The disposal of electrical devices is regulated within the European Community by national regulations based on EU Directive 2002/96/EC pertaining to waste electrical and electronic equipment (WEEE).

According to these regulations, any devices supplied after August 13, 2005 on a business-to-business basis, to which this product is assigned, may no longer be disposed of in municipal or household waste. To document this they have been marked with the following identification:



Because disposal regulations may differ from one country to another within the EU please contact your supplier if necessary.

9 Technical data

9.1 Power supply

Centrifuge 5424

Mains power connection	230 V, 50 to 60 Hz 120 V, 50 to 60 Hz 100 V, 50 to 60 Hz
Current consumption:	1.9 A (230 V) 3.8 A (120 V) 4.0 A (100 V)
Power consumption:	max. 250 W
EMC: Interference emission (radio interference)	EN 61326 - category B
EMC: Noise immunity	EN 61326 - performance characteristic B
Overvoltage category:	II
Fuses:	3.15 AT (230 V) 6.3 AT (120 V / 100 V)

Centrifuge 5424 R

Mains power connection	230 V, 50 to 60 Hz 120 V, 50 to 60 Hz 100 V, 50 to 60 Hz
Current consumption:	1.6 A (230 V) 3.2 A (120 V) 3.4 A (100 V)
Power consumption:	max. 350 W
EMC: Interference emission (radio interference)	EN 61326 - category B
EMC: Noise immunity	EN 61326 - performance characteristic B
Overvoltage category:	II
Fuses:	3.15 AT (230 V) 6.3 AT (120 V / 100 V)

9.2 Ambient conditions

Environment:	For indoor use only.
Ambient temperature:	Centrifuge 5424: 2 to 40°C Centrifuge 5424 R: 10 to 40°C
Max. relative humidity:	10 to 75 %, non-condensing humidity
Atmospheric pressure:	Use up to an altitude of 2000 m above MSL.
Degree of contamination:	2

9 Technical data

9.3 Weight / dimensions

Centrifuge 5424

Dimensions:	Width: 236 mm (9.30 in.) Depth: 320 mm (12.60 in.) Height: 227 mm (8.94 in.)
Weight without rotor:	13.4 kg (29.5 lb)
Noise level:	< 51 dB(A) *

Centrifuge 5424 R

Dimensions:	Width: 290 mm (11.42 in.) Depth: 480 mm (18.90 in.) Height: 260 mm (10.24 in.)
Weight without rotor:	21.0 kg (46.3 lb)
Noise level:	< 54 dB(A) *

*) The noise level was measured according to DIN EN ISO 3745 frontally in a sound measuring room with accuracy class 1 at a distance of 1 m from the device and at lab bench height.

9.4 Application parameters

Acceleration and deceleration times of Centrifuge 5424 / 5424 R with the rotor FA-45-24-11 (according to DIN 58 970)

Rotor	Without soft ramp	With soft ramp SOFT
FA-45-24-11	15 s / 16 s	5424 : 24 s / 28 s 5424 R: 26 s / 28 s

These values were calculated for 230 V at 23 °C.

9.4.1 Centrifuge 5424

Run time:	30 s to 9:59 h, infinitely (∞), adjustable up to 10 min. in 0.5 min. increments, thereafter in 1 min. increments.
Relative centrifugal force (RZB or rcf):	1 to 20,238 x g (230 V, 100 V) 1 to 21,130 x g (120 V) adjustable in 50 x g increments.
Speed:	100 to 14,680 rpm (230 V, 100 V) 100 to 15,000 rpm (120 V) adjustable in 50 rpm increments.
Max. load:	24 micro test tubes of 2.0 mL each.
Max. kinetic energy:	4070 Nm
Test log mandatory:	No
Permitted density of the material for centrifuging (at max. g-force (rcf) or speed (rpm) and max. load):	1.2 g/mL

9 Technical data

9.4.2 Centrifuge 5424 R

Run time:	30 s to 9:59 h, infinitely (∞), adjustable up to 10 min. in 0.5 min. increments, thereafter in 1 min. increments.
Temperature:	-10°C to 40°C
Relative centrifugal force (RZB or rcf):	1 to 21,130 x g, adjustable in 50 x g increments.
Speed:	100 to 15,000 rpm, adjustable in 100 rpm increments.
Max. load:	24 micro test tubes of 2.0 mL each.
Max. kinetic energy:	4070 Nm
Test log mandatory:	No
Permitted density of the material for centrifuging (at max. g-force (rcf) or speed (rpm) and max. load):	1.2 g/mL

10 Ordering information

10.1 Centrifuge 5424

Order No. (International)	Order No. (North America)	Description
5424 000.215 -	022620452 022620498	Centrifuge 5424 with keypad, without rotor 230 V / 50 - 60 Hz 120 V / 50 - 60 Hz, with US-plug
5424 000.010 -	022620461 022620444	Centrifuge 5424 with keypad, incl. rotor FA-45-24-11 230 V / 50 - 60 Hz 120 V / 50 - 60 Hz, with US-plug
5424 000.614 -	022620436 022620487	Centrifuge 5424 with knobs, without rotor 230 V / 50 - 60 Hz 120 V / 50 - 60 Hz, with US-plug
5424 000.410 -	022620428 022620401	Centrifuge 5424 with knobs, incl. rotor FA-45-24-11 230 V / 50 - 60 Hz 120 V / 50 - 60 Hz, with US-plug

10.2 Centrifuge 5424 R

Order No. (International)	Order No. (North America)	Description
5404 000.219 -	5404000219 5404000332	Centrifuge 5424 R with keypad, without rotor 230 V / 50 - 60 Hz 120 V / 50 - 60 Hz, with US-plug
5404 000.014 -	5404000014 5404000138	Centrifuge 5424 R with keypad, incl. rotor FA-45-24-11 230 V / 50 - 60 Hz 120 V / 50 - 60 Hz, with US-plug
5404 000.618 -	5404000618 5404000731	Centrifuge 5424 R with knobs, without rotor 230 V / 50 - 60 Hz 120 V / 50 - 60 Hz, with US-plug
5404 000.413 -	5404000413 5404000537	Centrifuge 5424 R with knobs, incl. rotor FA-45-24-11 230 V / 50 - 60 Hz 120 V / 50 - 60 Hz, with US-plug

10 Ordering information

10.3 Accessories

10.3.1 Rotors and rotor lids

Order No. (International)	Order No. (North America)	Description
5424 702.007	022653008	Rotor FA-45-24-11 aerosol-tight*, aluminum, 45° angle, 24 places, max. tube diameter 11 mm, incl. rotor lid (aluminum)
5424 703.003	022653024	Replacement lid for rotor FA-45-24-11 aerosol-tight*, aluminum
5424 700.004	022653041	Rotor FA-45-24-11-Special aerosol-tight*, aluminum, PTFE-coated, 45° angle, 24 places, max. tube diameter 11 mm, incl. rotor lid (aluminum)
5424 701.000	022653067	Replacement lid for rotor FA-45-24-11-Special aerosol-tight*, aluminum, PTFE-coated
5424 706.002	022653083	Rotor F-45-18-11-Kit aluminum, 45° angle, 18 places, max. tube diameter 11 mm, incl. rotor lid (polypropylene)
5424 707.009	022653105	Spare lid for rotor F-45-18-11-Kit polypropylene
5424 704.000	022653121	Rotor F-45-32-5-PCR incl. rotor lid (aluminum)
5424 708.005	022653148	Spare lid for rotor FA-45-32-5-PCR aluminium

*) Aerosol impermeability tested and certified by the Centre of Emergency Preparedness and Response, Health Protection Agency, Porton Down (UK).

10.3.2 Adapters

Order No. (International)	Order No. (North America)	Description
5425 715.005 5425 717.008 5425 716.001	022636260 022636243 022636227	Adapter used in FA-45-24-11, FA-45-24-11-Special and F-45-18-11-Kit for 0.2 mL PCR tubes, set of 6 for 0.4 mL tubes, set of 6 for 0.5 mL tubes and 0.6 mL Microtainer, set of 6

10.3.3 Other accessories

Order No. (International)	Order No. (North America)	Description
5416 301.001	022634305	Rotor key Standard
5703 350.102	022639609	Captain Eppi rotor key holder 1 piece
5404 850.085	5404850085	Tray for condensation water (only 5424 R)

10.4 Fuses

Order No. (International)	Order No. (North America)	Description
5424 852.122 5424 852.130	950004266 950004240	Fuses 3.15 AT for 230 V, 2 pieces 6.3 AT for 120 V/100 V, 2 pieces

Declarations and Certificates

EG-Konformitätserklärung EC Conformity Declaration

Das bezeichnete Produkt entspricht den einschlägigen grundlegenden Anforderungen der aufgeführten EG-Richtlinien und Normen. Bei einer nicht mit uns abgestimmten Änderung des Produktes oder einer nicht bestimmungsgemäßen Anwendung verliert diese Erklärung ihre Gültigkeit.

The product named below fulfills the relevant fundamental requirements of the EC directives and standards listed. In the case of unauthorized modifications to the product or an unintended use this declaration becomes invalid.

Produktbezeichnung, Product name:

Centrifuge 5424 / 5424 R

einschließlich Zubehör / including accessories

Produkttyp, Product type:

Laborzentrifuge / Laboratory Centrifuge

Einschlägige EG-Richtlinien/Normen, Relevant EC directives/standards:

2006/95/EG, EN 61010-1, EN 61010-2-020

2004/108/EG, EN 55011/B, EN 61000-6-1, EN 61000-3-2, EN 61000-3-3, EN 61326-1

98/79/EG, EN 14971, EN 61010-2-101, EN 61326-2-6

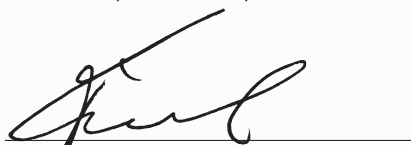

Vorstand, Board of Management:

26.11.2009

Hamburg, Date:



Projektmanagement, Project Management:

eppendorf



Eppendorf AG · Barkhausenweg 1 · 22339 Hamburg · Germany

Declarations and Certificates

Certificate of Compliance

Certificate Number 150705 - E215059
 Report Reference E215059, June 21st, 2005
 Issue Date 2005 July 15

Page 1 of 1



Issued to: **EPPENDORF AG**
BARKHAUSENWEG 1
22339 HAMBURG GERMANY

This is to certify that representative samples of **Centrifuge Model 5424**

Have been investigated by Underwriters Laboratories Inc.® in accordance with the Standard(s) indicated on this Certificate.

Standard(s) for Safety: **UL 61010A-1 - Electrical Equipment for Laboratory Use; Part 1**
UL 61010A-2-020 - Part 2: Particular Requirements for Laboratory Centrifuges
CSA C22.2 No. 1010.1-92 - Safety Requirements for Electrical Equipment for Measurement, Control and Laboratory Use; Part 1: General Requirements
CSA C22.2 No.1010.2-020-92, CSA C22.2 No. 1010.2-020A-97Part 2:Part Requirements for Laboratory Centrifuges

Additional Information: **ELECTRICAL RATING:**
Voltage: 120 V ac
Frequency: 50-60 Hz
Current: 3.8 A
Power: 220 W

Only those products bearing the UL Listing Mark for the US and Canada should be considered as being covered by UL's Listing and Follow-Up Service meeting the appropriate requirements for US and Canada.

The UL Listing Mark for the US and Canada generally includes: the UL in a circle symbol with "C" and "US" identifiers:  the word "LISTED"; a control number (may be alphanumeric) assigned by UL; and the product category name (product identifier) as indicated in the appropriate UL Directory.

Look for the UL Listing Mark on the product

Issued by: *Walter Hofmair*
Walter Hofmair, Senior Project Engineer
 UL International Germany GmbH
 Any information and documentation provided to you involving UL Mark services are provided on behalf of Underwriters Laboratories Inc.
 For questions in Germany, you may call +49 0 61 02 369 0.

Reviewed by: *Manfred Müller*
Manfred Müller, Senior Project Engineer
 UL International Germany GmbH

Declarations and Certificates

Certificate of Compliance

Certificate Number **20091210-E215059**
Report Reference **E215059-A1-UL-1**
Issue Date **2009 December 10**

Page 1



Issued to: Eppendorf A G

Barkhausenweg 1
Hamburg, 22339
Germany

This is to certify that representative samples of Laboratory Use Electrical Equipment
5424R

Have been investigated by Underwriters Laboratories in accordance with the Standard(s) indicated on this Certificate.

Standard(s) for Safety: UL 61010-1, 2nd Edition, Electrical Equipment for Measurement, Control, and Laboratory Use; Part 1: General Requirements
CAN/CSA-C22.2 No. 61010-1, 2nd Edition, Electrical Equipment for Measurement, Control, and Laboratory Use; Part 1: General Requirements

Additional Information: See UL On-line Certification Directory at WWW.UL.COM for additional information.

Only those products bearing the UL Listing Mark for the US and Canada should be considered as being covered by UL's Listing and Follow-Up Service meeting the appropriate requirements for US and Canada.

The UL Listing Mark for the US and Canada generally includes: the UL in a circle symbol with "C" and "US" identifiers:  the word "LISTED"; a control number (may be alphanumeric) assigned by UL; and the product category name (product identifier) as indicated in the appropriate UL Directory.

Look for the UL Listing Mark on the product

William Carney
Director, North American Certification Programs

Declarations and Certificates

Centre of Emergency Preparedness and Response
Health Protection Agency
Porton Down
Salisbury
Wiltshire SP4 0JG
United Kingdom



Certificate of Containment Testing

Containment Testing of Rotor FA 45-24-11
(5424 700.101-00, 50 x autoclaved at 121°C
for 20 minutes) in Eppendorf Centrifuge
5424 / 5424R

Report No. 73-08 A

Report prepared for: Eppendorf AG, Hamburg, Germany
Issue Date: 10th March 2008 (amended 24th Sept 2009)

Test Summary

Rotor FA 45-24-11 (5424 700.101-00, 50 x autoclaved at 121°C for 20 minutes) was containment tested in the Eppendorf 5424 / 5424R centrifuge, using Annex AA of IEC 1010-2-20. The rotor was shown to contain a spill within the rotor.

Report Written By

Anna May

Report Authorised By

[Signature]

Declarations and Certificates

Centre of Emergency Preparedness and Response
Health Protection Agency
Porton Down
Salisbury
Wiltshire SP4 0JG
United Kingdom



Certificate of Containment Testing

Rotor FA 45-24-11-Special
(5424 700.101-00) in Eppendorf centrifuge
5424 / 5424R

Report No. 959-05 B

Report prepared for: Eppendorf AG, Hamburg, Germany
Issue Date: 29th June 2005 (amended 24th Sept 2009)

Test Summary

The FA 45-24-11-Special rotor (5424 700.101-00) was containment tested in the Eppendorf centrifuge 5424 / 5424R, using Annex AA of IEC 1010-2-20. The rotor was shown to contain a large spill within the rotor.

Report Checked By

Anna May

Report Written and Authorised By

[Signature]

Eppendorf offices

AUSTRALIA & NEW ZEALAND

Eppendorf South Pacific Pty. Ltd.
Phone: +61 2 9889 5000
Fax: +61 2 9889 5111
E-mail: Info@eppendorf.com.au
Internet: www.eppendorf.com.au

AUSTRIA

Eppendorf Austria GmbH
Phone: +43 (0) 1 890 13 64 - 0
Fax: +43 (0) 1 890 13 64 - 20
E-mail: office@eppendorf.at
Internet: www.eppendorf.at

BRAZIL

Eppendorf do Brasil Ltda.
Phone: +55 11 30 95 93 44
Fax: +55 11 30 95 93 40
E-mail: eppendorf@eppendorf.com.br
Internet: www.eppendorf.com.br

CANADA

Eppendorf Canada Ltd.
Phone: +1 905 826 5525
Fax: +1 905 826 5424
E-mail: canada@eppendorf.com
Internet: www.eppendorfna.com

CHINA

Eppendorf China Ltd.
Phone: +86 21 38560500
Fax: +86 21 38560555
E-mail: market.info@eppendorf.cn
Internet: www.eppendorf.cn

CZECH REP. & SLOVAKIA

Eppendorf Czech & Slovakia s.r.o.
Phone: +420 323 605 454
Fax: +420 323 605 454
E-mail: eppendorf@eppendorf.cz
Internet: www.eppendorf.cz /
www.eppendorf.sk

FRANCE

Eppendorf France S.A.R.L.
Phone: +33 1 30 15 67 40
Fax: +33 1 30 15 67 45
E-mail: eppendorf@eppendorf.fr
Internet: www.eppendorf.fr

GERMANY

Eppendorf Vertrieb
Deutschland GmbH
Phone: +49 2232 418-0
Fax: +49 2232 418-155
E-mail: vertrieb@eppendorf.de
Internet: www.eppendorf.de

INDIA

Eppendorf India Limited
Phone: +91 44 42 11 13 14
Fax: +91 44 42 18 74 05
E-mail: info@eppendorf.co.in
Internet: www.eppendorf.co.in

ITALY

Eppendorf s.r.l.
Phone: +390 2 55 404 1
Fax: +390 2 58 013 438
E-mail: eppendorf@eppendorf.it
Internet: www.eppendorf.it

JAPAN

Eppendorf Co. Ltd.
Phone: +81 3 5825 2363
Fax: +81 3 5825 2365
E-mail: info@eppendorf.jp
Internet: www.eppendorf.jp

NORDIC

Eppendorf Nordic Aps
Phone: +45 70 22 2970
Fax: +45 45 76 7370
E-mail: nordic@eppendorf.dk
Internet: www.eppendorf.dk

SOUTH & SOUTHEAST ASIA

Eppendorf Asia Pacific Sdn. Bhd.
Phone: +60 3 8023 2769
Fax: +60 3 8023 3720
E-mail:
eppendorf@eppendorf.com.my
Internet: www.eppendorf.com.my

SPAIN

Eppendorf Ibérica S.L.U.
Phone: +34 91 651 76 94
Fax: +34 91 651 81 44
E-mail: iberica@eppendorf.es
Internet: www.eppendorf.es

SWITZERLAND

Vaudaux-Eppendorf AG
Phone: +41 61 482 1414
Fax: +41 61 482 1419
E-mail: vaudaux@vaudaux.ch
Internet: www.eppendorf.ch

UNITED KINGDOM

Eppendorf UK Limited
Phone: +44 1223 200 440
Fax: +44 1223 200 441
E-mail: sales@eppendorf.co.uk
Internet: www.eppendorf.co.uk

USA

Eppendorf North America, Inc.
Phone: +1 516 334 7500
Fax: +1 516 334 7506
E-mail: info@eppendorf.com
Internet: www.eppendorfna.com

OTHER COUNTRIES

Internet: www.eppendorf.com/worldwide



Evaluate your operating manual

www.eppendorf.com/manualfeedback

eppendorf
In touch with life

Your local distributor: www.eppendorf.com/worldwide

Eppendorf AG · 22331 Hamburg · Germany · Tel: +49 40 538 01-0 · Fax: +49 40 538 01-556 · E-Mail: eppendorf@eppendorf.com

Eppendorf North America, Inc. · 102 Motor Parkway, Suite 410 · Hauppauge, NY 11788-5178 · USA

Tel: +1 516 334 7500 · Toll free phone: +1 800 645 3050 · Fax: +1 516 334 7506 · E-Mail: info@eppendorf.com

Application Support

Europe, International: Tel: +49 1803 666 789 · E-Mail: support@eppendorf.com

North America: Tel: +1 800 645 3050 ext. 2258 · E-Mail: techserv@eppendorf.com

Asia Pacific: Tel: +60 3 8023 6869 · E-Mail: support_asiapacific@eppendorf.com