

# BioCLAVE™

---

## Operations Manual

For Research Use Only

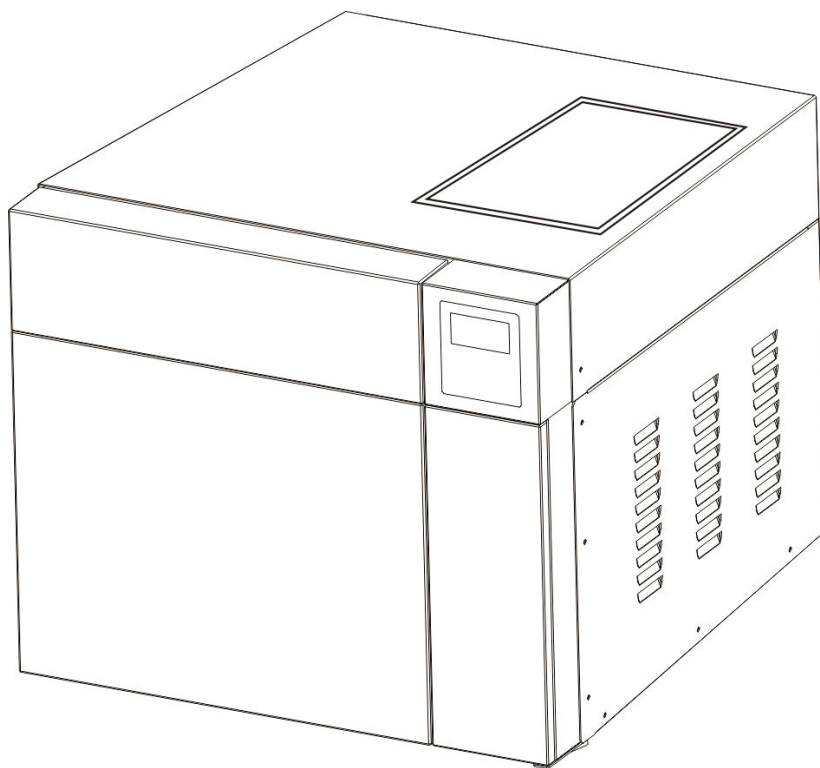

**Benchmark**   
Scientific

PH: 908-769-5555    EM: [info@BenchmarkScientific.com](mailto:info@BenchmarkScientific.com)

WEB: [www.BenchmarkScientific.com](http://www.BenchmarkScientific.com)



Thank you for choosing our steam sterilizers.

Prior to operating this instrument, please read the operations manual carefully and follow all installation instructions.

**IMPORTANT NOTICE:**

If you can't open the door, please unlock the door according to the instruction "How to open the door in the case of power outage" in the manual.

**Need Maintenance**

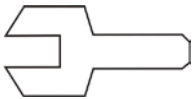

If this picture appears on the screen when power on or E88 appears on the report, please call your dealer or local service maintenance. Your steam sterilizer needs a regular maintenance.

Instructions Manual

B4000-28

Document: Version 07T10013 v2.8

Subjects to technical changes

# Table of Contents

<b>1. General</b>	<b>1</b>
1.1 Scope of manual	1
1.2 Intended use	1
1.3 General Safety Instructions	1
1.4 Standards and directives	1
1.5 Symbols	1
<b>2. Description of the autoclave</b>	<b>2</b>
2.1 Autoclave views	2
2.2 Control panel	2
2.3 Technical Specifications	3
2.4 Packing content	3
<b>3. Installation</b>	<b>4</b>
3.1 General conditions	4
3.2 Power supply connection	4
<b>4. Setup</b>	<b>4</b>
4.1 Basic set	5
4.2 Fill the distilled Water Tank	5
4.3 Preparation of the sterilization materials	5
<b>5. Operation</b>	<b>6</b>
5.1 Select the program	6
5.2 Running the sterilization program	6
5.3 Start the sterilization program	6
5.4 End of cycle	6
5.5 Manual abort the program	7
5.6 Record of the cycle	7
5.7 Printer	7
5.8 Report	7
<b>6. Advance settings</b>	<b>9</b>
6.1 Parameter	9
6.2 Ambient pressure	9
6.3 Unit	9
6.4 Preheat	9
<b>7. Maintenance</b>	<b>10</b>
7.1 Clean the distilled water tank	10
7.2 Clean Chamber, door seal, trays and tray Rack	10
7.3 Door adjustment	10
7.4 Replacement of the door seal	11
7.5 The drain valve	11
7.6 How to open the door in the case of power outage	11
<b>8. Error codes</b>	<b>12</b>
<b>9. Transportation and storage</b>	<b>13</b>
<b>10. Safety devices</b>	<b>13</b>
<b>Appendix 1 - Water properties / Characteristics</b>	<b>14</b>
<b>Appendix 2 - Diagrams of the sterilization programs</b>	<b>15</b>
<b>Appendix 3 - Wiring diagram</b>	<b>17</b>
<b>Appendix 4 - Hydraulic diagram</b>	<b>18</b>

## 1. General

### 1.1 Scope of Manual

This manual contains information concerning the installation, operation and maintenance of the steam sterilizers. To ensure proper performance of the autoclave, the instructions given in this manual should be thoroughly understood and followed. Keep the manual near to the sterilization in a readily accessible location for future reference.

### 1.2 Intended Use

The sterilizer described in this manual is intended for the sterilization of laboratory research tools and media. It operates automatically with 134°C and 121°C sterilization temperatures.

### 1.3 General Safety Instructions

- Read and understand this manual before attempting to install or operate the sterilizer.
- Make sure that all the installation conditions are fully complied with.
- Ensure that the supply voltage agrees with the supply voltage specified on the type plate of the sterilizer.
- This appliance must be grounded. Connect only to a properly grounded outlet.
- Do not cover or block any openings on this appliance.
- Use this appliance only for its intended use as described in this manual.
- Do not exceed the maximum weight limit of the loads specified in this manual.
- Do not operate this appliance if it has a damaged cord or plug, if it is not working properly, or if it has been damaged or dropped.
- Never must put into the sterilizer inflammables or explosives products.
- The sterilizer may not be operated in areas in which gas or any other explosive volatile substance is present.
- Installation and repair work should only be performed by authorized service technician. Work by unqualified persons could be dangerous and void warranty.

### 1.4 Symbols

For safe operation, please pay close attention to the alert symbols below which can be found in the sterilizer or throughout this manual.



This symbol represents an electrical caution - ground protection.



Hot Surface

This symbol represents a warning of a potential hot surface.



Important safety information.



This symbol represents a warning for extra caution.

## 2. Description of the sterilizer

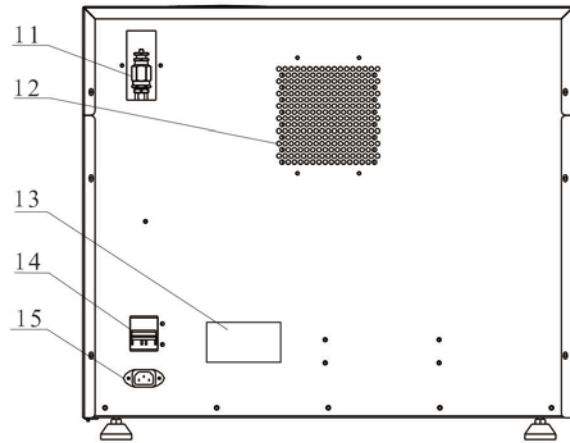
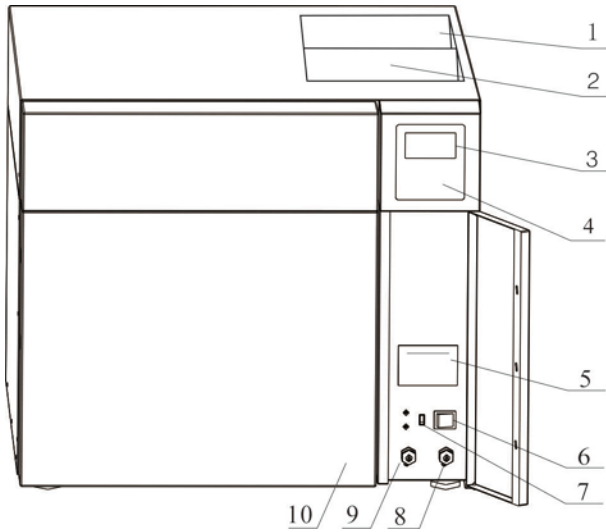
### 2.1 Sterilizer views



- 1. Used water tank
- 2. Distilled water tank
- 3. LCD
- 4. Control Panel
- 5. Printer (Optional)
- 6. Main power switch
- 7. USB port
- 8. Drain connector (Used water tank)
- 9. Drain connector (Distilled tank)
- 10. Door
- 11. Safety valve
- 12. Condenser ventilation
- 13. Rating plate
- 14. Circuit breaker
- 15. Power socket

	Date of manufacture
SN	Manufacture number
	Manufacturer Name
	Manufacturer Address

### 2.2 Control panel

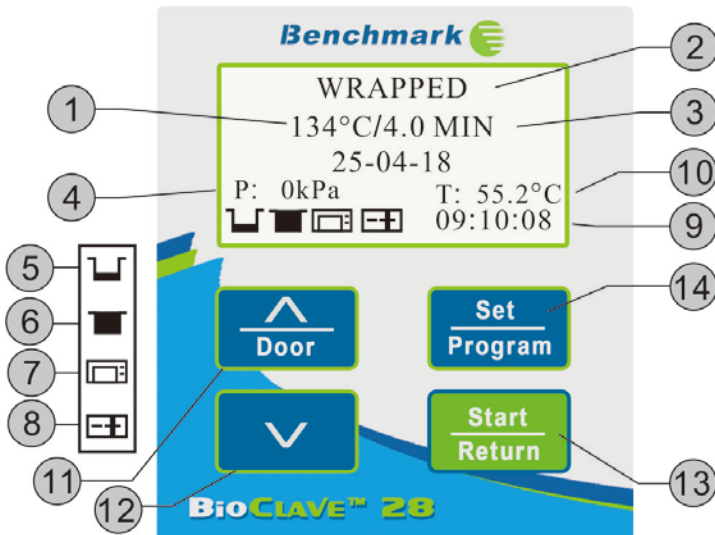

<b>1</b>	Temperature of the cycle
<b>2</b>	Program
<b>3</b>	Holding time
<b>4</b>	Pressure
<b>5</b>	Fill distilled water tank
<b>6</b>	Drain used water tank
<b>7</b>	Printer is connected
<b>8</b>	Door is closed
<b>9</b>	Time
<b>10</b>	Current temperature
<b>11</b>	Up button
<b>12</b>	Down button
<b>13</b>	Start button
<b>14</b>	Set button

## 2.3 Technical specifications

Item	Parameter
Chamber	φ 319mm x 417 mm (12.5 x 16.4 in.)
Rated Voltage	220V (200V to 245V) 50/60Hz
Circuit breaker	F16A/400V
Nominal power	2100VA
Sterilization temperature	121°C /134°C
Capacity of the distilled water tank	Approx 8.0 L (Water at level Max)
	Approx 1.5 L (Water at level Min)
Operation temperature	5°C-40°C
Operation relative Humidity	Max. 80%, non condensing
Overall dimensions	640mm(W)*560mm(H)*640mm(D)
Net weight	92 kg
Max. Noise level	<70 dB
Atmospheric pressure	76 kPa – 106 kPa

## 2.4 Packing content

No.	Accessory	Quantity
1	Instrument tray rack	1
2	Draining hose	2
3	Instructions manual	1
4	Door seal	1

### 3. Installation

#### 3.1 General conditions

Position the device on a flat and level surface with minimum capacity 60 kgs.

The sterilizer should be placed on a level worktable.

Improper water level in the chamber could cause a sterilizer malfunction.

Leave at least 10cm between the device rear part and the wall. The clearance required to open the door is 40cm.

Position the autoclave at such a height as to make it possible for the operator to check the whole sterilization chamber and carry out the normal cleaning operations.

The room where the device is installed must be enough ventilated.

Do not install the device near washing basins, taps, etc. where it is likely to be splashed.

Do not lean on the door when it is opened.

Do not place trays , papers, fluid containers, etc. on the sterilizer.

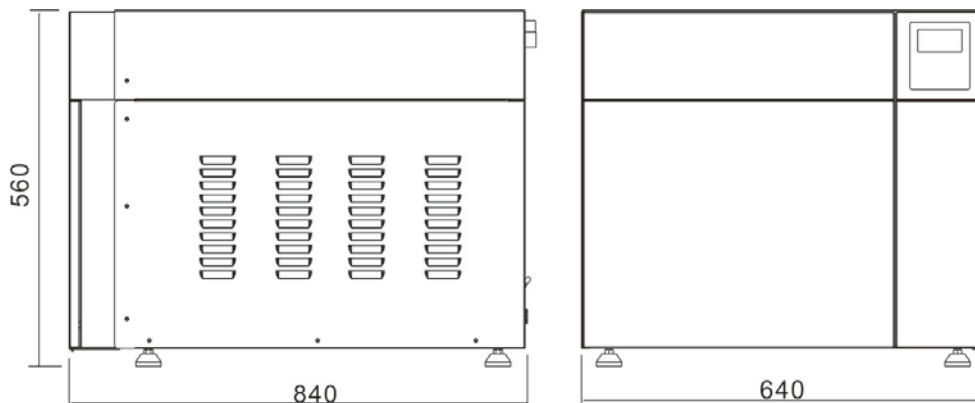

#### 3. 2 Power supply connection

Check the label on back panel o sterilizer to verify voltage rating for the unit. Failure to connect the autoclave to an appropriate power supply could result in damage to the unit, and electrical shock to personnel.

Plug power cord into a properly polarized and grounded receptacle rated. A dedicated circuit only used for the sterilizer is recommended.

Never connect the device pin to reductions of any type.

### 4 Setup

Open the door and remove all of the inner contents for unpacking.

Connect the power cord to an outlet of the appropriate voltage.

Turn on the main switch on the right side. After switching on, the machine turns on the LCD and shows the door position, water level, working program, date, time and etc.

Holding the up button for about 3 seconds, it will unlock the door.

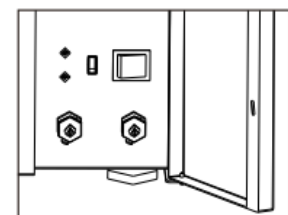

Note: The control panel will be locked for the initial 10 seconds after powering up for system initialization.

Notice: Before using the sterilizer or at any time the low water level icon  blinks, fill the distilled water tank with distilled water.



### 4.1 Basic Setting

The “Basic Setting” Menu permits to set the following options:

\*Date \*Time \*Language

Select the “Basic Setting” from the main menu and press the “Set” button.

Select the item by pressing the “Set” button. The unit you selected will be lighted.

Adjust the value by pressing the up or down buttons. Press the “Set” button to proceed to the next item.

After the language is set, then the data is permitted to be saved by pressing the “Set” button until the main menu appears.

Program  
Basic Set  
Report

DATE:23-04-17  
TIME:09:10:08  
LANGUAGE:ENG  
Counter:12

**Note:** If you want to cancel the setting and return to the main menu by pressing the “Start” button.

**Note:** The Counter (cycle No) can not be set by the operator.

Abbreviation of language options

CHN	Chinese	ENG	English	DEU	German	ESP	Spanish
PL	Polish	FR	French	HUN	Hungary	ROM	Romanian
NL	Dutch	LTU	Lithuanian	LAT	Latvian	CZE	Czech
ITA	Italian	RUS	Russian				

### 4.2 Fill the distilled water tank

Ensure that the drain valve is closed and open the water tank cover.

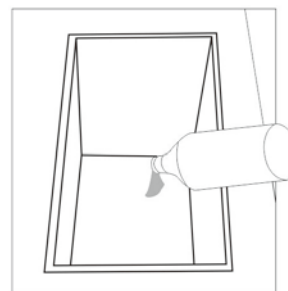
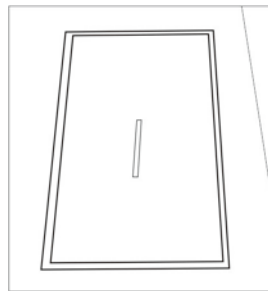

Use only distilled water. (see Appendix 1)

### 4.3 Preparation of sterilization materials

For the most effective sterilization and to preserve the sample, please follow below:

- \*Clean instruments immediately after use.
- \*Residual chemicals left over after cleaning and disinfecting process may damage and corrode parts of the autoclave, always rinse off the instruments using distilled water.
- \*Follow instrument manufacturer’s guidelines and recommendations for handling and cleaning instruments prior to sterilization.
- \*Check the manufacturer’s instructions as to proper procedure for sterilizing of each item.
- \*Arrange the samples of different materials on different trays or with at least 3cm of space between them.
- \*Clean and dry instruments thoroughly before placing them into tray.
- \*We recommend using sterilization paper (or cloth) between the tray and sample to avoid direct contact.
- \*Arrange the containers (glasses, cups, test-tubes, etc) on one side or inverted position, avoiding possible water stagnation.
- \*Don’t stack the trays one above the other or put them in direct contact with the walls of the sterilization chamber.
- \*Always use the instrument tray handle.
- \*Wrap the samples one by one or, if more tools have to be set in the same bag, verify that these are made of the same material.

\*Don't use metallic clips, pins or other, as this jeopardizes the maintenance of the autoclave.

\*Don't overload the trays over the stated limit (see appendix 2).

## 5. Operation

### 5.1 Select the program

Press the "Up" button to open the main menu, select "Program". You will see the available sterilization programs. See Appendix 2.

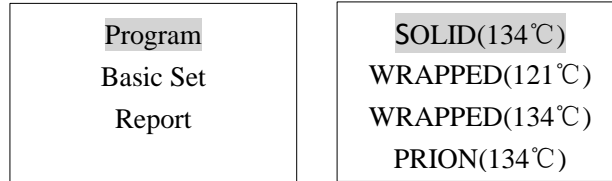

Select the program by up or down buttons and confirm it by pressing the "Set" button. If you don't want to select a program you may press the "Return" button to exit.

### 5.2 Running the sterilization program.

After selecting program, the instruments to be sterilized can now be placed on the tray placed inside the chamber.

5.2.1 After the instruments are loaded, you may close the door.

Push the door to be closed, holding for about three seconds, it will lock automatically.

Caution: The door can not be locked if the pressure is higher than 0 kPa. Please wait for the chamber cooling down.

### 5.3 Start the sterilization program.

After the "Start" button is pressed, the stage and the status of the current cycle will appear on the display. The sterilizers will perform the program automatically. (see appendix 2).

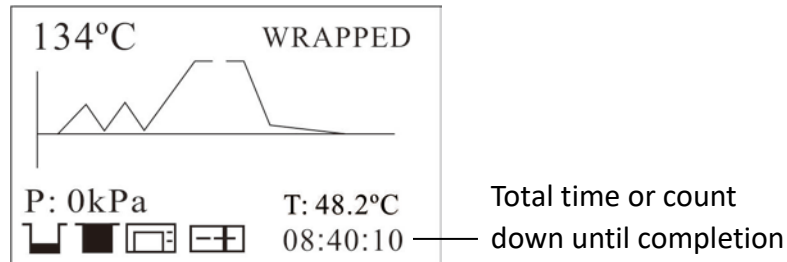

### 5.4 End of cycle

After cycle is completed, the printer will be activated and print out a report of the cycle (if the optional printer has been connected) or save the report in the USB drive (optional).

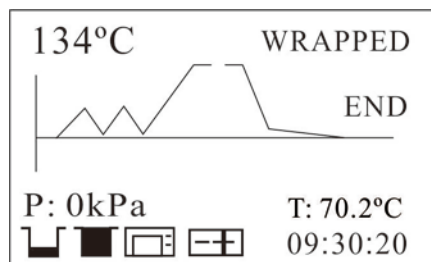

Caution: Always use the tray handle to load or unload the tray into the autoclave. Failure to do so can result in burning.

### 5.5 Manual abort of the program

It is possible to interrupt a started cycle prematurely. If you need to interrupt a cycle and remove the items urgently, you may hold the “Start” button for 3 seconds. (If held for 3 seconds during the drying time, this will skip the dry cycle.

If you interrupt any cycle before it reaches the “Drying” step, then the items inside the autoclave must be considered not sterile.



If you need to interrupt a cycle after the holding time of the sterilization cycle and during the drying step then the items inside the autoclave can be considered sterilized.



Caution: Depending on the status of the Cycle, when the door is opened, steam may escape the chamber.

### 5.6 Record of the cycle

USB Flash memory (Optional)

A USB drive can be used as a method of storing a report of the cycle. To do so, insert the USB drive into the slot located on the service door of the sterilizer.

The information will automatically output directly to the USB drive after the cycle has completed. The name of the file is determined by the serial number of the machine and the cycle number.

For example:

The serial number is E00001. The cycle number is 0012.

The file name in the USB stick is 01001200.txt.

The first two numbers represent machine number.

The middle four numbers represent cycle number.

The last two numbers represent error code.

E.g. 00:no error;01: error E01

### 5.7 Printer (Optional)

If installed you can see the Icon in the screen stop flashing.

The printer (Optional) will produce a report of the cycle that just ended. T the end of each cycle the printer will print out a report of the cycle.

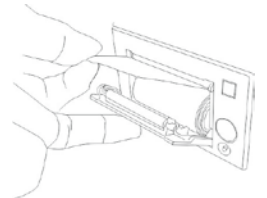

### 5.8 Report

Internal Memory

In this menu you can read the latest information of the last 20 cycles stored in the internal memory of the sterilizer.

5.9.1 Select “Report” from the main menu and press the Set” button, you will see the list of records.

5.9.2 Select the record by pressing the up or down buttons.

5.9.3 Press the “Set” button.

Then the record is printed (if the optional printer has been connected) the report or/and is saved in the USB drive (optional).

Note: It can save in the internal memory only the reports of the last 20 cycles.

Note: The storage system is based on the principle of “first In-first-out”.

Tap start button to exit.

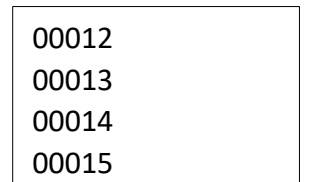
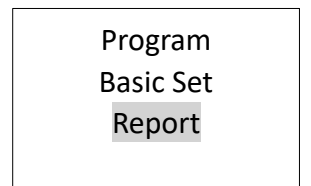

When vising printed data records, refer to the diagram below:

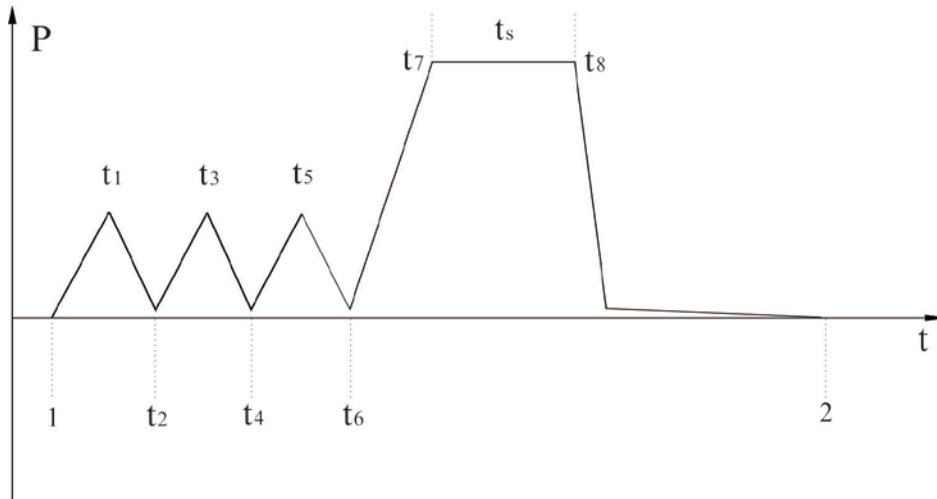

```

=====
Program:      WRAPPED
Temperature:  134C
Pressure:     206.0 kPa
Dry Time:     02Min
Ster Time:    4.0Min
-----
          time    temp.  pressure
Start  15:24:20  042.0C
T1:    15:32:11  070.0C  053.2kPa
T2 :   15 :36 :08  075.3C  009.7kPa
T3 :   15 :39 :21  090.3C  050.4kPa
T4 :   15 :44 :32  094.3C  009.6kPa
T5 :   15 :47 :12  119.0C  102.4kPa
T6 :   16 :00 :11  110.2C  009.3kPa
TS :                   134.8C  221.6kPa
MAX.Temperature:135.1C
MIN.Temperature:134.5C
MAX.Pressure :230.4kPa
MIN.Pressure :212.9kPa
T7 :   16 :04 :02  135.0C  223.5kPa
T8 :   16 :06 :32  134.8C  214.1kPa
End 16:14:12    78.2C
-----
Cycle No: 0005
Ster Value: Success
Date: 2011-01-18
SN:E00001
Operator:
=====
    
```

## 6. Advance setting

The advance setting interface permits to set the following

Options:

**\*Parameter:** Permits to change the time of Holding time and Drying time.

**\*Unit:** Permits to change the unit of measure temperature and pressure.

**\*Preheat:** This option allows you to maintain the required temperature in the sterilization chamber and the steam generator to start a new cycle immediately for the next 60 minutes so to run a new cycle should expect preheating time from 3 to 5 minutes upon start.

If the option is disabled (OFF) once the sterilization cycle end immediately the Autoclave is no longer heated, so when you start a new cycle should expect a preheating time between 3 to 5 minutes upon start.

**Note:** To maintain the temperature for longer time it is recommended that after each cycle hold the door closed.

### Enter the setting

Power on the machine while holding the set button and hold for 5 seconds. This will enter into the advanced setting mode.

#### 6.1 Parameter

Press up or down buttons to select Parameter. Press "Set" button to enter the menu.

Select the program that you need to change by pressing the up or down buttons. Press "Set" button to enter the setting.

Adjust the parameter by pressing the up or down buttons.

Drying time: 0-20 minutes

121°C holding time: 1-60 minutes

134°C holding Time: 1-20 minutes

After you finish adjusting the parameter Press the "Set" button to save and return to the above menu. Press the "Start" button to cancel and exit.

Parameter  
Unit  
Preheat

SOLID(121°C)  
SOLID(134°C)  
WRAPPED(121°C)  
WRAPPED(134°C)

Holding Time: 20.0  
Dry Time: 02

#### 6.2 Ambient pressure

Select the "Ambient Pressure" to calibrate the local ambient pressure to 0.

Tap set button to enter the menu.

Make sure the pressure inside the chamber had been balanced.

Press the "Set" button to calibrate the pressure.

Press the "Return" button to cancel and exit.

Ambient Pressure  
Offset: 0.1

#### 6.3 Unit

Select the "Unit" to adjust the unit of temperature and pressure.

Press the "Set" button to enter the menu.

Select the item by pressing the "Set" button.

Change the unit by pressing the up or down buttons.

Pressure: kPa/bar/psi

Temperature: °C/F

Press the "Set" button to save and exit. Cancel and Exit by pressing the "Return" button.

Pressure: kPa  
Temperature: C

#### 6.4 Preheat

Select the "Preheat" to adjust the Preheat.

Press the "Set" button to enter the menu.

If you prefer not to activate the automatic preheating, set the value to "OFF" by pressing the up or down buttons.

Press the "Set" button to save. Tap start button to cancel and exit.

Preheat: ON

## 7. Maintenance

To assure proper operation and maximum autoclave life, carefully follow all recommendations for periodic maintenance. One of the MOST important steps you can take to prevent problems with your sterilizer is to use ONLY distilled water.

Frequency	Number of cycles	Maintenance operation
Monthly	50	Clean the door seal
		Clean the filter inside the chamber and in the clean water tank
		Clean the chamber the trays and the rack
		Clean the external surface
Every 3 months	200	Clean the distilled water tank
Every year	800	Replace the door seal

### 7.1 Clean the distilled water tank

Disconnect the main cable.

Drain the tank completely using the drain tube and leave it connected into the connector in a open position.

Clean the internal surface with a soft sponge and a small soft brush for the areas that are difficult to reach using and a mild soap.

Remove the filter and clean it with a small soft brush and mild soap, rinse it with distilled water and put it back in to the position.

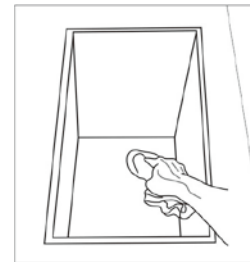

### 7.2 Clean Chamber, door seal, trays and tray Rack.

Remove the trays and tray rack from the chamber.

Clean trays, rack and inside of chamber with mild soap.

Rinse the trays, rack and inside of chamber with a smooth cloth distilled water.

Examine door seal for possible damage.

Clean door seal and mating surfaces with a damp cloth.

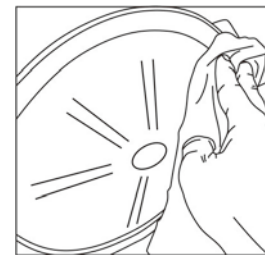
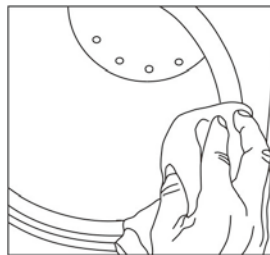

and

Note: Do not use bleaching agents or any abrasive materials / substances in chamber. Failure to comply may result in damage to the chamber and/or other components.



Caution: To prevent burns, let unit to cool before cleaning gaskets and touch the surface.

### 7.3 Door adjustment

Under normal circumstances the chamber door does not require adjustments. However, if the seal fails (resulting in steam leaking from the front of the chamber), you may use the spanner tool to tighten the door seal.

7.4.1 Open the door.

7.4.2 Insert the spanner in the hole. Loose the screw anticlockwise.

Tighten the door by rotate the lid counter-clockwise. Loosen the door by rotate the lid clockwise as the figure below.

7.4.3 Tighten the screw clockwise.

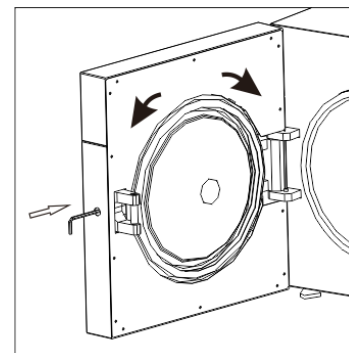

Caution: Never adjust the chamber door while the door is closed.

### 7.4 Replacement of the door seal

Open the chamber door. Remove the door seal ring carefully by hand.

Clean the door seal ring carefully with a smooth cloth with distilled water.

Moisten the new seal with medical disinfectant or isopropyl alcohol.

Insert the new seal and press in sequence as follows:

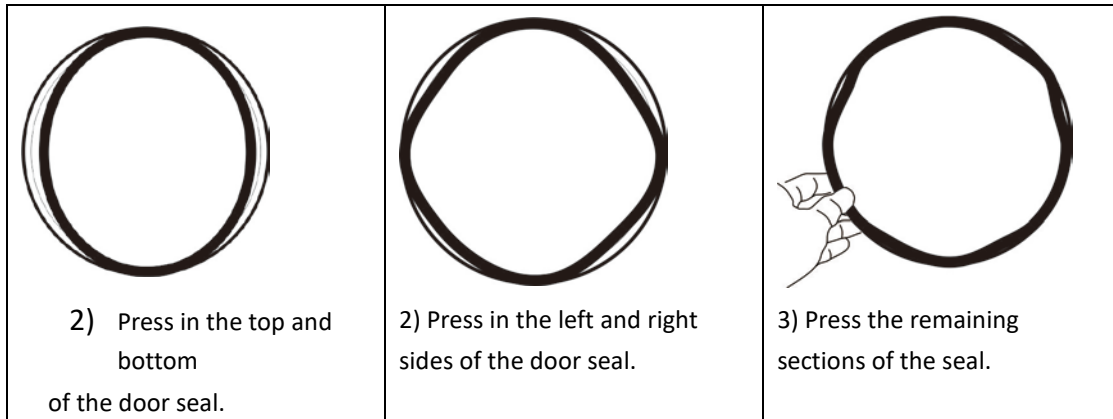

Caution: Please ensure the chamber and the door are cooled prior to replacing the seal ring.

### 7.5 The drain valve

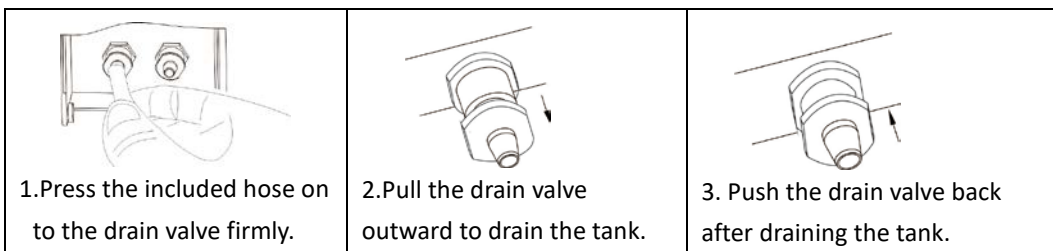

## 8. Error codes

Code	Description	Proposed solution
E1	Steam generator temperature sensor error	Power off & run a new cycle Contact your supplier if error persist
E2	Inner temperature sensor error	Power off & run a new cycle Contact your supplier if error persist
E3	Temperature sensor of the chamber wall error	Carefully ensure that the chamber wall is heated and contact your supplier
E5	Fail to release the pressure	Power off & run a new cycle Contact your supplier if error persist
E6	Door lock problem during the cycle	Check the door close switch.
E9	Failure to hold temperature	Ensure the distilled tank isn't empty. Check the inner temperature sensor. Check somewhere for leaking.
E11	Failure to preheat the steam generator	Power off & run a new cycle Contact your supplier if error persist
E12	Failure to preheat the chamber	Power off & run a new cycle Contact your supplier if error persist
E20	Program manually interrupted	Holding the set button for 3 seconds
E21	Failure to reach the holding time. (sterilization time)	Check somewhere leaking inside the autoclave. Contact your supplier if error persist
E23	Result of vacuum test is void	The temperature of the chamber is high. Try again after the chamber has cooled down.
E24	It takes too long time to enter the next status.	Check somewhere leaking. Or contact your supplier if error persists.
E25	There is a problem of locking the door.	The door is too tighten. Or Check the door locking switch. Check the door motor. Contact your supplier if error persists.
E26	There is a problem of unlocking the door.	Check the door unlocking switch. Check the door motor. Contact your supplier if error persists.
E28	The pressure is over 240kPa	Power off and contact your supplier if error persists
E32	The pressure is not lower than -1 kPa in 30 seconds during locking the door.	Power off and contact your supplier if error persists
E33	The pressure is not lower than 1 kPa in 30 seconds during unlocking the door.	Power off and contact your supplier if error persists

Caution: You may cancel the voice of alarm by taping any button. And cancel the alarm by holding the set button for 3 seconds after you repair it. Then swith off and switch on again.



## 9. Transportation and storage

9.1 Switch off the sterilizer before transportation or storage.

9.2 Pull out the plug. Let the machine cool down.

9.3 Drain the distilled water tank and the used water tank.

Condition for transport and storage

Temperature: -20°C ~ +50°C

Relative humidity: ≤ 85%

Atmospheric pressure: 50kPa~ 106kPa.

## 10. Safety devices

1.Main fuses: Protection the instrument against possible failures of the heating resistor.

Action: Interruption of the electric power supply.

2.Thermal cutouts on the main transformer windings: protection against possible short circuit and main transformer primary winding overheating

Action: Temporary interruption of winding.

3.Safety valve: Protection against possible sterilization chamber over-pressure.

Action: Release of the steam and restoration of the safety pressure.

4.Safety micro-switch for the door status: Comparison for the correct closing position of the door.

Action: Signal of the wrong position of the door

5.Thermostat on chamber heating resistors: Protection for possible over heating of the chamber heating resistors.

Action: Interruption of the power supply of the chamber resistors.

6.Thermostat on steam generator heating resistors: Protection for possible overheating of the steam generator heating resistors.

Action: Interruption of the power supply of the steam generator resistors.

7.Door safety lock: Protection against accidental opening of the door.

Action: Impediment of the accidental opening if the door during the program.

8.Self-leveling hydraulic system: Hydraulic system for the natural pressure leveling in case of manual cycle interruption, alarm or black-out.

Action: Automatic restoration of the atmospheric pressure inside chamber.

## Appendix 1

## Water properties / Characteristics

Description	Feed water	Condensate
Evaporate residue	≤ 10mg/ l	≤ 1.0mg/kg
Silicium oxide sio2	≤ 1mg/ l	≤ 1.0mg/kg
Iron	≤ 0.2mg/ l	≤ 0.1mg/kg
Cadmiun	≤ 0.005mg/ l	≤ 0.05mg/kg
Lead	≤ 0.05mg/ l	≤ 0.1mg/kg
Rest of heavy metals	≤ 0.1mg/ l	≤ 0.1mg/kg
Chloride	≤ 2mg/ l	≤ 0.1mg/kg
Phosphates	≤ 0.5 mg/ l	≤ 0.1mg/kg
Conductivity	≤ 15µs /cm	≤ 3 µs /cm
PH Value	5 – 7.5	5-7
Appearance	Colorless, clean	Colorless, clean
Hardness	0.02 mmol/ l	0.02 mmol/ l

**Appendix 2**

**Diagrams of the sterilization programs**

Programs	Temperature (°C)	Pressure (Kpa)	Holding time	Total time (min)	Type	Max load (kg)	Max load per tray (kg)
UNWRAPPED	134	210	4	25-40	Unwrapped solid material	6.0	2.0
	121	110	20	25-40			
WRAPPED	134	210	6	33-53	Unwrapped porous material	3.5	2.0
					Single-wrapped porous material	3.0	2.0
	121	110	20	30-50	Dual-wrapped porous material	2.5	2.0
					Single-wrapped hollow material	4.0	2.0
					Dual-wrapped solid and hollow material	3.5	2.0
TEXTILE	134	210	10	37-57	Unwrapped porous material	3.5	2.0
					Single-wrapped porous material	3.0	2.0
					Dual-wrapped porous material	2.5	2.0
	121	110	30	40-60	Single-wrapped hollow material	4.0	2.0
					Dual-wrapped solid and hollow material	3.5	2.0
(Extensive) PRION	134	210	18	45-65	Unwrapped porous material	6.0	2.0
					Single-wrapped porous material	3.5	2.0
					Dual-wrapped porous material	3.0	2.0
					Single-wrapped hollow material	2.5	2.0
					Dual-wrapped solid and hollow material	4.0	2.0
LIQUID	134	210	10	60-80	Liquid	4.0	4.0
LIQUID	121	110	30	60-80	Liquid, agar	4.0	4.0
DRYING	—	—	—	1-20	—	—	—

The time required for sterilizer to be ready for routine use after the power is switched is less than 5 minutes.

The max. Temperature of the 134°C sterilization cycle is 137°C

The max. Temperature of the 121°C sterilization cycle is 124°C

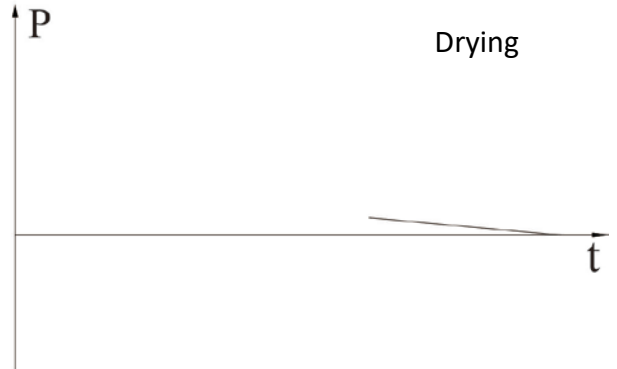
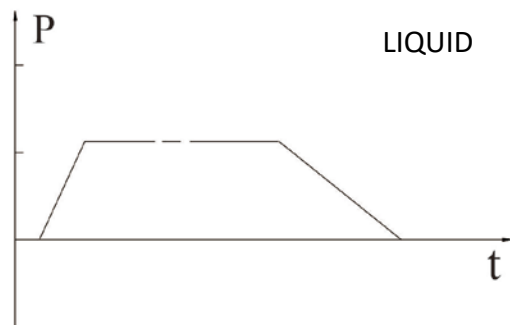
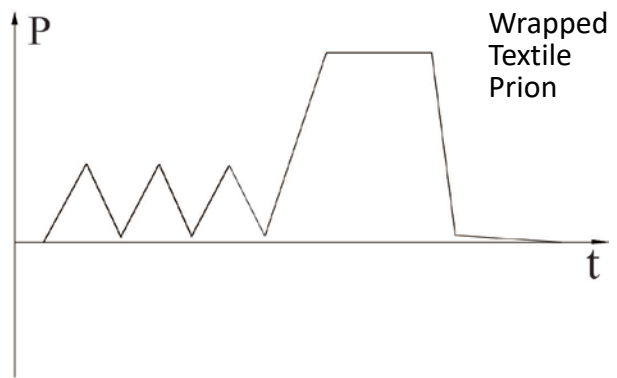
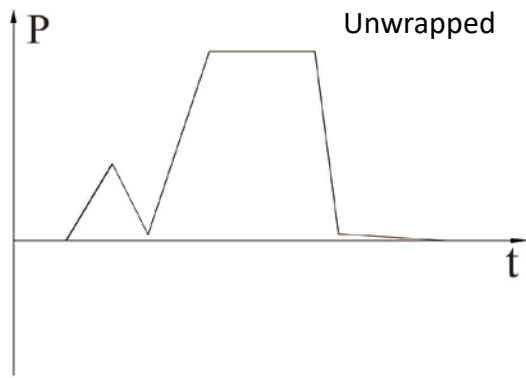

Appendix 3

Wiring diagram

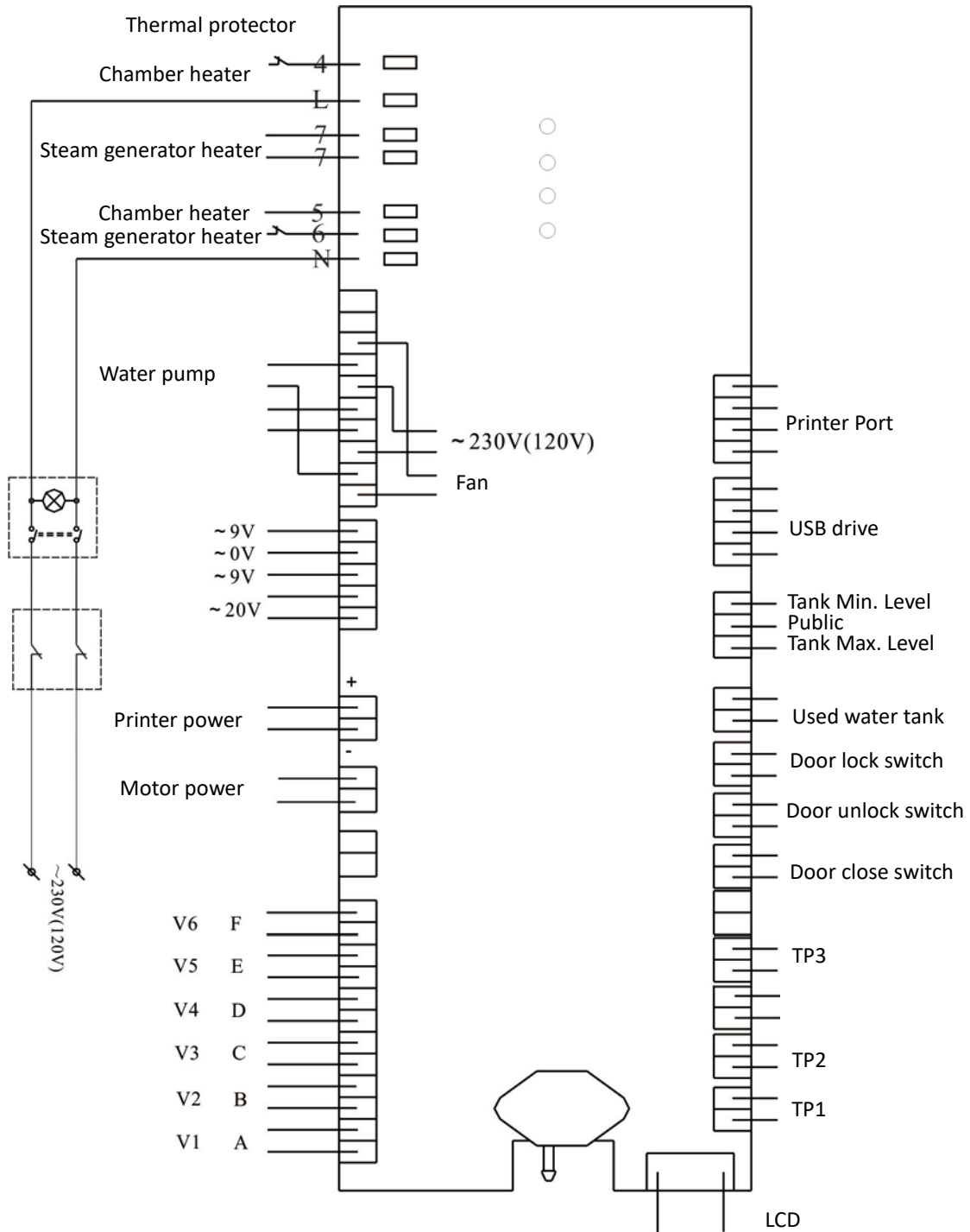

- TP1: Steam generator temperature sensor
- TP2: Inner temperature sensor
- TP3: Temperature sensor of chamber wall
- V1: Air release valve
- V4: Water release valve

Appendix 4

Hydraulic diagram

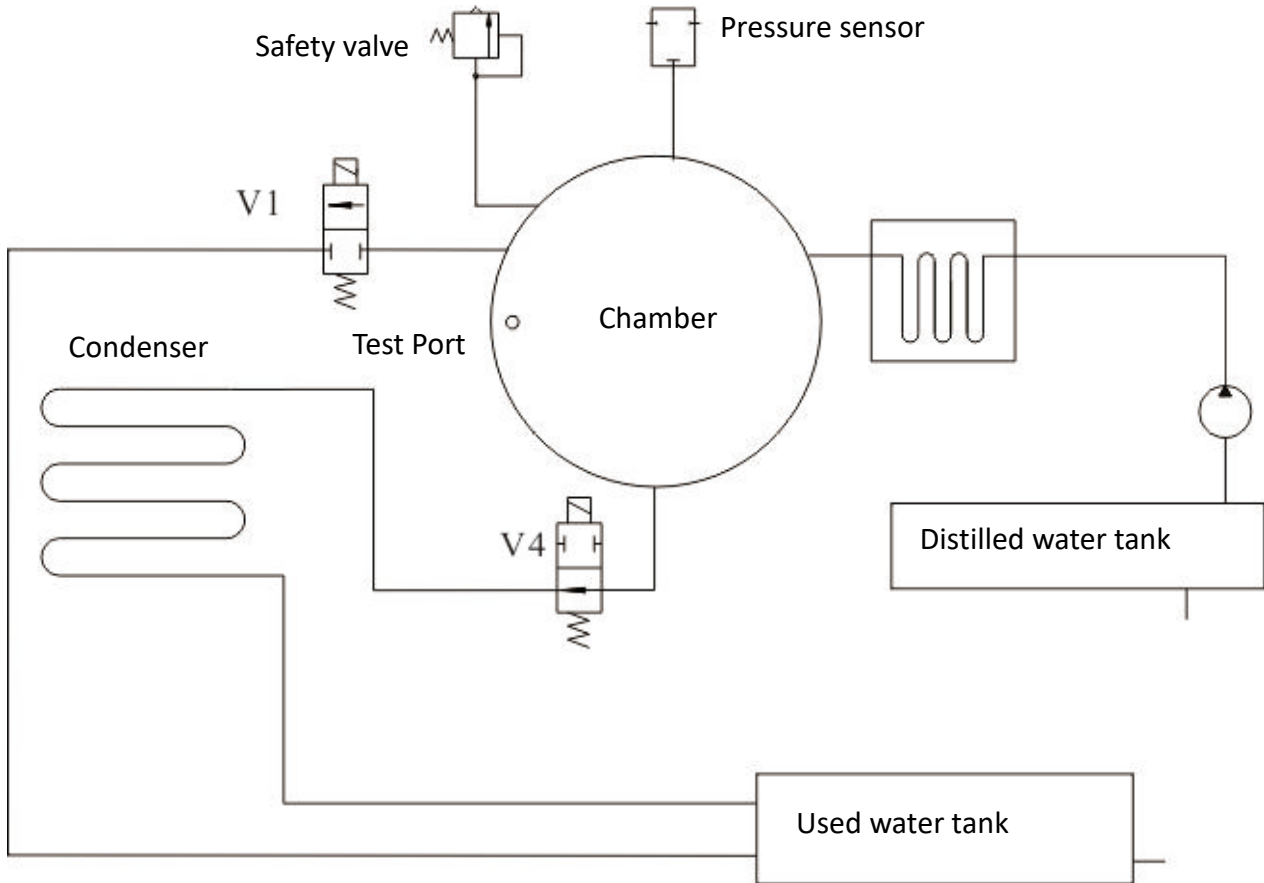

V1: Air release valve

V4: Water release valve